



International Trade Centre

Product and market development



Cotton Exporter's Guide





International Trade Centre

Product and market development



UNCTAD CNUCED



WTO OMC

Cotton Exporter's Guide

Geneva 2007

ABSTRACT FOR TRADE INFORMATION SERVICES

2007

SITC 263
COT

INTERNATIONAL TRADE CENTRE UNCTAD/WTO

Cotton Exporter's Guide

Geneva: ITC, 2007. xxvii, 334 p. (Product and market development)

Guide providing a comprehensive view of all aspects of the cotton value chain from a market perspective – provides an overview of the world cotton market (production, consumption and trade); outlines factors influencing supply and demand, and market trends; considers major issues of the sector, including trade policy and WTO issues; deals with textile processing of cotton, cotton quality and its determinants, and cotton contamination; covers various aspects of cotton trading and export marketing (packaging, controlling, back office and documentation, freight and shipping, financing, warehousing, insurance, risk management, contracts and arbitration); looks at e-commerce (Internet auction and electronic paperwork), the ICE Futures U.S. and other futures markets for cotton; reviews the market for different types of cotton, including organic cotton; presents market profiles of the main importing countries in Asia (Bangladesh, China, India, Indonesia, Pakistan, Thailand) and Turkey, with recommendations on how to approach their cotton-consuming textile industries; annexes contain a list of international cotton associations, as well as lists of useful addresses and web resources.

Descriptors: Cotton, Export Marketing, Electronic Commerce, Commodity Markets, Market Surveys, Textiles, Bangladesh, China, India, Indonesia, Pakistan, Thailand, Turkey.

English, French, Spanish (separate editions)

ITC, Palais des Nations, 1211 Geneva 10, Switzerland

The Government of Denmark financed the preparation and publication of this guide.

The designations employed and the presentation of material in this publication do not imply the expression of any opinion whatsoever on the part of the International Trade Centre UNCTAD/WTO concerning the legal status of any country, territory, city or area or of its authorities, or concerning the delimitation of its frontiers or boundaries.

Mention of firm names and commercial products does not imply the endorsement of ITC.

Digital image on the cover: Peter Wakefield and International Trade Centre

© International Trade Centre UNCTAD/WTO 2007

All rights reserved. No part of this publication may be reproduced, stored in a retrieval system or transmitted in any form or by any means, electronic, electrostatic, magnetic tape, mechanical, photocopying or otherwise, without prior permission in writing from the International Trade Centre.

ITC/P218.E/PMD/MDS/07-XI

ISBN 92-9137-352-4
United Nations Sales No. E.08.III.T.1

Foreword

There is no doubt that cotton has become a litmus test for the development dimension of WTO Doha Development Agenda (DDA), launched in 2001. It was in 2003 that the issue of cotton tariffs, domestic and export subsidies was brought to the fore by the Cotton-4 (Benin, Burkina Faso, Chad and Mali) with the support of the African Union, the least developed countries, and the African, Caribbean and Pacific countries.

In 2004, WTO Members agreed to establish a two-track process for the treatment of cotton: a trade track and a development track. The trade track, which forms part of the Doha Round, is aimed at negotiating the level of reduction of trade-distorting subsidies, export subsidies and tariffs on cotton. Agreement was reached to tackle cotton ambitiously, expeditiously, and specifically within the agriculture negotiations. The most notable progress made on this particular track since the launch of the negotiations took place at the Hong Kong Ministerial Conference in December 2005, where WTO Members agreed on the complete elimination of export subsidies for cotton, and on the granting of duty-free quota-free (DFQF) access for cotton to all exports from least developed countries. The development track is aimed at better targeting development assistance to cotton producing developing countries, and in particular the poorest among them. In March 2007, I convened a High-Level Session on Cotton to take stock of all action taken so far along both tracks. A conclusion unanimously reached by WTO Members at the High-Level Session was that there would be no outcome to the Doha Round without an outcome on cotton.

Since 2004, the International Trade Centre (ITC) has made a valuable contribution on the development aspects of cotton, notably by putting forward the idea of a *Cotton Exporter's Guide*. This guide is intended to serve as a reference on the global cotton market for the business community, at every level of the cotton value chain. It identifies niche areas, such as the demand for organic and other cotton varieties, and sets out in simple terms the market requirements for cotton exporters. In so doing, it draws attention to new export opportunities in many dynamic cotton markets, in particular in Asia. I believe that this is extremely valuable. The information contained in the guide will, no doubt, be of value for policy-makers as they design policies for cotton sector export development.

As progress continues to be made in the Doha Round on the trade policy aspects of cotton, I commend Patricia Francis and her team at ITC for their important contribution to the implementation of the WTO mandate on the development aspects of cotton. This is a vital complement to the outcome of the DDA.



Pascal Lamy
Director-General
World Trade Organization

The *Cotton Exporter's Guide* is a reference book that contains pragmatic and operational information on the international cotton market. The objective is to provide all those engaged in producing and exporting cotton with a thorough and down-to-earth understanding of all aspects of the international cotton trade.

This guide is primarily targeted at cotton producers, ginnerers, exporters and traders in cotton producing developing countries, mainly, but not exclusively, in Africa. As the guide provides a comprehensive view of all aspects of the cotton value chain from a market perspective, it will also help government officials to gain a deeper understanding of the crucial aspects that need to be addressed in cotton export development.

The *Guide* covers all the essential components of the cotton trade. Its ambition is to meet the needs of today's exporters who face many challenges – commercial, technical, logistical, environmental and social – in an increasingly sophisticated and competitive trading environment.

ITC's view is that for exporters to become internationally competitive, they need to have a comprehensive overview of the entire value chain they are operating in. The guide reflects this view entirely.

The Guide provides an important element of what is required to increase competitiveness in a global sector that is influenced by market adjustments after the quota phase-out in the textile and clothing sector.

ITC Cotton Programme, developed following the market adjustments, seeks to build capacity among cotton growers, ginnerers and exporters through a comprehensive 5-step market-oriented programme:

1. Delivery of an awareness building programme to African cotton growers and traders through the dissemination of and training on the Guide.
2. The design and implementation of a capacity building strategy to strengthen cotton-specific Trade Support Institutions, such as the African Cotton Association, to reach out to all of the 33 African cotton producing countries.
3. Implementation of a Cotton Training Programme together with developing countries that have successfully developed their own cotton sector, such as India, China and Brazil, etc. African cotton producers will, thus, learn from best practice around the world and will benefit from South-South knowledge transfer in areas such as cotton production management, processing, value addition as well as international cotton trade, etc.
4. Implementation of a textile and clothing awareness programme for cotton producers so that the latter better understand the immediate market for cotton and its requirements. Such a programme will be organized in textile producing (and thus cotton consuming) markets. It will also provide insights into value-addition possibilities and best practices mainly from Asia.
5. The promotion of African cotton to the booming textile industry in Asia. This includes business networking events, a series of South-South round tables and technical workshops in partnership with the African Cotton Associations and Textile Manufacturer Associations in the respective markets to facilitate networking and share experiences and best practices.

In all its activities, ITC will involve the cotton industry, including international traders and draw upon their expertise. The market is always the starting point of ITC's operations.



Patricia Francis
Executive Director
International Trade Centre

Acknowledgements

The main contributors of this guide were:

- ❑ Gérald Estur, coordinator, editor and collaborating author, international cotton trade consultant, former Statistician of the International Cotton Advisory Committee (ICAC), Washington, DC, USA, and previously General Manager of Compagnie Cotonnière (COPACO), Paris, France.
- ❑ Matthias Knappe (coordination, strategic direction and management); Chief, Market Development Section, International Trade Centre UNCTAD/WTO (ITC), Geneva.

This guide was made possible through the voluntary contributions of expertise, experience, insider knowledge and valuable time by the people, companies and organizations below, whose assistance is acknowledged with thanks and appreciation.

Chapter 1: The World cotton market

- ❑ Michael Edwards, Director, Cotton Outlook, Cotlook Limited, Liverpool, United Kingdom
- ❑ Chiedu Osakwe, Director of the Doha Development Agenda Special Duties Division, World Trade Organization (WTO), Geneva, Switzerland
- ❑ Terry Townsend, Executive Director, Armelle Gruère, Statistician, Alejandro Plastina, Economist, Andrei Guitchounts, Economist, International Cotton Advisory Committee (ICAC), Washington, District of Columbia, USA

Chapter 2: Cotton value addition

- ❑ W. Stanley Anthony, President and Chief Executive Officer, Enhanced Technologies, Inc., Greenville, MS, USA; Supervisory Agricultural Engineer/Research Leader, Cotton Ginning Research Unit, Agricultural Research Service, United States Department of Agriculture, Stoneville, Mississippi, USA (Retired)
- ❑ David M. Clapp, Fiber Processing Technical Services, Cotton Incorporated, Cary, NC, USA
- ❑ Cotton Incorporated, Raleigh, NC, USA
- ❑ Axel Drieling, Senior Manager, Cotton; Member of the Executive Board, Faserinstitut Bremen e.V.
- ❑ Dean Ethridge, Managing Director, Eric F. Hequet, Associate Director, International Textile Center, Texas Tech University, Lubbock, Texas, USA
- ❑ Lawrance Hunter, Nelson Mandela Metropolitan University and CSIR Materials Science and Manufacturing, Port Elizabeth, South Africa
- ❑ International Textile Centre – Texas Tech University, Lubbock, Texas, USA
- ❑ James Knowlton, Chief, Standardization & Engineering Branch, USDA, AMS, Cotton Program, Memphis, TN, USA
- ❑ Andrew G. Jordan, Private Consultant in Agricultural and Biological Engineering Solutions; former Vice President of Technical Services Division for the National Cotton Council of America
- ❑ M.N. Vijayshankar, Vice President, PT Apac Inti Corpora, Semarang, Indonesia

Chapter 3: Cotton marketing

- ❑ John R. Beck, Director General, The International Cotton Association Limited, Liverpool, United Kingdom
- ❑ Rupert Cutler, Associate Director – Special Risks, Miller Insurance Services Limited, London, United Kingdom
- ❑ Dunvanant SA, Geneva, Switzerland
- ❑ Hein Jan van Hilton, Commodity Development Consultant, Pennington, South Africa
- ❑ International Cotton Association Limited, Liverpool, United Kingdom
- ❑ Gérard Kassarian, Président, Association Française Cotonnière, Le Havre, France
- ❑ Simon McHattie, Administration Manager, Plexus Cotton Ltd., Liverpool, United Kingdom
- ❑ Gideon E. Onumah, Agricultural Economist/Rural Finance Specialist, Natural Resources Institute (NRI), University of Greenwich, Chatham Maritime, United Kingdom
- ❑ Jagdish Parihar, Managing Director, Cotton Department, Olam International Limited, Singapore
- ❑ Rabobank, The Netherlands
- ❑ Jeffrey Silberman, Executive Director, International Forum for Cotton Promotion (IFCP), Washington, DC, USA; Chairperson, Textile Development and Marketing Department, Fashion Institute of Technology (FIT), New York, NY, USA
- ❑ Derek A. Tanner, D.A.T. Arbitration and Consultancy, Senior Vice President, Newbridge Trading Corporation, United Kingdom, past President of the Liverpool Cotton Association (LCA)
- ❑ Rob van Uffelen, GM Global Hazardous Cargo Management, Maersk Line, Rotterdam, the Netherlands
- ❑ Gerrit Uitbeijerse, Maersk Line, Western Operations Center, Rotterdam, The Netherlands
- ❑ Peter Wakefield, Gary Whittington, Wakefield Inspection Services (W.I.S.), Liverpool, United Kingdom
- ❑ Bruno Widmer, Global Business Manager, Cotton, Wool, Silk & Fibres Agricultural Services, SGS, Geneva, Switzerland
- ❑ Hans-Günter Wiesenack, Managing Director, Structured Trade & Commodity Finance, BHF-BANK, Frankfurt, Germany

Chapter 4: Cotton trading

- ❑ John Baffes, Senior Economist, The World Bank, Washington, DC, USA
- ❑ Kevin Brinkley, Vice President, Marketing & Business Development, The Seam, Memphis, TN, USA
- ❑ Ted Davis, former Managing Director, Corporate Communications, and Tim Barry, ICE Futures U.S., Inc. (formerly the New York Board of Trade – NYBOT), New York, NY, USA
- ❑ Paul J. Fisher, Commodity Specialist, trader and author, New York, USA
- ❑ William Griffin, Program Director, International Cotton Institute, Memphis, TN, USA
- ❑ Ambassador Burton Levin, Noble Cotton, Shanghai, China
- ❑ Philip Stern, Weil Brothers and Stern Ltd, Liverpool, United Kingdom
- ❑ Frédéric Viel, Bill Ballenden, Louis Dreyfus Commodities Suisse SA, Geneva, Switzerland

Chapter 5: Market segments

- ❑ Helen Chen, Esquel, Hong Kong, China, Beijing Office
- ❑ Common Fund for Commodities (CFC), Amsterdam, The Netherlands
- ❑ International Cotton Advisory Committee (ICAC), Washington, District of Columbia, USA
- ❑ Alex Kasterine, Senior Trade Development Adviser on Organics, International Trade Centre UNCTAD/WTO (ITC), Geneva

- ❑ Marc A. Lewkowitz, Executive Vice President, Supima, Phoenix, AZ, USA
- ❑ Andrew MacDonald, President, Brazil Cotton Association, São Paulo, Brazil
- ❑ Rabobank, Utrecht, The Netherlands
- ❑ Peter Ton, Organic Cotton Consultant, Amsterdam, The Netherlands

Chapter 6: Market profiles

- ❑ Aftab Ahmad, Aftab Associates (Pvt) Ltd, Pakistan
- ❑ Sebahattin Gazanfer, former General Manager, Taris, Izmir, Turkey
- ❑ Vivek Joshi, former Director and now Joint Secretary, Ministry of Textiles, Government of India
- ❑ Nurlaila Nur Muhammad, Commercial Attaché, Permanent Mission of Indonesia, Geneva, Switzerland
- ❑ A.S.M. Quasem, Chairman, Newage Group, Dhaka, Bangladesh
- ❑ Chanchai Sirikasemlert, Director, Technology Promotion Department, Thailand Textile Institute, Bangkok, Thailand
- ❑ Sun Juan, General Manager, China National Cotton Exchange International Trade Co. Ltd, Beijing, China
- ❑ Virat Tандаechanurat, Executive Director, Thailand Textile Institute, Bangkok, Thailand
- ❑ M.N. Vijayshankar, Vice President, PT Apac Inti Corpora, Semarang, Indonesia
- ❑ Lauren Wilson, China Liaison Officer, Queensland Cotton, Shanghai, China

Appendices

- ❑ Bremer Baumwollbörse (Bremen Cotton Exchange), Bremen, Germany
- ❑ Committee for International Co-operation between Cotton Associations (CICCA)
- ❑ Common Fund for Commodities (CFC), Amsterdam, The Netherlands
- ❑ Cotlook Limited, Liverpool, United Kingdom
- ❑ International Cotton Advisory Committee (ICAC), Washington, District of Columbia, USA

At ITC, Daniel Torres, Consultant, Market Development Section, provided managerial inputs. Alison Southby edited the guide, Kathryn Della Corte provided administrative support, and Isabel Droste and Carmelita Endaya prepared the copy for printing.

Contents

Foreword	iv–v
Acknowledgements	vii
Note	xxv

Introduction **1**

Chapter 1

The world cotton market **3**

Overview	3
Production	4
Production trends	5
Africa in perspective	6
Trends in mill use of fibre	7
Expansion of retail cotton use	8
Retail cotton consumption	8
Mill consumption	9
Inter-fibre competition	10
Long-term projections for textile fibre consumption	11
Trade	11
Biotech cotton in world textile trade	14
Government measures	14
The importance of cotton in world trade	16
Cotton prices	17
Cotton prices measured at many levels	17
Influence of time on prices	18
Spot sales and purchases	18
Forward cash sales and purchases	18
On-call sales and purchases	18
Marketing pools	19
Influence of location and quality on prices	19
Cotton and competing crop prices	20
Structural changes leading to lower real world cotton prices	21
Technology	22
Polyester	22
Prices of cotton yarn	23
Retail prices for clothes	24

Futures markets	24
Relationship between New York futures and the Cotlook A Index	25
Modeling cotton prices	25
Sources of price forecast error	26
Expectations of accuracy	27
The Cotlook Indices	27
A brief description	27
Daily quotations	28
The Cotlook A Index	29
Transition to an Asian (Far Eastern) basis	29
The dual system	30
Uses of the Cotlook Indices	30
Cotton in the Doha Development Agenda	31

Chapter 2

Cotton value addition 35

Impact of varieties and production practices on cotton quality	35
Varieties	35
Harvesting	35
Seed cotton storage and handling	36
Cotton ginning machinery	37
Seed cotton unloading	38
Feed control	38
Drying	38
Seed cotton cleaning	39
Gin stands	39
Roller-type gins	40
Lint cleaners	40
Moisture restoration	41
Packaging lint cotton	41
Effect of gin machinery on cotton quality	41
The impact of cotton fibre properties on textile processing performance, quality and costs	42
Micronaire	46
Maturity	47
Fineness	48
Length and length uniformity	48
Strength	49
Elongation	49
Colour	50
Preparation	50
Neps	50
Trash (non-lint) content	51
Wax content	51
Friction	51
Ultra-violet fluorescence	52
Dyeability	52
Stickiness	52
Crimp and bulk	52
Stiffness, elasticity, modulus and work-to-break	53
Neps and short fibres	53
Nature of neps and short fibres	53
Neps	53
Short fibres	54

Measurement of neps and short fibres	55
The AFIS® instrument	56
Other instruments for raw cotton	56
Conclusion	56
Extraneous contamination in cotton	57
What is the acceptable contamination level for the end-user of yarn and cloth?	57
Steps towards minimizing contamination	57
Manual contaminant cleaning at PT Apac, Indonesia	58
What proportions of bales from different origins are contaminated?	59
Fibrous and non-fibrous extraneous contamination in cotton bales	64
Electronic gadgets in the spinning process for removal of contamination	65
Blow room	65
Winding	65
Effect of the initial level of fibrous contamination in bales on residual level in yarn	65
Best solution: Solve the contamination problem at the origin	65
Conclusion	66
Classing and grading	66
Cotton classification	66
Manual grading of cotton	67
Grade standards	67
Cotton colour and colour grades	68
Cotton trash and leaf grades	69
Preparation	69
Extraneous matter	70
Use of instrumentation in cotton classification	70
Instrument standards	70
Establishing values for calibration cotton	70
Calibration of instruments	71
Laboratory conditioning	71
Sample conditioning	71
Instrument verification procedures	72
Fibre length	72
Length uniformity index	73
Fibre strength	73
Micronaire	74
Instrument colour	74
Trash	75
Harmonization of rapid machine testing of fibre quality	76
Understanding HVI and how to make it serve a global market	76
Implications for national HVI systems	79
Conclusion	80
Cotton bale packaging	80
Dimensions and density	81
Bale strapping or banding materials	82
Bale cover materials	83
Labelling	84
Textile processing	84
Yarn formation	84
Opening	85
Blending	85
Cleaning	85
Carding	85
Drawing	85
Lap preparation	86

Combing	86
Roving	86
Spinning	87
Fabric formation	89
Woven fabric	89
Knitted fabric	90
Nonwovens	91

Chapter 3

Cotton marketing 92

Contracts	92
The essential value of a well written contract	92
Variations and amendments to the contract	93
In the event of disputes	93
Appointment of an agent	93
Standard contractual terms	94
Quality – terms of valuation	94
Growth and quality	95
Quantity	96
Price and terms	96
Weight basis	96
Payment	97
Shipment	99
Freight – shipments by vessel	100
Insurance	100
Special clauses	101
Reverse side of the contract ‘conditions’	101
Main trade (logistical) terms and parties’ obligations	101
Documentation	102
Claims	104
Scope and validity of an offer or bid	104
Arbitration	105
General principles and aims of arbitration	105
Disputes addressed by ICA arbitration	106
Physical or mechanical tested characteristics of the cotton fibre	106
Technical arbitration – dealing with the written aspects of the contract	106
The commencement of arbitration and formalities	106
Appointment of arbitrators	107
Conducting the arbitration	107
The arbitration award	107
Appeal against an arbitration award	108
Failure to comply with an award	109
Promotion of good trading practice	109
The European Cotton Rules	109
Documentation (‘back office’)	110
Letters of credit	110
Payment: credit policy	110
Shipping advice	111
Delayed shipments	111
The bill of lading	112
Title to and endorsement of a bill of lading	113
Dispatching bills of lading	113
Certificates of origin	114

Insurance certificates	114
Other certificates	114
Missing and incorrect documents	114
Electronic paperwork	115
Paperwork – what paperwork?	115
Why do we need this amount of paper?	115
How can electronic paperwork assist me?	116
The electronic revolution	117
How secure is electronic paperwork?	118
Logistics	122
Freight	122
Shipping	122
Shipping in containers	125
Ocean freight rates	126
Controlling	128
Pre-shipment	130
Supervision of loading	130
Post-landed	130
Warehouse inspections	130
Who appoints the controller?	130
Pre-shipment	130
Post-landed	131
ICA Rules and Bylaws	131
Other pre-shipment services	132
Post-landed weighing	132
Bale by bale weighing	132
Weighbridge weighing	133
Taring	133
Arbitration sampling, micronaire sampling and sampling for strength	134
Arbitration sampling	135
Micronaire sampling	135
Sampling for strength	136
Moisture sampling	138
General	138
Surveying	139
The role of banks in cotton export finance	140
Transactional finance	141
Principal credit standards	141
Mitigation of the buyer's payment risk	141
Advance payments or export pre-finance	143
Advance payment guarantee	143
Red clause letter of credit	143
Warehouse receipt systems	144
What are warehouse receipt systems?	144
Unregulated warehouse receipt systems	145
Transaction cycle under an unregulated WRS for cotton	145
The regulated warehouse receipt system	146
Insurance in an uncertain world	149
Risk	149
Indemnity	150
Utmost good faith	150
Types of insurance cover to protect your business	150
Insurance through the stages of the cotton production process	150
Exclusions	152
When do I become liable? The attachment and termination of risk	152

Other important considerations	152
The importance of cover – claims	152
Available structures for your insurance cover	153
Glossary of basic insurance definitions	153
Risk management – A cotton supply chain manager’s perspective	154
Risk	154
Risk management framework	154
Risk governance	155
Governance structure	155
External assurance	155
Internal assurance	156
Segregation of duties	156
Risk measurement	156
Price charts – Cotlook A Index and New York Cotton Futures	157
Stress testing	158
Back testing	158
Counterparty risk	159
Operational risk – mapping	159
Risk culture	159
Cotton promotion	160
The importance of cotton promotion	160
Producing countries, trading countries, and consuming countries	160
International, national, state and private sector promotion programmes	161
Generic and branded cotton promotion	161
Demand enhancement vs. promotion	162
Export focused promotion and domestic promotion	163
The cost of cotton promotion	164
High cost promotion activities	164
Medium cost promotion activities	164
Low cost promotion activities	164
Promotion strategy	165
Factors that can affect promotion	165
Annex – ICA model contract	167

Chapter 4

Cotton trading	169
The role of merchants in cotton exports	169
The changing role of cotton merchants	173
Cotton exports and Internet trading	174
Cotton exports and Internet auctions: a case study	175
Internet auctions	175
Facilitating the auction market	175
Strategies and effects	176
The future	177
Conclusion	177
Cotton futures and options – ICE Futures U.S.	177
Two markets	178
Price risk	179
Price quality	180
Leverage	180

Organization of a futures market	181
Clearing house	181
Trading	181
Supervision and regulation	182
The former NYBOT and now ICE Futures U.S. cotton marketplace	182
Cotton forward contracts	182
Futures and options contracts	183
The fundamentals of cotton supply and demand	186
Electronic trading of futures contracts	188
Other futures markets	189
Brazil	189
The recent cotton contract	189
China	190
The Zhengzhou Commodity Exchange	190
India	191
The recent cotton contract	191
Trading in futures	193
Overview	193
Floor procedure	193
Delivery	193
Offsetting transactions	193
Futures prices	194
Differences between forward and futures market prices	194
Types of orders	195
Positions	195
Margins	196
Financing margins	196
Technical analysis of futures markets	196
Open interest and volume of operations	197
Volume of operations	198
Relationship between open interest, volume and price	198
Charting	199
Hedging and market systems	200
Risk considerations	200
Price risk	200
Basis risk	201
Counterparty risk	201
Currency risk	201
Financial risk	201
Government risk	201
Hedging with futures contracts	201
Hedging with options	204
Call options	204
Put options	204
Using options	204
Guaranteed minimum price contract	204
Guaranteed maximum price contract	205
Trading physicals at a price to be fixed	206
Guaranteed minimum price contracts	207
The purpose of the guaranteed minimum price contract	207
When to use the guaranteed minimum price contract	207
The advantages of the guaranteed minimum price contract	208
The disadvantages of the guaranteed minimum price contract	208
The workings of a guaranteed minimum price contract	208
How to value insurance premium	208
A practical example	209
Conclusion	209

Chapter 5

Market segments	210
Types of cotton	210
Price differentials	211
Conventional cotton	211
Organic cotton	212
Biotech cotton	212
Coloured cotton	213
Extra long staple cotton	214
ELS cotton production	215
ELS cotton exports	215
ELS cotton consumption	216
American ELS Competitiveness Payment Program	216
ELS cotton flourishes in niche markets	216
Organic cotton: an opportunity for trade	217
Organic cotton	217
Standards	218
Requirements for processing	218
'Fair trade' cotton	219
Standards	220
Development of fair trade cotton	220
Organic and fair trade	221
The organic cotton market	221
The history of organic cotton production	221
Trends in the 1990s	221
Trends between 2000 and 2005	222
Organic cotton production	223
Organic cotton consumption	225
Organic cotton: an issue of large brands?	227
Organic cotton processing	227
Retail of organic cotton items	228
Pricing and positioning	229
'Fair' pricing	230
Geographical markets and large brands	230
United States of America	231
Switzerland	232
Germany	232
United Kingdom	233
France	234
Other markets	235
Future development of the organic cotton market	235
Arguments in favour of expanding organic cotton	235
Arguments against expanding organic cotton	236
Opportunities	238
Threats	240
Conclusions	241
Organic cotton production	241
Organic cotton processing	242
Retail of organic cotton items	242
Infrastructure of the organic cotton market	243
Opportunities for cotton ginner and exporters	243

Chapter 6

Market profiles	245
Bangladesh	245
The structure and characteristics of the domestic cotton market	245
Future market developments – demand and supply forecasts	245
Supply and demand in the national market	245
Yarn supply situation and future demand	246
What kind of cotton is supplied from abroad, and from which countries?	246
Imports of cotton into Bangladesh	247
Development of imports in the last five years	247
Prices	248
Cotton qualities supplied domestically	248
Specific cotton quality requirements of the domestic textile industry	249
Cotton import procedures in Bangladesh	249
Recommendations for LDC cotton exporters on increasing exports to Bangladesh	250
China	251
The structure and characteristics of the domestic cotton market: a macro view	251
Importance of cotton in Chinese textiles	251
Domestic cotton	251
Domestic cotton market	252
Quality of cotton produced and imported	253
Supply and demand in the national market	253
Specific cotton quality requirements of the domestic textile industry	253
Import developments	254
Quota system and management of China's cotton industry	255
Non-tariff requirements in the domestic market	257
Customs procedures	257
Freight forwarding and transport requirements	258
Packaging, marketing, labelling and specific domestic business practices	258
Expected market developments	260
The domestic market: a micro view	260
Different players in the market	260
Specific cotton contracts	260
Cotton finance and payment regulations	261
Use of e-commerce and ICT for procurement	261
Consumer preference for specific fibre types and blending	261
Shandong Weiqiao Pioneering Group: case study of a large national cotton consumer	261
Possible niche markets and product groups to be targeted	262
Recommendations for LDC cotton exporters for penetrating the Chinese market	262
Detailed rules for quota management of cotton imports in China	263
Chronology of policies and events related to China's cotton import quota	264
India	266
The structure and characteristics of the domestic cotton market	266
Importance of cotton in Indian textiles	266
National cotton production	266
The domestic cotton market	267
Quality of cotton supplied by the domestic industry, and imports	267
Supply and demand in the national market	268
Specific cotton quality requirements of the domestic textile industry	268
Analysis of import tariff structure	269
Non-tariff requirements in the domestic market	269
Cotton import procedure	269
Special import regulations	269

Customs procedures	269
Freight forwarding and transport requirements	270
Packaging, marketing, labelling and specific domestic business practices	270
Expected market developments	270
The domestic market: a micro view	270
Different players in the market	270
Specific cotton contracts used in the market	271
Cotton finance and payment regulations	271
Use of e-commerce and ICT for procurement	272
Consumer preference for specific fibre types and blending	272
Large national cotton consumers	272
Possible niche markets and product groups to be targeted	272
Existing national support schemes	273
Recommendations for LDC cotton exporters on increasing exports to India	273
Indonesia	274
The Indonesian textile industry: a macro view	274
Supply and demand in the national market	274
Domestic cotton production	274
The Indonesian spinning sector	274
Future demand	275
Imports of cotton into Indonesia	275
Cotton import procedures in Indonesia	276
Selling practices	277
Recommendations for LDC cotton exporters on increasing exports to Indonesia	277
Pakistan	279
The structure and characteristics of the domestic cotton market	279
The importance of cotton in Pakistan's economy	279
National production	280
Market size and prices	280
Cotton qualities supplied by the domestic industry and from abroad	281
Supply and demand in the national market	282
An analysis of the tariff structure of imports	282
Non-tariff requirements in the domestic market	283
Customs procedures	283
Specific domestic business practice	284
Expected market developments	284
The domestic market: a micro view	284
The players in the market	284
Cotton procurement practices	285
Specific cotton contracts used in the market	285
Cotton finance and payment requirements	285
Consumer preferences for specific fibre types and blending	285
Preferences of large national cotton consumers	285
Local spinners' recommendations on how best to penetrate the domestic market	286
Organic cotton	286
Recommendations for LDC cotton exporters on increasing exports to Pakistan	286
Thailand	287
The structure and characteristic of the Thai cotton market: a macro view	287
Importance of cotton in Thailand	287
Domestic cotton production	287
Government encouragement	288
Domestic pricing structure	288
Import structure	288

Tariff and non-tariff requirements in the domestic market	290
Taxation	290
Cotton import requirements	290
Actual import procedure	291
Expected market developments	292
Case studies of large national cotton consumers	292
In-depth interviews on penetrating the Thai cotton market	293
Company A	293
Company B	294
Company C	295
Turkey	295
The structure and characteristics of the domestic cotton market: a macro view	296
Market size and prices	296
Cotton qualities supplied by the domestic industry	297
National production	299
Specific cotton quality requirements of the domestic textile industry	299
Analysis of the tariff structure of imports	299
Non-tariff requirements in the domestic cotton market	299
Expected market developments: demand and supply forecasts and future market prospects	300
The domestic market: a micro view	300
Different players in the market	300
Cotton procurement practices in the market	302
Specific cotton contracts used in the market	302
Cotton finance and payment regulations	302
Consumer preferences for specific fibre types and blending	303
Case studies of large national cotton consumers	303
Company 1: Beyteks	303
Company 2: Menderes Tekstil A.Ş.	304
Company 3: Iskur A.Ş.	305
Company 4: Kipaş Holding	306
Possible niche markets and product groups to be targeted	307
Existing national support schemes that could be utilized to assist cotton-exporting LDCs to penetrate the Turkish market	307
Recommendations to LDC cotton exporters for promoting exports to Turkey	307
Cotton classification parameters in Turkey	308
Annex – Useful addresses	311

Appendices

I. International cotton associations	323
II. Conversion factors	328
III. Useful websites	331

Tables

1.1 Share of cotton in product exports from selected African countries	16
2.1 Order of importance of fibre properties for different spinning systems	45
2.2 Extraneous contamination by origin (2006–2007 averages) as experienced by PT Apac Inti Corpora, Indonesia	59
2.3 Official grades of American Upland cotton	68
2.4 Upland instrument length to staple length conversion chart	72
2.5 Interpreting the degree of fibre uniformity from LUI	73
2.6 Interpretation of fibre strength levels	73
2.7 Dimensions and density of the ISO-compliant bales	81

5.1	Organic cotton production and trade worldwide	224
5.2	Consumption of organic cotton fibre by main textile and clothing companies	226
6.1	Cotton consumption and import volumes in China, 2002–2006	254
6.2	Effects of sliding-rate tariff	256
6.3	Cotton import quota issued and used, 2000–2006	257
6.4	Indonesian cotton imports, by country of origin, 2002–2006	276
6.5	Textile industry projections for Pakistan for 2010	279
6.6	Supply and consumption of Pakistan cotton	287
6.7	Quantity and value of imported cotton in Thailand, 2002–2006	288
6.8	Quantity and value of imported cotton in Thailand, by category from top five countries, 2004–2006	289
6.9	Quantity and value of cotton exported from Thailand, 2002–2006	289
6.10	Quantity and value of cotton yarn exported from Thailand, 2001–2005	290
6.11	Quantities and origins of cotton imported by Turkey, 1996–2006	298
6.12	Cotton demand and supply projections for Turkey	301
6.13	Colour grades (based on HVI definitions) and trash content of domestic cottons	309
6.14	HVI test results for cottons from various locations in Turkey	309

Figures

1.1	World cotton production	4
1.2	World cotton cultivation area	4
1.3	World yields	5
1.4	Cotton production, 1983-2005	5
1.5	Cotton production, 2006/07	5
1.6	Cotton yields	6
1.7	African cotton exports	7
1.8	World fibre use	7
1.9	Cotton end-use	8
1.10	World mill use	9
1.11	Cotton mill use, 2006/07	10
1.12	World fibre use: cotton vs non-cotton	10
1.13	Cotton market share	11
1.14	World exports	11
1.15	Cotton exports, 2006/07	12
1.16	World cotton imports, 1980/81-2005/06	12
1.17	Cotton imports, 2006/07	13
1.18	World biotech cotton area	14
1.19	Direct government assistance to cotton	14
1.20	Average direct assistance	15
1.21	Cotton prices: Cotton Outlook quotes in US cents per pound	20
1.22	Cotton prices – Ratio: US Pima to the Cotlook A Index	20
1.23	Cotton and wheat prices	21
1.24	Cotton and maize prices	21
1.25	Cotton and soybean prices	21
1.26	Deflated Cotlook A Index: 2004 US cents per pound	21
1.27	Cotlook A Index: Season-averages in US cents per pound	21
1.28	Fibre prices	23
1.29	Cotton and yarn prices	24
1.30	Cotton prices: Cotlook A Index and NY Nearby Futures	25
1.31	Net imports by China and international cotton prices	26
1.32	Cotlook A Index: Cents per pound, model forecast using current data	26
1.33	Cotlook A Index, 1996–2007	28
1.34	Dual index system	30

2.1	Typical spindle-type mechanical harvester for cotton	36
2.2	Typical stripper harvester for cotton	36
2.3	Typical free-standing modules of seed cotton	36
2.4	Spindle picker dumping into a module builder	36
2.5	Minimum machine sequence used to process clean, hand-picked cotton	37
2.6	Representative cross-sections of typical types of gin machinery arrayed in a sequence used for spindle-picked cotton	38
2.7	Continental Eagle 161 Golden Eagle Saw brush-type gin stand	40
2.8	Typical saw-type lint cleaner	40
2.9	Moisture content during gin processing is a compromise between cleaning efficiency and fibre quality	42
2.10	The effect of cotton fibre properties on rotor-spun yarn strength	43
2.11	The effect of cotton fibre properties on ring-spun yarn strength	43
2.12	Average price contribution of quality attributes, 1993–1998	43
2.13	Cross-sections of cotton fibres differing in maturity	47
2.14	Fibrous neps and seed coat neps	50
2.15	A nep in raw cotton	53
2.16	A nep in yarn	54
2.17	A seedcoat nep in yarn	54
2.18	White speck nep (highly magnified) attached to mature fibre	54
2.19	Length distribution (by weight) of two cottons with similar staple length	55
2.20	General view of manual cleaning line	58
2.21	Cleaning table with wire mesh and white top	58
2.22	Contamination collected in waste bags	58
2.23	Cleaned cotton on the conveyer	58
2.24	UV checking	59
2.25	Repacked bales	59
2.26	Some typical common contaminants found in manual cleaning	60
2.27	HVI colour chart for American Upland cotton	75
2.28	HVI colour chart for American Pima cotton	75
2.29	Sectors encompassed in a harmonized HVI system	77
2.30	Banded bale	82
2.31	A bale plucker	85
2.32	Diagram of a card	86
2.33	Diagram of drawing sliver	86
2.34	Diagram of a roving operation	86
2.35	Diagram of a ring spinning operation	87
2.36	Ring spun yarn	87
2.37	Diagram of an open end (rotor) spinning operation	88
2.38	Open end (rotor) yarn	88
2.39	Air jet (vortex) spinning	88
2.40	Air jet (vortex) spun yarn	88
2.41	Diagram of a weaving loom	89
2.42	Woven fabric (plain weave pattern)	89
2.43	Basic weave patterns	89
2.44	Circular weft knitting	90
2.45	Diagram of knitted fabric	90
2.46	SEM of knitted fabric	90
2.47	SEM of a thermal bonded nonwoven fabric	91
2.48	SEM of a hydroentangled nonwoven fabric	91
3.1	Payment flow	142
3.2	Key players in the unregulated WRS	145
3.3	The process for effective risk management	149
3.4	Insurance options	151
3.5	Typical supply chain for cotton	151
3.6	Risk framework	155

3.7	Governance structure	155
3.8	Segregation of duties	156
3.9	Price chart	157
3.10	Risk control system	160
3.11	Push and pull strategies	165
4.1	The Cotlook A Index	172
4.2	The Seam's Bid Manager allows buyers to participate in auctions unattended, by establishing their price parameters and then letting the system bid for them	176
4.3	Buyers can view auction activity and respond to price changes	176
4.4	Yearly high and low prices	200
4.5	Cotlook A Index vs futures	201
4.6	New York vs Cotlook A Index	207
5.1	Comparison of lengths of Upland and ELS cottons	214
5.2	Comparison of strength of Upland and ELS cottons	214
5.3	Organic cotton production and trade worldwide	225
5.4	Organic cotton production and trade per production area	225
6.1	Yearly cotton consumption in China, 1980–2006	251
6.2	Trends in China's cotton area and yield (1995–2006)	252
6.3	Annual average prices of raw cotton (China Cotton Index)	252
6.4	Chinese imports of raw cotton by country, 2006	253
6.5	Imports of raw cotton, 1996–2006	254
6.6	Changes in China's imports and exports of cotton, 1980–2006	255
6.7	Comparison between CC Index and Cotlook A, 2002–2007	257
6.8	Cotton linter and cotton waste imports, 2004–2006	262
6.9	Cotton balance sheet	267
6.10	Area, production and productivity of cotton	267
6.11	Annual average prices of seed cotton	267
6.12	Annual average prices of lint cotton	267
6.13	Imports of raw cotton	268
6.14	Imports of raw cotton by country (2004/05)	268
6.15	Pakistan cotton area, production and yield	280
6.16	Seed cotton market prices – seasonal averages	281
6.17	KCA spot rates for lint cotton at Karachi by variety – seasonal averages	281
6.18	Raw cotton imports, by origin, 2005/06 (up to April)	282
6.19	Imports of raw cotton, 2000/01 to 2005/06	282
6.20	Production and consumption of cotton in Thailand	287
6.21	Planted area and production of cotton	288
6.22	Annual average price of cotton	288
6.23	Quantity and value of imported cotton from top five countries, 2006	289
6.24	Imports of cotton by country, 2006	289
6.25	Quantity of exported cotton yarn	290
6.26	Marketing channels for seed and lint cotton in Turkey	297
6.27	Comparison of Std. 1 Aegean cotton domestic prices with the Cotlook A Index, 1 September – 31 August 2006	297
6.28	Cotton supply in Turkey (actual)	300

Note

Unless otherwise specified, all references to dollars (\$) and cents are to United States dollars and cents. All references to tons are to metric tons. The term 'billion' denotes 1 thousand million.

The following abbreviations are used:

AFIS	Advanced Fibre Information System
APTMA	All Pakistan Textile Mills Association
ASCU	Agricultural Sales Cooperative Union (Turkey)
ASTM	American Society for Testing and Materials International
B/L	Bill of lading
BM&F	Bolsa de Mercadorias e Futuros (Brazil)
BTMA	Bangladesh Textile Mills Association
CCI	Cotton Corporation of India
CDB	Cotton Development Board (Bangladesh)
CFA	Communauté financière africaine
CFR	Cost and freight
CFS	Container freight station
CFTC	Commodity Futures Trading Commission (United States)
CICCA	Committee for International Co-operation between Cotton Associations
CIF	Cost, insurance and freight
CIQ	China Entry-Exit Inspection and Quarantine
CIS	Commonwealth of Independent States
CL	Confidence level
CMA	Collateral management agreement
CNCE	China National Cotton Exchange
CNCRC	China National Cotton Reserves Corporation
CNY	Chinese yuan
COT	Commitment of traders
CSCE	Coffee, Sugar and Cocoa Exchange
CSR	Corporate social responsibility
CV	Coefficient of variance
CY	Container yard
DDA	Doha Development Agenda
DFQF	Duty-free quota-free
ECR	European Cotton Rules
EDI	Electronic data interchange
EFP	Exchange of futures for physicals
EFS	Exchange for swaps
EICA	East India Cotton Association
ELS	Extra long staple
EU	European Union
EUR	Euros
EWR	Electronic Warehouse Receipt
FAS	Free alongside ship
FCA	Free carrier
FCFA	Franc communauté financière africaine
FCL	Full container load

FLO	Fairtrade Labelling Organizations International
FOB	Free on board
FOT	Free on truck
FTZ	Free trade zone
GAP	South-east Anatolian Project (Turkey)
GBP	United Kingdom pounds
GDP	Gross domestic product
GM	Genetically modified
GOTS	Global Organic Textile Standards
GSP	Generalized System of Preferences
H&M	Hennes & Mauritz
HPLC	High-performance liquid chromatography
HS	Harmonized System
HVI	High Volume Instrument
ICA	International Cotton Association
ICAC	International Cotton Advisory Committee
ICE	IntercontinentalExchange
ICM	Integrated crop management
ICT	Information and communication technology
IDR	Indonesian rupiahs
IFCP	International Forum for Cotton Promotion
IFOAM	International Federation of Organic Agriculture Movements
IIC	International Institute for Cotton
IME	Izmir Mercantile Exchange
IMO	International Maritime Organization
IPM	Integrated pest management
ISO	International Organization for Standardization
ITMF	International Textile Manufacturers Federation
IVN	Internationaler Verband der Naturtextilwirtschaft (Germany)
JAS	Japan Agricultural Standard
JOCA	Japan Organic Cotton Association
L/C	Letter of credit
LCL	Less than container load
LDC	Least developed country
LS	Long staple
LUI	Length uniformity index
MFN	Most-favoured nation
ML	Mean length
M&S	Marks & Spencer
MMF	Man-made fibre
NCDEX	National Commodity and Derivatives Exchange (India)
NGO	Non-governmental organization
NIR	Near infra-red
NOP	National Organic Program (United States)
NYBOT	New York Board of Trade
NYCC	New York Clearing Corporation
NYCE	New York Cotton Exchange
OE	Open-end
OFS	Options on futures spreads
OTA	Organic Trade Association (United States)
PTBF	Price to be fixed
PTS	Primary textile sector
RMG	Ready-made garments
SDPC	State Development and Planning Commission (China)
SDRC	State Development and Reform Commission (China)
SEM	Scanning electron microscope
SFC	Short fibre content

SG	Saw-ginned
SITC	Standard Instrument Testing
SLM	Strict low middling
SMEs	Small and medium-sized enterprises
TEU	20-foot equivalent unit
THC	Terminal handling charges
UCP	Uniform Customs and Practice for Documentary Credits
UHML	Upper half mean length
UNCTAD	United Nations Conference on Trade and Development
USDA	United States Department of Agriculture
USDA/AMS	United States Department of Agriculture, Agricultural Marketing Service
UV	Ultra-violet
VAT	Value added tax
VSA	Vessel sharing arrangements
WR	Warehouse receipt
WRS	Warehouse receipts system
WTO	World Trade Organization
ZCE	Zhengzhou Commodity Exchange (China)

Introduction

Cotton is an important commodity in the world economy, accounting for trade worth approximately \$12 billion in the marketing year 2005/06 (August–July).

The guide is based on contributions of renowned professionals from all continents, including international organizations, government authorities, universities, international trading houses, cotton service providers and cotton importing textiles industries.

The *Cotton Exporter's Guide* covers all the essential components of the cotton trade. Its ambition is to meet the needs of today's exporters who face many challenges – commercial, technical, logistical, environmental and social – in an increasingly sophisticated and competitive trading environment.

The *Cotton Exporter's Guide* is divided into six chapters. Chapter 1 provides an overview of the world cotton market (production, consumption and trade), factors influencing supply and demand, market trends, cotton pricing and Cotlook Indexes, and major issues of the sector, including trade policy and WTO.

Chapter 2 assesses cotton demand, with sections on textile processing of cotton, physical characteristics of cotton, cotton quality and its determinants, neps and short fibres, the issue of contamination, classing and grading, instrument testing.

Chapter 3 looks at cotton trading, with sections on packaging, controlling, back office and documentation, freight and shipping, financing, warehouse receipts, insurance, risk management, contracts and arbitration.

Chapter 4 focuses on cotton marketing and promotion, with sections on e-commerce (Internet auction and electronic paperwork), the New York Board of Trade and the other futures markets, hedging and marketing, the minimum guaranteed price system, the role of merchants in cotton exports and cotton promotion.

Chapter 5 reviews the market segments with sections on the different types of cotton, conventional and biotech cottons and extra long staple cottons, and highlights the organic cotton market.

Chapter 6 presents market profiles of the main importing countries in Asia (Bangladesh, China, India, Indonesia, Pakistan, Thailand and Turkey), with recommendations on how to approach their booming cotton-consuming textile industries.

Finally appendices include in particular a detailed list of useful websites for additional information.

In line with section 12 of the WTO Hong Kong Ministerial Declaration, which urges 'Members to promote and support South-South cooperation, including transfer of technology', the *Cotton Exporter's Guide* addresses trade-related problems facing cotton producers and exporters in African and other developing countries, and will help in developing South-South trade linkages

between African cotton exporters and Asian cotton importers. The contributors and ITC share the belief that increased efficiency and better understanding of the trade will assist producers and exporters in their quest to maximize their export earnings.

The *Cotton Exporter's Guide* deals only with exports of cotton lint, not carded or combed, also referred to as 'raw cotton', exclusive of cotton waste, cotton linters, cotton carded or combed, cotton yarns, cotton fabrics, cotton seeds, cottonseed oil and cakes. In the worldwide system for classification of traded goods commonly referred to as the Harmonized System (HS), the Harmonized Tariff Schedule Code for cotton, not carded or combed, is 5201.00. This code corresponds to subgroup 263.1 in the United Nations Standard International Trade Classification (SITC – Revision 3).

Chapter 1

The world cotton market

Overview

Cotton and cotton textile industries are central to the economic growth of both developed and developing countries, and contribute to development that is sustainable and socially responsible. Cotton is the raw material of wealth, industrialization and development. It is a vital cash crop providing income for everything from education, health and housing to transportation, and often serves as a catalyst for industrialization and rising social welfare.

World cotton production and consumption are trending higher, and the industry is being transformed by new technologies, including biotechnology. World cotton production reached a record of 26 million tons in 2004/05, and production remained nearly as high in the two years following. Biotech cotton varieties accounted for over one-third of world area in 2006/07.

The average cost of cotton production varies widely across countries, but the cost of production for most producers is between US\$ 0.50 and US\$ 0.60 per pound. While per capita consumption of cotton at the retail level is highest in developed countries, the strongest growth in both retail consumption and mill use of cotton is occurring in developing countries, particularly China, India and Pakistan.

The elimination in January 2005 of quotas that limited trade in textiles and apparel for more than 30 years is leading to a shift in textile and apparel production toward China and other developing countries, and the cotton industry is benefiting from increased consumption caused by lower retail prices of textile and apparel products. However, substantial distortions caused by subsidies still exist in the market for cotton itself.

International cotton prices have declined in real terms over the last six decades because of advances in technology, and this process is continuing. During the 1970s, 1980s and 1990s, the average world price of cotton was more than US\$ 0.70 per pound, but the average international price during the current decade is expected to be between US\$ 0.50 and US\$ 0.60 per pound, in line with the costs of production for most producers.

Cotton is one of the most important and widely produced agricultural and industrial crops in the world. Cotton is grown in more than 100 countries, on about 2.5% of the world's arable land, making it one of the most significant crops in terms of land use after food grains and soybeans. Cotton is also a heavily traded agricultural commodity, with over 150 countries involved in exporting or importing cotton.

More than 100 million family units are engaged directly in cotton production. When family labour, hired farm labour and workers in ancillary services such as transportation, ginning, baling and storage are considered, total involvement in the cotton sector reaches an estimated 350 million people. It provides employment to additional millions in allied industries such as agricultural

inputs, machinery and equipment, cotton-seed crushing and textile manufacturing. Cotton cultivation contributes to food security and improved life expectancy in rural areas of developing countries in Africa, Asia and Latin America. Cotton played an important role in industrial development starting in the eighteenth century and continues to play an important role today in the developing world as a major source of revenue. The value of 25 million tons of world cotton production in 2006/07 at an average world price of about US\$ 0.58 per pound of lint, or US\$ 1.28 per kilogram, is more than US\$ 30 billion.

Production

The world cotton industry has experienced dramatic changes over the last five decades as production nearly quadrupled, rising from 6.6 million tons in 1950/51 to a record of 26.3 million tons in 2004/05 (see figure 1.1). The average rate of growth in world production over the last five decades has been about 2.5% per year, or about 280,000 tons per year. Growth in cotton production was steady during the 1950s and 1960s but slowed during the 1970s because of slower world economic growth and limited gains in cotton yields. World cotton production exploded from 14 million tons in the early 1980s to 19 million tons in 1984/85, as market incentives and the widespread use of better seed varieties and better methods of plant protection led to increased yields. World production climbed to a record of nearly 21 million tons in 1991/92 but levelled off during the 1990s. With the commercial application of biotech cotton varieties beginning in 1996 and the expansion of cotton areas in francophone Africa, Australia, central Brazil, western China, and Turkey, world production exceeded 26 million tons in 2004/05 and has remained nearly as high during the two seasons since.

Since 1950/51, the world area dedicated to cotton has fluctuated between 28 million hectares and 36 million hectares; the average has been 32.7 million hectares (see figure 1.2). While there have been dramatic reductions in cotton area in some regions since the 1950s, particularly in the United States, North Brazil and North Africa, there have been offsetting increases in francophone Africa, Australia, China, India, Pakistan and the Middle East. With total area showing no tendency to rise, all the growth in world cotton production since the 1940s has come from improved yields.

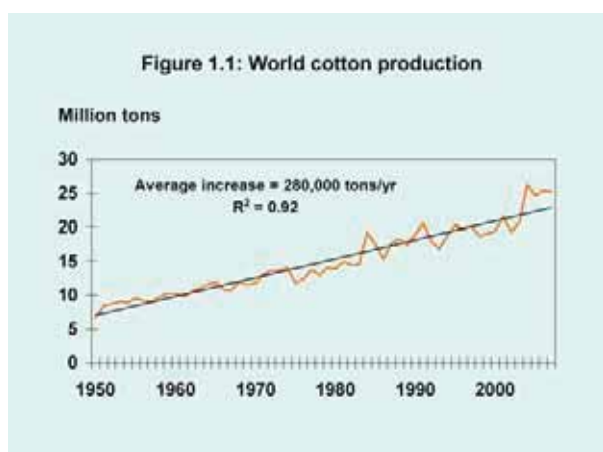

Source: ICAC.

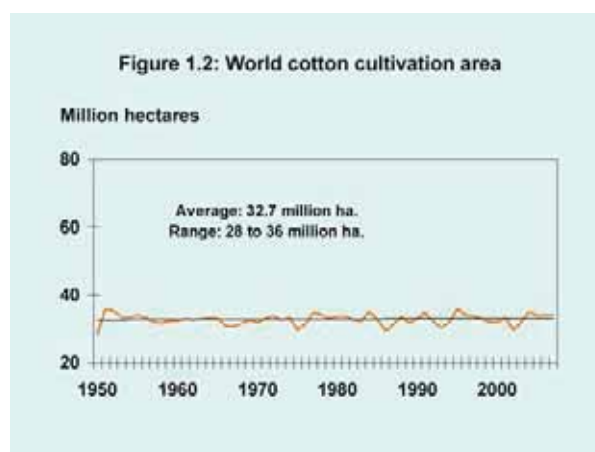

Source: ICAC.

The world cotton yield in the early 1950s was 230 kilograms of lint per hectare (see figure 1.3). Yields rose steadily at an average rate of more than 2% per year during the 1950s and 1960s, and then grew more slowly from the mid-1970s until the mid-1980s. During the 1980s the world cotton yield rose

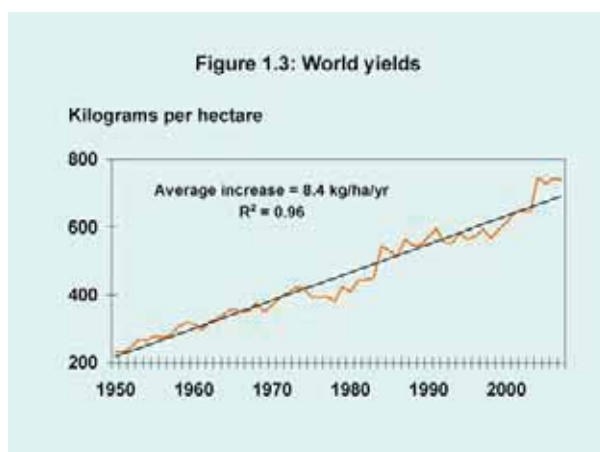

Source: ICAC.

dramatically, reaching a record of nearly 600 kilograms per hectare in 1991/92. However, yields stagnated during the 1990s due to problems associated with diseases, resistance to pesticides, and disruption of production for economic reasons. Yields began rising again in the late 1990s with improvements in seed varieties and the use of biotech varieties, and the world yield in 2004/05 reached a record 747 kilograms per hectare. The yield in 2006/07 is estimated at essentially the same level, and still well above the previous five-year average. The average rate of increase over the last six decades has been a little more than 8 kilograms per hectare per year.

Production trends

Cotton is produced in about a hundred countries, but production has traditionally concentrated in a few (see figure 1.4). Over the last three decades, the four leading producing countries have accounted for an increasing share of world production. China, the United States, India and Pakistan accounted for 48% of world production in 1970/71 and 72% in 2006/07. The share of industrialized countries (the United States, Australia, Spain and Greece) was little changed at 19% of world production in 1980/81 and 21% in 2006/07. Developing countries accounted for 61% of world production in 1980/81 and 72% in 2006/07. Cotton production in the former Soviet Union declined during the last two decades, accounting for 19% of world production in 1980/81 and 7% in 2006/07.

Production in China, the largest producer, increased at an average annual rate of 5% during the 1980s and fluctuated within a range of 3.7 to 5.7 million tons during the 1990s. Production in China rose to a record of 6.3 million tons in 2004/05 and is forecast to reach a new record of 6.7 million tons in 2006/07 (see figure 1.5).

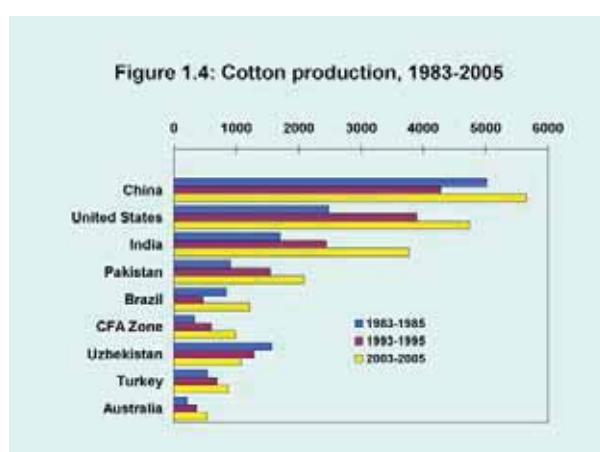

Source: ICAC.

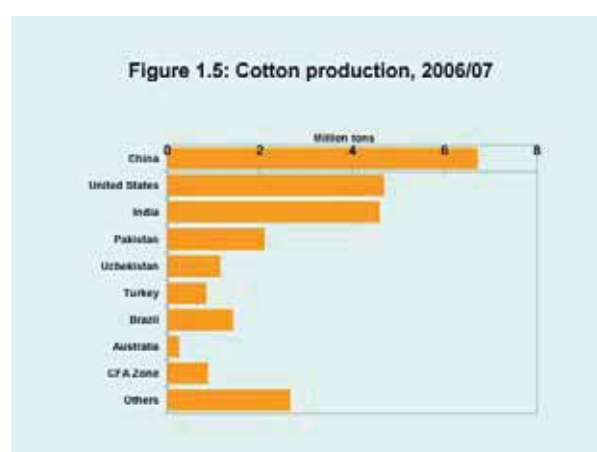

Source: ICAC.

In the United States, cotton production increased from 2.4 million tons in 1980/81 to 3.3 million tons in 1990/91, and fluctuated between 3 and 4.3 million tons during the 1990s before rising to 5.2 million in 2005/06. United States production was 4.7 million tons in 2006/07 because of reduced rain.

Cotton production in India rose from 1.3 million tons in 1980/81 to 3.0 million in 1996/97. Thereafter, production fell to 2.3 million tons in 2002/03 before reaching a record of 4.6 million tons in 2006/07. India has rapidly adopted biotech cotton varieties since 2002, and this seems to be contributing to rising yields.

Production in Pakistan expanded rapidly during the 1980s, growing from 700,000 tons in 1980/81 to 2.2 million tons in 1991/92. However, production fell in 1992/93 and remained below the 1991/92 level until 2004/05 when production rose to 2.5 million tons. Difficulties combating disease are again resulting in lower production, forecast at 2.1 million tons in 2006/07.

Cotton production in Brazil declined rapidly between the mid-1980s and the mid-1990s because of structural changes in favour of soybeans and because of infestation from the cotton boll weevil. Brazilian production recovered in the second half of the 1990s as production shifted to the centre of the country, where cotton had not previously been grown. Production, which declined from 965,000 tons in 1984/85 to 310,000 tons in 1996/97, climbed back to 940,000 tons in 2000/01 and to 1.3 million tons in 2004/05, surpassing Uzbekistan and Turkey. Production in 2006/07 is estimated at 1.4 million tons.

Cotton production in Turkey increased from 650,000 tons in 1990/91 to 850,000 tons in 2006/07. Cotton production in Australia increased very rapidly during the 1980s and 1990s, from 100,000 tons in 1980/81 to 800,000 tons in 2000/01. Because of drought, production was only 250,000 tons in 2006/07. Cotton production in the European Union (EU) increased from 300,000 tons in 1990/91 to 500,000 tons in 2004/05. A combination of weather and changes in cotton policies in the EU led to a reduction in output to an estimated 370,000 tons in 2006/07.

Africa in perspective

In Africa, cotton production increased from 1.3 million tons in 1990/91 to 1.8 million tons in 1997/98, but low cotton prices discouraged additional increases in African production in the following years. African production rose to 2 million tons in 2004/05 but fell to 1.6 million tons in 2006/07. Francophone countries in West and Central Africa produced 870,000 tons in 2006/07, accounting for 54% of production in the continent.

Cotton production in Africa as a whole rose by 3% per year from 1994/95 to 2005/06, after having been flat during the 1980s and early 1990s. The growth in African production coincided with a devaluation of the CFA franc. However, production has not grown in all countries. Production in North Africa has changed little since 1994/95, at 380,000 tons, while production in francophone Africa rose from 600,000 tons to 900,000 tons. Production in Southern and East Africa rose from 280,000 tons in 1994/95 to 460,000 tons in 2005/06.

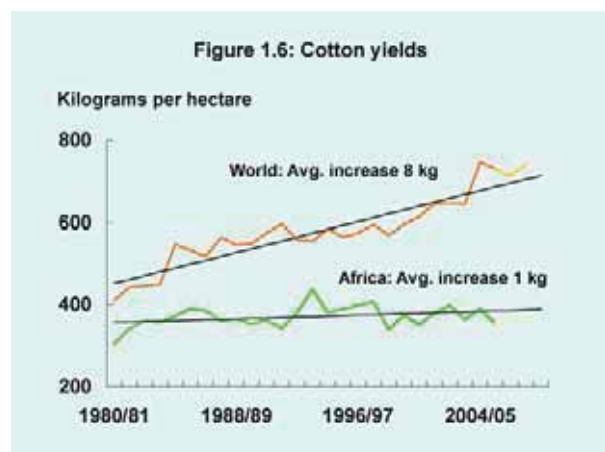

Source: ICAC.

However the expansion in African production came mostly from increases in area devoted to cotton, rather than rising yields (see figure 1.6). During the first three seasons of the 1980s, the average cotton yield across Africa was 336 kilograms per hectare, which equalled 78% of the world yield at that time of 433 kilograms per hectare. By the early 1990s, the average African yield had risen to 362 kilograms, but this was just 63% of the world yield. And, during the three most recent seasons, the average African cotton

yield was barely changed at 369 kilograms per hectare, just 52% of the world yield of 705 kilograms. There are a number of reasons why yields in Africa have not risen in tandem with the world yield, including lack of access to inputs, weak research and extension systems in many countries, and the fact that very little irrigation is used on cotton in Africa, while more than half of world production is irrigated.

African cotton area rose from a three-year average of 3.5 million hectares in the early 1980s, representing 10% of world area, to an average of 4.9 million hectares currently, accounting for 14% of world area. Cotton area in East and Southern Africa fell from 1.9 million hectares in the early 1980s to 1.1 million hectares during one year in 1993/94, before rising again to 2 million hectares currently. The area devoted to cotton in North Africa fell from 880,000 hectares during the early 1980s to about half that level currently, while cotton production in the francophone region showed impressive gains, rising from 670,000 hectares in the 1980s to 2.4 million hectares currently. The devaluation of the CFA franc in 1994 gave a boost to cotton production in francophone Africa.

African cotton exports climbed from about 600,000 tons in the early 1980s to an estimated 1.6 million tons currently (see figure 1.7). Exports from North Africa

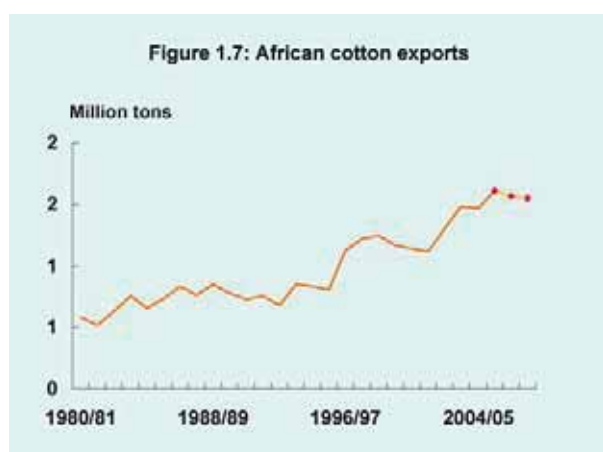

Source: ICAC.

are trending downward and are estimated at less than 200,000 tons this season. However, exports from Southern and East Africa are expanding to nearly 400,000 tons this season, and exports from the francophone region are forecast at a near record of 1 million tons. Burkina Faso is the largest exporter from Africa, accounting for 300,000 tons in 2005/06; Mali is second, with 250,000 tons in 2005/06; and Benin, Cameroon and Egypt exported 100,000 tons or more. In total, 30 countries in Africa export some cotton while 37 countries are producing cotton. Egypt, Morocco and South Africa are the largest importers and combine to account for about 160,000 tons.

As was the case for exporters around the world, during 2005/06 the largest market for African cotton exports was China, which has taken between one-third and one-half of African exports in recent seasons. Indonesia, Bangladesh, Viet Nam, Taiwan Province (China) and Thailand are also significant markets for African exports. India has become an important importer in recent years, especially for fine cottons from Egypt.

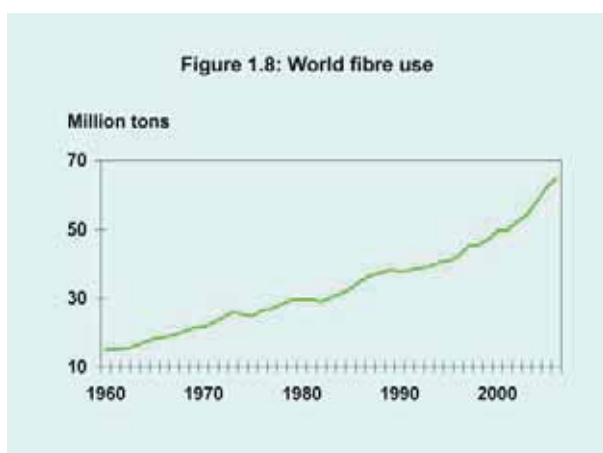

Source: ICAC.

Trends in mill use of fibre

World textile fibre consumption is driven by three major economic variables: income, population growth and fibre prices. World demand for textile fibres has increased at an impressive pace since the 1950s. From 7.6 million tons in 1950, textile fibre consumption increased to 56 million tons in 2004 (see figure 1.8). While about 50% of the increase was the result of population growth, the remaining 50% was the result of higher income per capita, declines in real textile prices, and competition, which generated new uses for textile fibres. However, the rate of growth of fibre consumption has decelerated

gradually. The average annual rate of growth of textile fibre consumption was 3.7% during the 1960s, 3.1% during the 1970s, 2.5% during the 1980s and 2.7% during the 1990s. Growth of the two major economic variables that determine textile consumption, income and population, decelerated during the 1990s compared with the 1960s.

An exogenous factor that has supported textile consumption in the last few years is the gradual integration of textile trade into World Trade Organization (WTO) rules. By December 2004, just over half of world textile trade had already been gradually integrated, and on 1 January 2005, all textile trade was integrated into WTO rules. Therefore, quotas agreed under the Multifibre Arrangement (MFA) no longer exist. Research by the International Cotton Advisory Committee (ICAC) Secretariat, using previous joint work with the Food and Agriculture Organization of the United Nations (FAO), suggests that because of textile quota elimination, the world was consuming half a million tons more cotton by the end of 2005. A large portion of the gains in cotton consumption due to quota elimination probably occurred between 1995 and 2004, particularly since January 1, 2002.

Expansion of retail cotton use

The rate of expansion of world cotton consumption accelerated for the fourth year in 2005, and did so while consumption of other fibres stagnated. World cotton consumption increased every year between 1998 and 2006.

Lower prices of cotton relative to other fibres, strong economic growth, and the popularity and greater availability of cotton products compared to products made of other fibres supported increases in cotton consumption. Contrary to the trend in the overall textile market, increases in world cotton consumption in 2005 were concentrated in developing countries (see figure 1.9). The world consumed an additional 1.8 million tons of cotton products in 2005, and of that additional consumption, developing countries accounted for 72%, industrialized countries for 26%, and Central and Eastern Europe and the former Soviet Union for 2%. As cotton consumption has increased in developing countries at higher rates in recent years, developing countries' share of the world end-use cotton market increased to more than 50% in 2005.

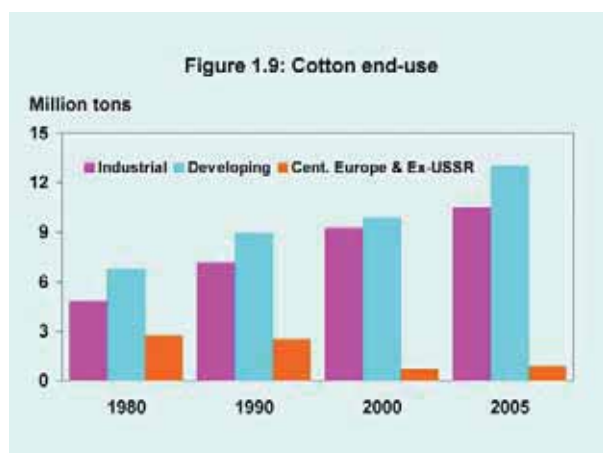

Source: ICAC.

Relative cotton prices declined between 2003 and 2005, and in 2005 cotton prices were at their lowest level relative to polyester since 1992. Importantly, cotton prices have been less volatile in recent years than they were in the 1990s. Cotton prices, as measured by the Cotlook A Index, declined from an annual average of \$0.63 per pound in 2003, to an average \$0.62 per pound in 2004 and \$0.55 per pound in 2005.

Retail cotton consumption

In 2003, developed countries as a group accounted for 44% of retail-level cotton consumption worldwide, and developing countries accounted for 52%. At the retail level, the United States is the largest consuming country, accounting for 21% of total cotton use in 2005. United States per capita cotton consumption was 17 kilograms in 2005, compared with a world average of only 3.8 kilograms. High consumer incomes, a history of cotton consumption,

consumer preferences in favour of cotton bolstered by industry advertising, and fashion trends that favour cotton explain the high level of per capita cotton use in the United States.

Retail consumption of cotton in Latin America accounted for 9% of world cotton use in 2000; per capita consumption was 3.2 kilograms per year. Consumers in Brazil and Mexico account for two-thirds of Latin American retail-level cotton use.

Retail consumption in the EU-15 accounts for 16% of world cotton use, and per capita cotton consumption in Europe was about 7 kilograms in 2000. The lower level of per capita consumption of cotton in Europe compared with the United States reflects lower average income levels, fewer consumer-oriented retail structures, and differences in tastes and preferences between United States and European consumers.

Retail consumption in the Russian Federation and other countries of the former Soviet Union accounted for 2% of world cotton use in 2000; per capita cotton use was below the world average at just 2.7 kilograms.

Retail consumption in the Middle East, including Turkey, accounted for 6% of world use in 2000; per capita consumption was equal to the world average at 3.6 kilograms.

Africa, including South Africa and Egypt, accounts for only 2% of world cotton use at the retail level; per capita consumption of cotton in Africa is less than 1 kilogram per year.

Retail consumption in Japan equalled 6% of world cotton use in 2000. Per capita consumption in Japan was 9 kilograms, 2 kilograms higher than the EU average, but lower than in the United States. Consumption in the rest of East Asia (including China) and South Asia accounted for 31% of world cotton use at the retail level in 2000, but per capita consumption averaged just 1.8 kilograms because of low incomes and government policies that favour the use of polyester to conserve land devoted to cotton. One of the great challenges for the cotton industry is to raise per capita consumption in the countries with the largest populations, including China, where cotton use per capita was just 1.9 kilograms in 2000, India, with per capita cotton use of 1.7 kilograms, and Indonesia, with per capita use of 1.4 kilograms. It is hoped that rising incomes in India, Indonesia and China will lead to increases in per capita cotton consumption during the current decade.

Mill consumption

World mill use of cotton rose from 6 million tons in the early 1950s to 26 million tons in the mid-2000s (see figure 1.10).

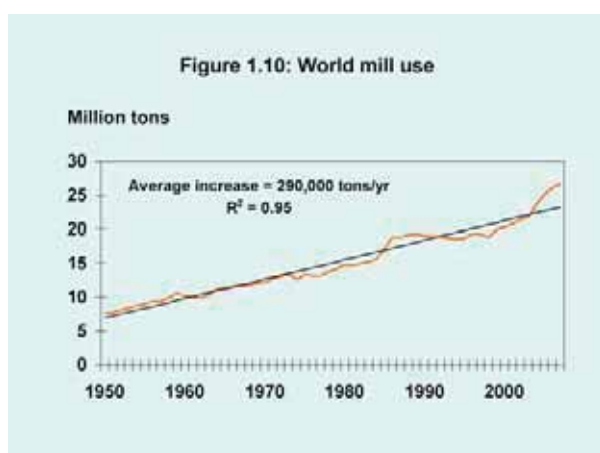

Source: ICAC.

The average rate of increase in world cotton mill use over the last six decades was about 290,000 tons per year. Mirroring end-use consumption, world mill consumption of cotton was stagnant during the first half of the 1990s, growing by only 0.6% between 1990 and 1997, but increased rapidly thereafter. In the early 1990s, mill consumption of cotton declined dramatically in Eastern Europe and the former Soviet Union, from 2.5 million tons in 1990/91 to 730,000 tons in 1998/99, offsetting gains elsewhere in the world. Mill consumption of cotton in the former COMECON group of countries (Council for Mutual Economic Cooperation), an economic grouping of the Soviet

Union, Eastern Europe, Viet Nam and Cuba, recovered to 1 million tons in 2005/06. Mill consumption of cotton in industrialized countries remained at about 4 million tons during the early 1990s, but declined rapidly after 1998/99 to 1.8 million tons in 2005/06. High cost structures and increased import competition from developing countries caused the cotton textile industries in many industrialized countries to reduce production beginning in the 1990s.

Mill consumption of cotton in developing countries increased at an annual rate of 3.9%, from 8.5 million tons in 1980/81 to 12.3 million tons in 1990/91. Growth of mill consumption decelerated during the first seven years of the 1990s to an average annual rate of 2.7%, with annual consumption reaching 14.3 million tons in 1997/98, but regained strength since 1998/99, growing at an average annual rate of 6% to exceed 23 million tons in 2006/07. The bulk of the increase since 1998 occurred in China, but important expansions were also registered in India, Pakistan and Turkey. As a result, the processing of cotton continued to be concentrated in developing countries, and their share of world mill consumption rose from 67% in 1990/91 to 90% in 2006/07, compared to 46% in 1970/71 and 28% in 1950/51.

For the past eight years, China has been the driving force of the world textile industry (see figure 1.11). Between 1998/99 and 2006/07, the increase in mill consumption of cotton in China accounted for 84% of additional consumption worldwide. The Chinese industry processed 10.5 million tons of cotton in

2006/07, an increase of about 6 million tons since 1998/99. Chinese mill use of cotton in 2006/07 accounted for 40% of global mill use, up from 23% in 1998/99. The textile industry in China is highly dependent on the export market, and China has increased its share of world textile and apparel exports in the last eight years. During the 1990s, mill consumption of cotton became more concentrated in the largest processing countries. In 1980/81, the six countries that are the largest processors today (China, India, Pakistan, the United States, Turkey, and Brazil), accounted for 51% of world mill consumption. These countries accounted for 57% of world mill consumption in 1990/91, and 79% in 2006/07.

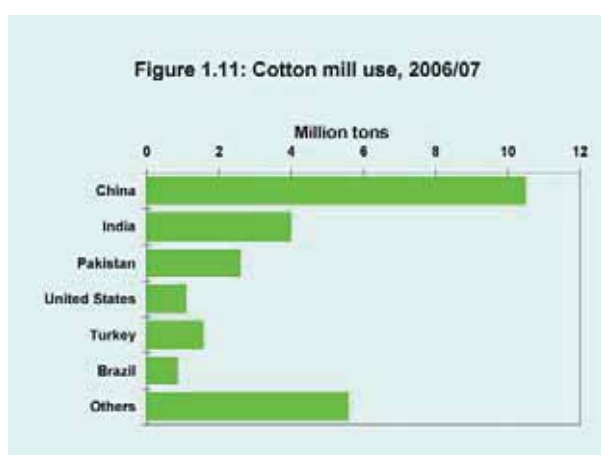

Source: ICAC.

Inter-fibre competition

Cotton faces competition from chemical fibres (see figure 1.12). At the start of the twentieth century, cotton had a dominant share of the textile market. At the

beginning of the twenty-first century, cotton is one of many fibres available and has been surpassed by polyester. Cotton consumption per capita has been almost constant since 1960, while total textile fibre consumption per capita has more than doubled.

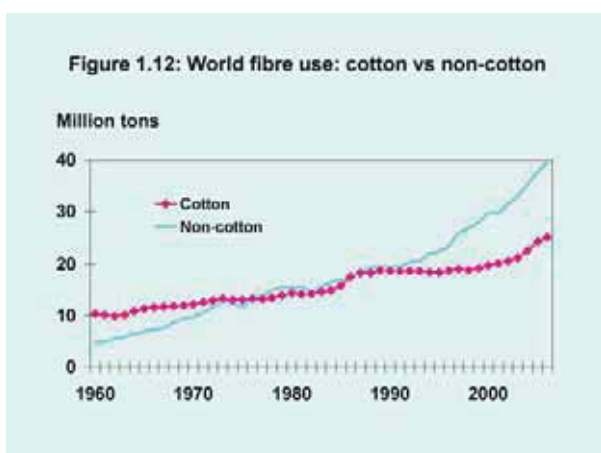

Source: ICAC.

World consumption of all textile fibres, including cotton, chemical fibres and wool, increased at an impressive pace, from 9.6 million tons in 1950 to 56 million tons in 2004. Fibres competing with cotton include natural fibres and chemical fibres, primarily polyester. Cotton's share of world textile fibre use fell from more than 70% in the 1950s to less than 50% by the end of the 1970s. Cotton did better in the 1980s, but its share of world textile fibre fell to about 40% by 2005 (see figure 1.13).

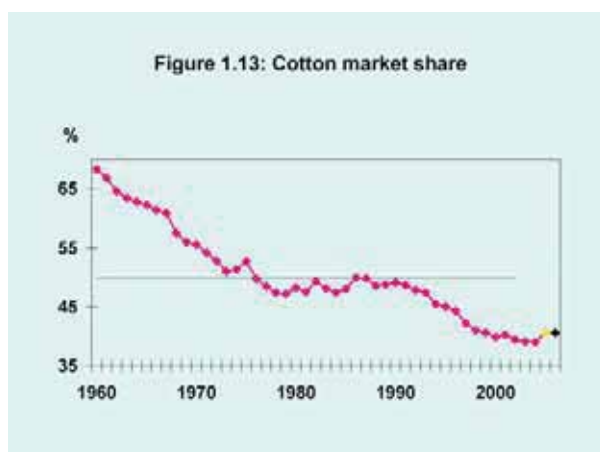

Source: ICAC.

Cotton's major advantages over its primary competitors in the chemical fibre complex include wearing comfort, natural appearance, moisture absorbency, its status as a renewable resource and the important economic role of cotton in many producing countries. However, cotton also suffers from several disadvantages in comparison with chemical fibres, including contamination introduced during harvest, ginning and handling, and annual fluctuations in the quantity and quality of production and consequent variability in prices. Cotton also has difficulty meeting the needs of modern spinning equipment for strength, uniformity and other quality parameters.

Cotton's share of world fibre use exceeded 60% in the 1960s, fell to 50% during the 1980s and dropped to less than 40% in the early 2000s. However, cotton experienced a revival in use during 2004 and 2005 linked to lower prices, and cotton's share of fibre use increased to above 40% in 2005. However, over the longer term, cotton is expected to continue to lose market share.

Long-term projections for textile fibre consumption

The set of assumptions used to project world textile fibre and cotton consumption in 2010 and 2020 includes:

- ❑ Annual average gross domestic product (GDP) growth since 1970 as a proxy for long-term GDP growth;
- ❑ Population projections from the United Nations;
- ❑ A long-term cotton price trend equal to average relative cotton prices between 2003 and 2005; and
- ❑ Increases in the ICAC Textile Fibre Price Index in tandem with inflation.

World textile fibre consumption is projected to expand at an annual average rate of 4% to reach 70 million tons in 2010 and by 2.8% per year to reach 87 million tons in 2020. Lower rates of growth in world textile fibre consumption are mainly associated with lower world GDP growth (down from 5.3% during the 1960s to 3.3% during the 1990s) and lower growth of the world population (from 2.1% during the 1960s to 1.7% during the 1990s). Between 2000 and 2005, the average rate of growth of textile fibre consumption was 3.8%. World cotton consumption is projected to expand at an annual average rate of 2% to reach 26.7 million tons in 2010 and 32 million tons in 2020. Cotton's share of the world textile fibre market is projected to decline to 37% in 2020.

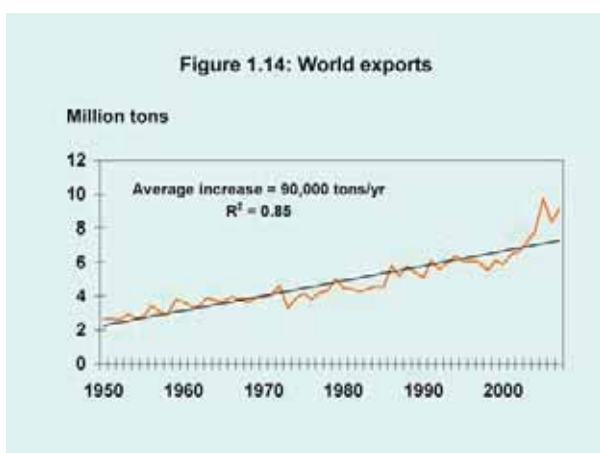

Source: ICAC.

Trade

World trade in cotton rose from 2.6 million tons in 1950/51 to 4 million tons in the early 1970s and reached 5.8 million tons in 1986/87. Cotton exports averaged 5.9 million tons during the 1990s and climbed to a record of 9.7 million tons in 2005/06 (see figure 1.14). Among the top seven cotton-producing countries, only Uzbekistan does not rank among the top seven consuming countries. Trade accounted for 40% of world cotton production in 2005/06, and the value of world exports was approximately \$12 billion.

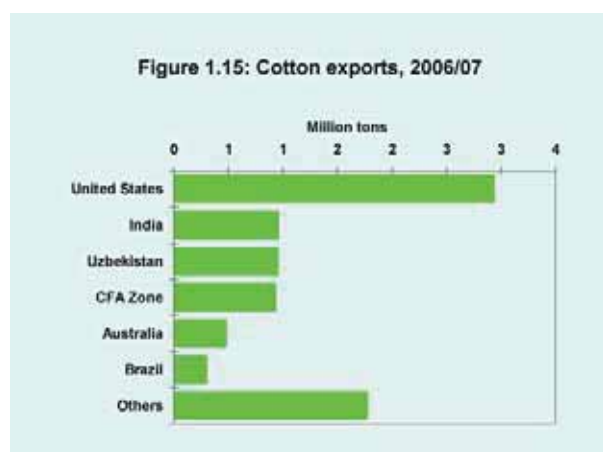

Source: ICAC.

World trade in cotton is projected at 8 million tons in 2006/07 (see figures 1.14 and 1.15). Production is falling behind mill use in China, Pakistan and Turkey. These three countries accounted for 15% of world imports in 2000/01 and for an estimated 40% in 2006/07, while imports by the rest of the world declined.

The largest and most significant impetus to the growth of world trade in cotton is provided by a sharp increase of cotton use in China. A record surge of cotton imports by China to 4.2 million tons, or 44% of world imports, in 2005/06, led world trade to a record. With the reduction of stocks in China to minimum levels, the Government began to provide full support to

imports by issuing sufficient import quotas as a measure to balance supply and use, reduce domestic prices, and make the textile industry more competitive.

For the fifth season in a row Turkey is the second-largest importer of cotton, accounting for 700,000 tons or 8% of world imports in 2006/07. Between 1998/99 and 2004/05, mill use in Turkey rose by 450,000 tons and reached 1.55 million tons. However, Turkey also faces competition in textile exports from Asian suppliers, and mill use in 2006/07 is estimated at the same level of 1.55 million tons. Because cotton production in Turkey remains behind increasing use, imports remain a significant source of supply.

India became one of the leading importers of cotton starting in 1999/2000 because of reduced production due to reduced planted area and drought. During the same period, Indian mill consumption was stable at around 2.9 million tons, supported by strong exports of cotton yarn and textile exports to Asian markets, the United States, Canada and Mexico. In 2001/02, India imported 520,000 tons of cotton, accounting for 8% of world imports. Indian area and yields rose during 2004/05, resulting in a crop of 3.9 million tons; as a result of increased domestic supply, imports by India declined to 150,000 tons. By 2005/06, production in India had begun to exceed mill use and instead of importing cotton, India exported 700,000 tons, the third-highest total in the world. Indian exports in 2006/07 are estimated at 960,000 tons.

Cotton consumption in Pakistan continues to expand rapidly in response to export-driven demand. Between 1998/99 and 2006/07, mill use in Pakistan rose by 6% a year to an estimated 2.6 million tons.

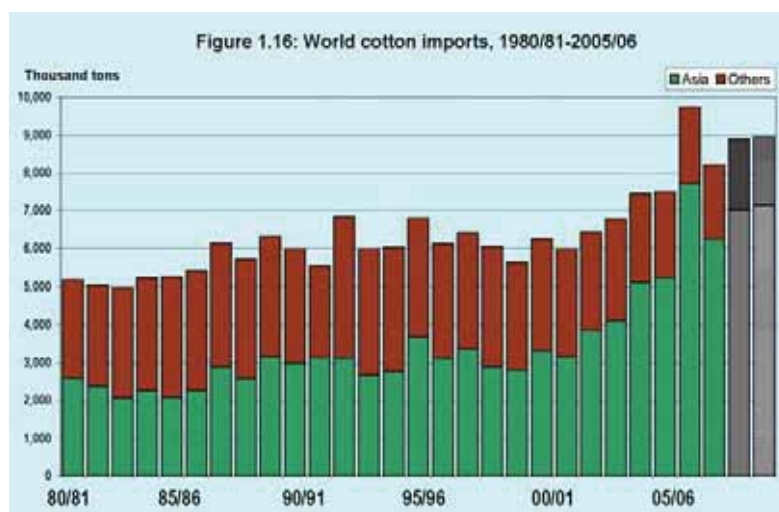

Source: ICAC.

World cotton imports are projected to reach 9 million tons in 2007/08, the second highest level of imports since the record of 9.7 million tons was reached in 2005/06 (see figures 1.16 and 1.17). Increased production in importing countries led to a decline in world imports to 8.2 million tons in 2006/07 as a result of a record domestic supply. China (Mainland) contributed the most to the increased supply and reduced world imports in 2006/07 as a result of a record domestic supply. China (Mainland), Turkey, Bangladesh, Indonesia, Pakistan and Thailand became the largest cotton importers during the past decade. Cotton

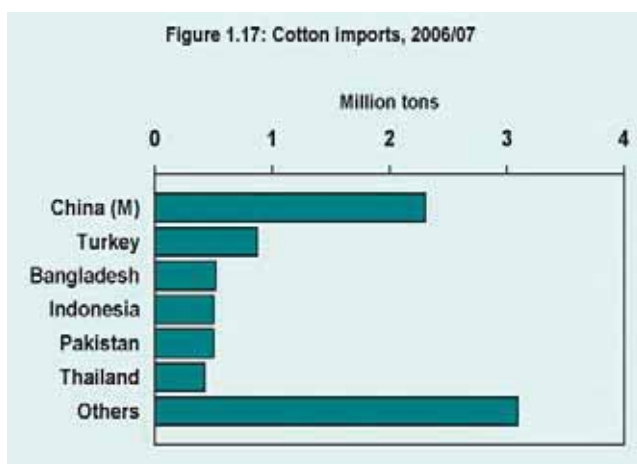

Source: ICAC.

production in these countries was not able to meet growing mill use. Substantial changes in cotton trade flows occurred during the past decade. Industrial countries (North America, Western Europe, Australia and Japan) accounted for 28% of world imports and 36% of world exports in 1998/99. The decline in mill use in industrial countries, and the rapid expansion in Asia, led to a major shift in the destination of world imports. In 2006/07, industrial countries accounted for 8% of world cotton imports and 45% of world exports. The share of industrial countries in world trade is projected to change to 7% and 46%, respectively during 2007/08. Asia became the primary destination of cotton shipments during

the past decade. In 1998/99, Asia accounted for 65% of world mill use, 50% of world imports and 10% of world exports. In 2006/07, Asia accounted for 81% of world mill use, 76% of world imports and 15% of world exports. It is projected that in 2007/08, Asia will account for 82% of mill use, 79% of world imports and 16% of exports.

The largest share of increased world import demand is being met by exports from the United States. Large supplies of cotton in the United States and declining mill use led to record United States exports of 3.8 million tons in 2005/06. United States exports are estimated at 2.95 million tons in 2006/07 because of smaller production in the United States and reduced imports by China.

The next largest exporters are India, Uzbekistan, Australia, West Africa and Brazil. Exports from Uzbekistan were mostly declining, from 1.3 million tons in 1992/93 to 660,000 tons in 2003/04. The reason for the steady decline in exports was a decline in production and increased mill use. In 2004/05 and 2005/06, production in Uzbekistan rebounded and exports increased to 1 million tons, accounting for 10% of world exports. Cotton area in Uzbekistan is projected to remain stable during the next several seasons. At the same time, Uzbekistan is expected to continue expansion of spinning capacity, increasing utilization of cotton domestically and reducing the availability of supplies for exports.

Between 1991/92 and 2002/03, Brazil was a net importer of cotton. During the past several seasons cotton production has begun to rise rapidly because of new, high-yielding commercial production in central Brazil, including the state of Mato Grosso. In 2003/04, cotton production in Brazil exceeded consumption by almost half a million tons, and exports by Brazil rose to 430,000 tons in 2005/06.

Exports from the CFA zone (francophone Africa) reached a record of more than 1 million tons in 2003/04 and exports were above 1 million tons again in 2005/06. The region is experiencing a reorganization of its cotton sector as several countries adopt policies encouraged by the World Bank and donor countries to encourage privatization. Production in francophone Africa may decline in coming years. Lower market prices for cotton, caused partly by subsidies paid in developing countries and partly by a weakening of the United States dollar against the CFA, are a particular source of dissatisfaction among African producers.

Australian production has suffered from severe drought during the past several seasons, leading to a sharp decline in exports. In 2004/05 Australian exports fell to 435,000 tons, compared with 850,000 tons in 2000/01. Exports from Australia are projected at 500,000 tons during 2006/07 as stocks are being drawn lower. Australia accounted for only 7% of world exports in 2004/05, compared with 14% during 2000/01.

Biotech cotton in world textile trade

New technologies, more extensive use of existing technologies, and new areas dedicated to cotton cultivation have changed the structure of the world cotton

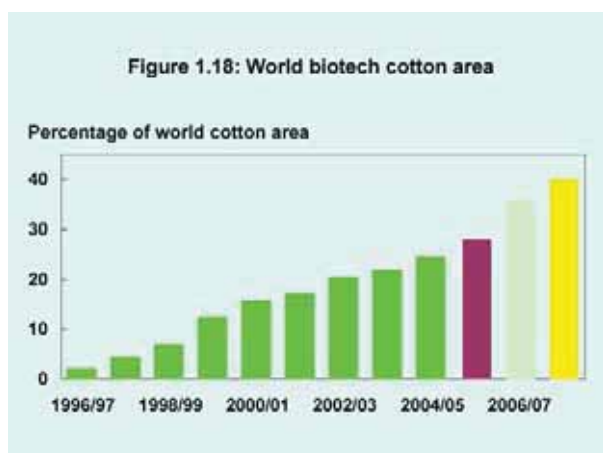

Source: ICAC.

market since the mid-1990s. Among the new technologies, the most visible is genetic engineering of cotton. It is estimated that 36% of world cotton area, accounting for nearly half of world production, was planted in biotech varieties in 2006/07, up from just 2% in 1996/97 (see figure 1.18). Biotech cotton reduces the use of insecticides and, although it does not guarantee that cotton yields will be higher than with a non-biotech variety, its use might lower the cost of production.

Biotech cotton is entering the world textile trade pipeline in increasing volumes as a result of growing world production and exports from the United States and Australia, and textile exports from China. Based on the production shares of

biotech cotton in exporting countries, it is estimated that biotech cotton accounted for 45% of world exports in 2005/06. Biotech varieties are expected to account for 40% of world cotton area and close to half of world production in 2007/08.

Based on domestically produced and imported biotech cotton, especially in China, it is estimated that 60% of mill use in Asia and Oceania was accounted for by biotech cotton. Asia and Oceania together account for more than 65% of world exports of cotton textiles, so it is evident that the share of biotech cotton in textiles traded in major markets in Europe and America is rising. Despite an increasing share of biotech cotton traded in the world, there are no price differentials for biotech and non-biotech cotton fibre, or textiles containing biotech cotton. There is no evidence of rejection of biotech cotton by any segment of the market or region. In practice, markets do not identify biotech cotton content, but rather evaluate cotton properties based on quality characteristics.

Government measures

An important factor explaining the location of cotton production in relatively high-cost countries is government measures that distort production and trade. Direct income and price supports for cotton worldwide ranged from \$3.8 billion

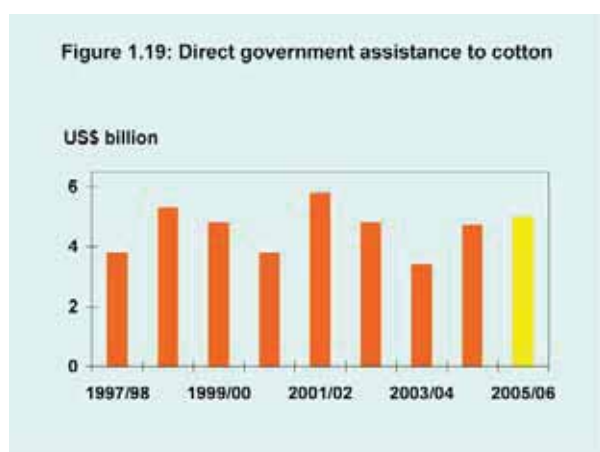

Source: ICAC.

in 1997/98 to \$5.8 billion in 2001/02. For 2005/06, direct income and price support programmes for cotton are estimated at \$5 billion (see figure 1.19). Fourteen countries, representing three-quarters of world cotton production, offered direct income and price support programmes to cotton growers in 2001/02, a season of record low prices. This resulted in higher production and forced the burden of adjusting to low cotton prices on to growers in countries that did not provide similar measures of protection.

In 2005/06, the greatest government assistance per pound of cotton production was provided by the EU to producers in Greece and Spain, with support averaging \$0.75 per pound of lint

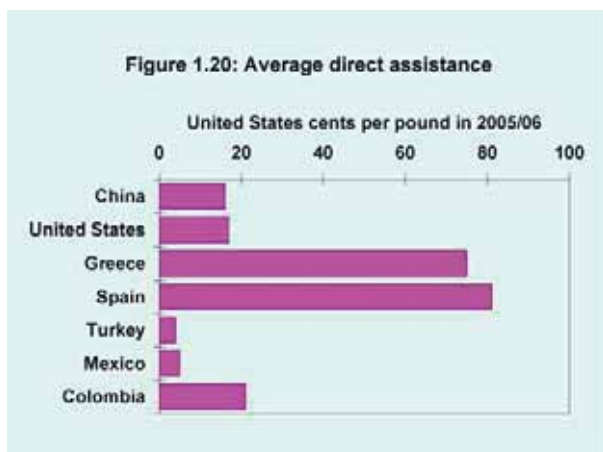

Source: ICAC.

production, or approximately \$900 million in total (see figure 1.20). The EU announced in 2004 that 65% of the value of support for cotton would be paid to farmers directly and decoupled from current cotton production beginning in January 2006. This means that, beginning in 2006, cotton farmers in Greece and Spain received 65% of the support they used to receive, whether or not they continued to produce cotton, and only 35% of government support was based on current production. This change, known as decoupling, is leading to lower production. The EU produced 500,000 tons in 2004/05, and cotton production is estimated at 370,000 tons in 2006/07. Part of the decline in production during 2006/07 was due to poor weather, especially in Spain.

In 2005/06, direct support to cotton farmers in the United States averaged US\$ 0.17 per pound of production. The total value of direct support was US\$ 1.92 billion. Support in the United States included payments to farmers based on the difference between average farm prices and a target price. United States growers also received a fixed payment based on historical production. Like Europe, the United States does not attempt to restrict cotton imports in an effort to bolster domestic prices. Elements of the United States cotton programme came under specific criticism from the international community during the Doha Round of WTO trade negotiations because of the unique role played by cotton in the economies of many developing countries. During the Doha Round, the United States agreed to lower or eliminate subsidies to cotton, but only within the context of an overall agreement on agriculture. Unfortunately, by May 2007, the Doha Round had not been concluded because of a lack of an international consensus on trade reforms.

The value of government support for China's cotton sector is estimated by ICAC at \$0.16 per pound in 2005/06, or about \$2 billion. In contrast to Europe and the United States, China does not provide direct payments to cotton growers but instead uses a complex system of import quotas and licenses to restrict trade and maintain domestic prices above the world level. The Government of China reports to the WTO that it does not subsidize cotton. The differentials between international prices and equivalent domestic prices in China, adjusted for quality and common location, are documented including by ICAC and others.

Government measures that boost cotton production have a negative effect on average international cotton prices in the short run. Estimates vary on the size of the impact, but most economists agree that the elimination of subsidies would raise average cotton prices by 5%–20%, and some estimates are higher.

However, if subsidies were eliminated, production would expand in other countries within two to three seasons in response to higher prices, and many researchers feel that the long-run impact of government measures on cotton prices is probably smaller than the short-term impacts. Nevertheless, the distortions to cotton production caused by government measures are significant. In the absence of government support for cotton and other commodities, cotton production in the United States would decline by an estimated one-third over several seasons, and production in China would probably fall by about one-tenth. As a consequence, between two and three million tons of cotton production would shift from Europe, the United States and China toward lower-cost producing countries if government measures were eliminated.

The importance of cotton in world trade

Cotton is essentially produced for its fibre, which is universally used as a textile raw material. Cotton is an important commodity in the world economy. Grown in more than 100 countries, cotton is a heavily traded agricultural commodity, with over 150 countries involved in exports or imports of cotton. The six largest consuming countries are also among the top seven producing countries. Cotton trade accounted for about 30% of world output from 1980/81 through 2004/05, but this share rose to almost 40% in 2005/06.

As world cotton production inevitably varies from year to year, variations in supply can cause wide fluctuations in price. The estimated nominal value of world exports dropped from a high of \$13 billion in 1994/95 to \$6 billion in 2001/02 and rebounded to approximately \$12 billion in the 2005/06 marketing season (August-July). World cotton trade is not highly concentrated compared to other commodities. About 500 firms are involved in cotton exports worldwide.

World cotton exports reached 3.6 million tons in 1926/27, and that level was not surpassed until the early 1950s. Exports climbed to 9.8 million tons in 2005/06. The United States plays the leading role in cotton exports. Raw cotton was the United States' largest merchandise export from 1803 through 1937, and the United States has been the largest cotton exporter since 1834 (with only one exception in 1985/86).

Cotton is also a very political crop because of its importance in world trade and to the economies of many developing countries. In many countries, cotton exports not only are a vital contribution to foreign exchange earnings but also account for a significant proportion of GDP and tax income. Cotton is playing a major role in economic development in Africa: 37 of the 53 African countries produce cotton and 30 are exporters. Most Central Asian republics from the former Soviet Union are also very dependent on cotton exports.

Based on average export values in 2004/05, cotton was among the top three export products in 10 countries, and the average share of cotton exports in total product export earnings exceeded 10% in seven countries.

Country	% of product exports	Rank of cotton
Burkina Faso	71.5	1
Benin	63.2	1
Mali	35.6	2
Zimbabwe	12.4	2
Togo	11.7	2
United Republic of Tanzania	6.4	4
Uganda	5.7	4
Cameroon	5.6	6
Zambia	5.4	3
Malawi	3.8	4
Sudan	2.5	4
Côte d'Ivoire	2.2	10
Burundi	1.8	4
Ghana	0.8	10
Central African Republic	0.7	8

Source: UNCTAD.

Nevertheless, cotton represents a very small share of world trade in terms of value. In UNCTAD export statistics by product, cotton ranked 170th on average 2004/05 values, accounting for 0.11% of world product exports in 2005 (\$11.4 billion).

The cotton export market is relatively concentrated. With an index value of 0.386 in 2005, cotton is ranked twenty-first among all commodities according to the concentration index calculated by UNCTAD (an index value that is close to 1 indicates a very concentrated market; values closer to zero reflect a more equal distribution of market share among exporters or importers). The cotton import market is less concentrated. With a concentration index value of 0.294, cotton is ranked thirty-fourth among all imported commodities. However, the structural change index value of 0.378 in 2005 reveals a significant change in the composition of importers compared to the reference year (1995).

The ICAC Secretariat has studied the structure of world trade since 1994 and compiles a list of cotton-trading companies every year. The world cotton industry is not very concentrated by the standards of industrial markets and the international cotton shipping industry is highly competitive. About 500 firms are engaged, at least in part, in international trade in cotton.

Cotton prices

Cotton prices measured at many levels

When people in the cotton market speak of prices, they are usually referring either to the Cotlook A Index or to the latest prices quoted for the nearby futures contract on ICE Futures U.S., Inc. in New York. However, on any day there is a constellation of cotton prices determined by quality, location and delivery schedules, and relationships between prices in the supply chain change constantly.

The Cotlook A Index is the most often quoted indicator of the average level of international prices. The A Index is compiled by employees of Cotlook Ltd, a private company in Liverpool, United Kingdom, who receive price information from both buyers and sellers of cotton from many origins. Often the price quotes reported to Cotlook vary by wide margins, especially for cottons from origins with little volume. In these cases, the Cotlook employees must exercise their own judgement to determine the prevailing offering rate for cotton from each origin. To calculate the A Index, Cotlook averages the offering values of the cheapest five origins delivered to East Asia for nearby shipment for middling grade cotton of 1–3/32" in length. It is widely understood that actual transaction prices could be lower than the offering values quoted by Cotlook, but the A Index is still respected as a valid indicator of average price levels. Cotlook also quotes an A Index for North Europe and a North Europe B Index for shorter staple cotton. Both North Europe Indexes will be discontinued after 31 July 2008.

In contrast, futures prices represent actual transactions prices for United States cotton of a very specific description delivered to specific locations on specific dates. Futures prices are determined by open outcry in a trading pit, or by public auctions conducted over computer networks. As a consequence, there is no judgement involved in reporting prices. On the other hand, futures prices are very specific to the type, quality, location and time of delivery. Therefore, futures prices are not always good indicators of international price trends or prices of cotton from countries other than the United States.

Mill-delivered prices and prices received by farmers can vary substantially from quoted international values. Prices for cotton delivered to mills include the costs of transportation, storage, insurance, interest costs, loading and unloading required to deliver bales directly to mill warehouses. Some mills buy an entire year's worth of cotton at the start of each season and incur the costs of storage, interest and insurance internally. Other mills buy and schedule delivery week-to-week, and prices for services are negotiated in each contract. Farm prices in developing countries are usually quoted to farmers on the basis of seed cotton delivered to collection points. In such cases, prices paid are lower than prices paid for lint to account for the cost of ginning, and delivery of lint and seed to markets. In some countries, farmers are paid on a lint basis after ginning. In all cases, prices for individual lots of cotton will reflect discounts or premiums for quality different from the base qualities quoted in international markets.

Influence of time on prices

As the old saying goes, 'Time is money.' In the cotton world, the average cost of storing a pound of cotton lint for one month, including warehouse, insurance and interest costs, works out to between 0.5 cents and 2 cents. This amount varies substantially among countries, depending on interest rates, storage costs and insurance costs. Countries with high rates of interest have implicitly high costs of storage because of the foregone income on sales that cannot be put on deposit in a bank. Consequently, the seller of a bale will need more money for a sale several months in the future than for a sale involving prompt delivery in order to have the same net revenue. In some countries, cotton warehouse costs are treated as sunk or fixed costs, and there are no charges for storage, but in other countries, the cost of warehouse space is charged per month. Likewise, insurance can be purchased in some countries but not in others, and risks of theft, fire, flood or other forms of damage are higher in some regions than in others. Accordingly, insurance costs vary by location. Consequently, prices for a specific bale of cotton at a specific location can vary substantially based on whether the sale is for immediate delivery or future delivery.

Spot sales and purchases

Worldwide, the most common type of sale or purchase is probably 'spot', or a cash sale for current delivery. Most seed cotton is sold by farmers for cash on delivery. However, in many developing countries, prices are established before harvest, and farmers are paid months after harvest, but the price is still based on the assumption of delivery at harvest. Likewise, many textile mills establish prices paid based on immediate delivery, sometimes with delayed payment depending on terms negotiated with sellers.

Forward cash sales and purchases

Forward cash sales involve commitments to deliver or take delivery of cotton in the future at a price determined today. Farmers are often able to sell in advance of harvest, sometimes with pre-finance of inputs provided by buyers. Textile mills can arrange for the scheduled delivery of cotton in the future, with prices fixed at the time of negotiation.

On-call sales and purchases

Another common form of transaction in markets where it is possible to use the cotton futures contract traded on the ICE Futures U.S. is an on-call sale or purchase. In these instances a seller will negotiate the difference between the cash price and the futures price (called the basis) with the buyer, with the understanding that the seller can 'call' the buyer any time prior to expiration of

a particular futures trading month and fix the actual cash price based on the futures price quoted at the time of the phone call. Similarly, a buyer can ‘call’ the seller to fix the actual price for delivered cotton based on futures prices quoted at the time of the phone call. On-call transactions allow buyers and sellers to eliminate the risk that cash prices in a local market could move differently than futures prices for United States cotton delivered to United States locations, and thus improve the efficiency of the futures contract as a hedging tool.

Marketing pools

There has been substantial growth in the use of cooperative marketing pools during the last 20 years. Marketing pools are usually operated by farmer-owned cooperatives, but they can also be offered as a marketing option by ginners and merchants. Individual farmers place some or all of their cotton lint under the control of the managers of the marketing pool. The managers sell cotton from the pool, and each farmer receives an average price for the season adjusted for the particular quality delivered. Marketing pools are offered in the United States, Brazil, Argentina, Colombia, Greece, Israel, Australia and other countries where farmers sell lint instead of seed cotton. In 2006, an estimated 40% of United States cotton was sold through some form of cooperative marketing pool, including those operated by farmer-owned marketing cooperatives, as well as the pools operated by private merchants under contract to a group of farmers in a particular region.

Marketing pools are popular because they offer substantial economies of scale in marketing. A marketing pool representing several hundred thousand bales of cotton can afford to employ professional managers whose full-time jobs are to market cotton. They can also tailor cotton sales and deliveries to the quality and shipping preferences of individual textile mills. In contrast, a single producer with only a small quantity of cotton to sell cannot afford to hire a professional marketing manager and cannot easily meet the quality demands and timely delivery preferences of textile mills. Marketing pools also offer the advantage of a form of price risk management, since each producer will receive the average price achieved by the entire pool and does not have to worry that his or her particular cotton was sold when the market price was lowest in the season. By placing cotton under the control of a marketing manager, the farmer is then free to focus on production.

Influence of location and quality on prices

Just as time affects costs, and thus prices, location and quality also affect the price received or paid for cotton. It costs money to move a bale of cotton, including the costs of placing a bale into a container at origin and then taking it out at destination, loading and unloading the container onto a ship, rail car or truck, moving the container, providing documentation, and completing financial transactions for each shipment, ensuring adherence to phytosanitary regulations and insuring against risk during movement and storage while in-transit. The costs of moving cotton can vary from a few United States cents per pound of lint for cotton moving by truck or rail a few hundred kilometres within a developed country from producing area to textile mill, or it can cost 10–15 cents per pound for cotton moving from a landlocked developing country by truck, rail and ship to an importing country in a different continent. In general, countries with direct access to ocean ports and better infrastructure have lower transportation costs than countries that are landlocked or have less developed infrastructure. In general, countries with large textile industries (China, India, Pakistan, Turkey, United States, Brazil) will tend to have lower transportation costs than countries that must export or import cotton from long distances.

In most cases, producers or sellers pay the costs of transportation. Importers can choose from varied origins, and so mill-delivered prices for cotton of similar quality tend to be closely matched, regardless of the cost of transportation from the producing area. Producers are able to charge higher prices only to the extent that competing producers cannot supply cotton at a lower price.

Quality differentials also affect prices for each bale of cotton. Cotton grading systems have developed over the last two centuries in each country, and in 2007 there are no truly universal, objective quality evaluation standards in the cotton industry that can be used to map a single international schedule of premiums and discounts. However, there are some basic guidelines that most people in the cotton industry understand intuitively. For instance, the market price for cotton in the extra-fine category (premium cottons from Egypt, Peru, Israel, the United States, the Sudan, China, India and other countries accounting for about 3% of world production) currently has a premium over the Cotlook A Index of about 100%; in other words, prices of extra-fine cotton are approximately double the price of average cotton. Over the last 15 years, premiums for extra-fine cotton have ranged from 35% above the Cotlook A Index to 135% above the A Index. (See figures 1.21 and 1.22.)

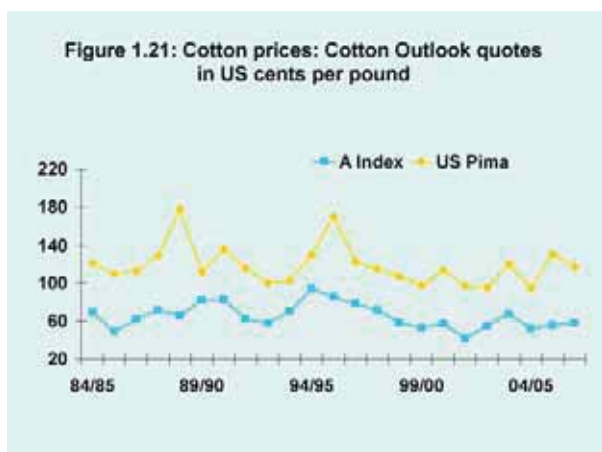

Source: ICAC.

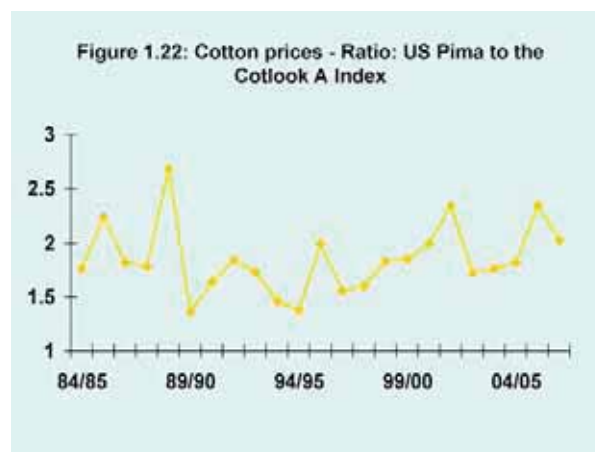

Source: ICAC.

While comparisons are not precise, it can generally be noted that prices for cotton in the fine category (cotton that is finer, longer and stronger than the world average, but not as good as extra-fine) are above the Cotlook A Index by 10%–15% in most years. Finally, cotton that is classified as coarse cotton (cotton that is shorter, rougher and weaker than average) has a discount from the Cotlook A Index of 3%–10%. Within these broad guidelines, the specific premiums and discounts for each lot of cotton bales can vary with the specific characteristics of each producing region, relative tightness of supply in each category, time of year, availability of transportation and other factors.

Cotton and competing crop prices

Wheat, maize, soybean, rice and sugar are the major world crops that compete with cotton for planted area, and cotton area will shift up and down depending on relative crop prices. To compare aggregate, or world, price trends among crops, ratios of the Cotlook A Index, converted to dollars per metric ton, are divided by prices for metric tons of wheat, maize, soybeans and sugar at ports in the United States, and rice in Thailand.

Since January 2000, a ton of cotton has cost on average about 8 times as much as a ton of wheat, although the ratio has ranged from 12 down to 6. In 2007, grain prices are relatively high relative to cotton prices because of interest in

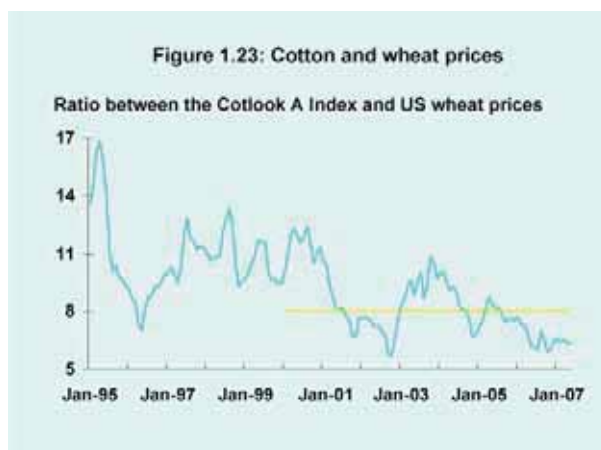

Source: ICAC.

biofuels, and so the average price of cotton is currently only 6 times greater than the average price of wheat (see figure 1.23). A ton of cotton is usually worth 12 times more than a ton of maize, but the ratio of cotton to maize prices has ranged from 18 to 7 this decade. Because of the current interest in biofuels, the cotton to maize price ratio is only 8 in 2007 (see figure 1.24). A ton of cotton is usually worth 5 times as much as a ton of soybeans, 6 times as much as a ton of rice and 7 times as much as a ton of sugar. Again, because of interest in biofuels, a ton of cotton is worth only 4 times as much as a ton of soybeans or a ton of rice in 2007, and only 6 times as much as a ton of sugar on world markets (see figure 1.25).

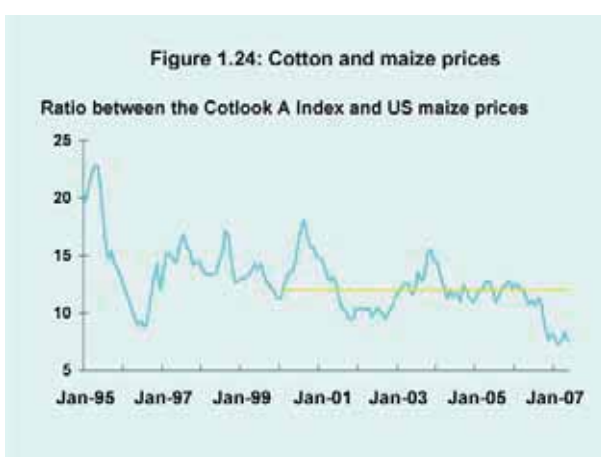

Source: ICAC.

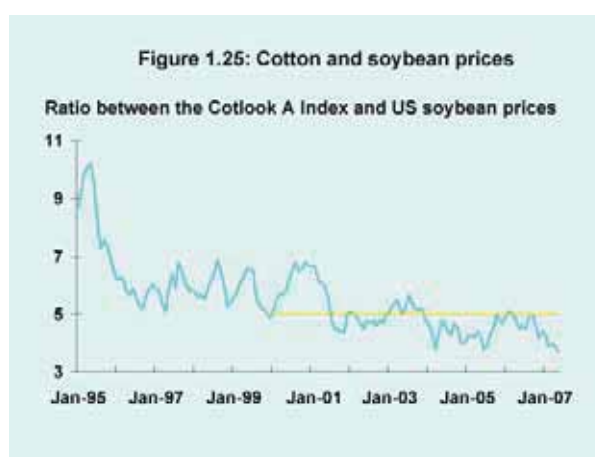

Source: ICAC.

Structural changes leading to lower real world cotton prices

The price of cotton, adjusted for inflation, is tending downward over the long run. This is a phenomenon common to many primary commodity industries and results naturally and inevitably from market forces in a competitive world economy. If inflation is considered, cotton prices have been falling since the 1950s. Estimates of average prices were more than \$3 per pound of lint in today's dollars in the early 1950s, prices fell to \$1–2 in the 1970s, and the average Cotlook A Index in 2006/07 is about 58 cents per pound (see figure 1.26). In nominal prices, or not adjusted for inflation, the Cotlook A

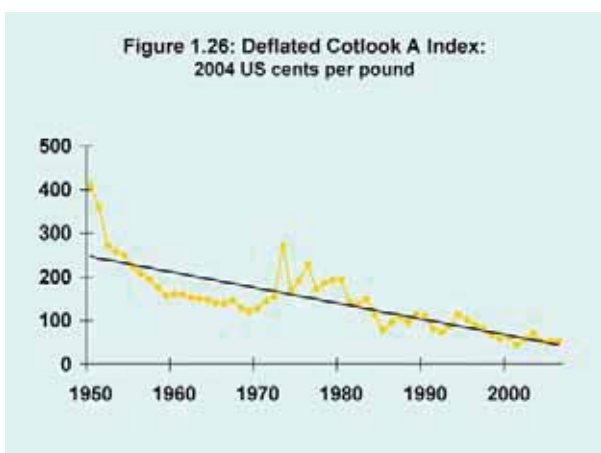

Source: ICAC.

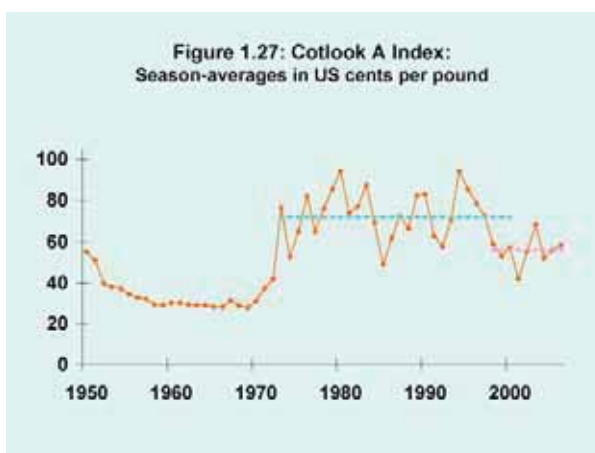

Source: ICAC.

Index averaged 70 cents per pound during the 30-year period from 1973/74 through 2002/03 (see figure 1.27). However, while there is always substantial year-to-year variation, average cotton prices during the current decade are forecast to be 10–20 cents per pound lower than the average of the last 30 years.

Technology

The long-run decline in real commodity prices is linked to technology change in agriculture, competition with substitute fibres and possibly also to reduced prices for cotton products at the retail level. Since the Second World War, agriculture has been transformed by increased mechanization, expanded use of chemical fertilizers, the development of pesticides and in developed countries the extension of electricity to rural areas that has allowed the use of electrical machinery in irrigation. The process of technology change is continuing, and may even be accelerating.

The most visible of the new technologies is biotechnology. Biotech cotton varieties accounted for an estimated 36% of world cotton area in 2006 and about 45% of world production. Biotech cotton is primarily risk-reducing and cost-reducing in developed countries, leading to larger area and greater production. In developing countries, biotechnology also enhances yields by offering improved levels of protection against insects in areas where chemical controls were inadequate.

Production in East China, affected in the early 1990s by resistance among bollworms, climbed about 300,000 tons between 1999/00 and 2000/01 largely because of the adoption of Bt (*Bacillus thuringiensis*) varieties, and biotech varieties in China are now planted on 70% of the cotton area. Biotech varieties account for about 90% of area in Australia, South Africa and the United States, 25% in Argentina, 60% in Mexico and about 40% in India. Field trials are underway in other producing countries, including Brazil and Pakistan, and biotech cotton varieties will probably account for half of world production by 2007 or 2008.

Incremental advances in proven technologies such as irrigation management, pesticide formulations and pesticide applicators, low-till and no-till production systems, crop rotations and other management techniques are also contributing to lower production costs and expanded cotton production. All of the technologies are being enhanced by the revolution in information technology, making possible great improvements in management efficiency and control of input applications. The new technologies result in an expansion of supply at each level of cotton prices, resulting in lower average prices.

Polyester

Competition is at the heart of a market economy. Timber must compete with fabricated wood products and the development of plastics. Coffee and tea must compete with each other, and with milk, soft drinks, powdered drinks, orange juice and other choices. Copper must compete with fibre optic cables. Sugar competes with corn sweeteners and artificial sweeteners. Cocoa must compete with other types of candies. Grains compete with each other and with oilseeds, and other examples of competitive pressures affecting natural commodity industries abound.

For cotton, competition with polyester is a challenge that is accelerating as technology results in lower costs of polyester production and an increased range of uses for chemical fibres. Production of all fibres other than cotton rose from 5 million tons in 1960 to 10 million in 1970, 16 million in 1980, 19 million in 1990, and then leaped to 30 million in 2000. Non-cotton fibre production was estimated at 37 million tons in 2006.

Cotton use rose at an average rate of 4% per year from 1998/99 through 2006/07, compared with average world population growth of 1.7% per year. Cotton use per capita increased to a record 3.8 kilograms in 2005. Many factors affect end-use demand, including income and consumer preferences,

but cotton as a commodity industry must remain price-competitive with polyester and other chemical fibres, and so cotton has experienced declines in real prices over time.

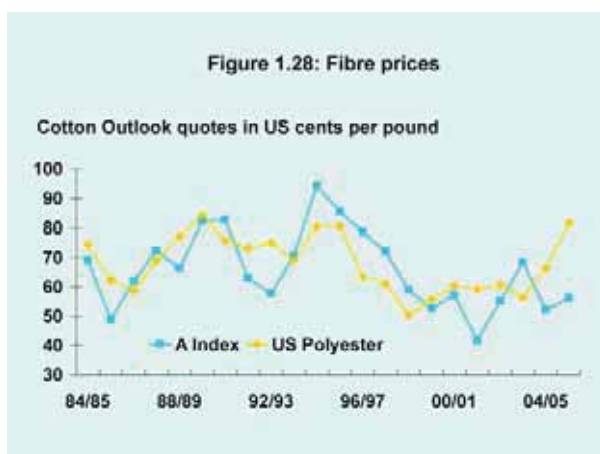

Source: ICAC.

Relative fibre prices are extremely important in determining fibre market shares. During most years in the 1980s and 1990s, cotton prices were higher than prices of polyester, explaining much of the decline in fibre market share for cotton during those years. However, since 1998/99, cotton prices have been lower and polyester prices have been higher. As a consequence, cotton consumption rose at an average rate of 3.7% per year during the period from 1998 to 2006, compared to average growth of 1.5% per year in the two decades prior to 1998 (see figure 1.28).

One common area of misunderstanding is the relationship between oil prices and prices of polyester fibre. Many people assume that, because polyester is derived from chemicals refined from oil, increases in crude oil prices lead to increases in polyester prices. However, the precursor chemicals used to make polyester account for only a small fraction of oil consumption, and each of the chemicals has multiple uses. As a consequence, there are separate markets for the chemicals used to make polyester, and those markets have little correlation with oil prices. Therefore, prices for polyester fibre are not determined by the price of oil, and in fact there is almost no statistical correlation between oil prices and polyester fibre prices.

Prices of cotton yarn

Almost all cotton is spun into yarn as the first step in the manufacturing process. (About 5% of world cotton production is used as padding in clothing, mattresses or other home furnishings, and a very small quantity is lost to fire or flood. In addition, use of cotton lint in non-woven applications, such as medical uniforms, non-woven cloth and filters is rising, and may account for another 5% of world cotton use.) Prices of cotton yarn quoted 'free on board' (FOB) the textile mill loading dock vary from just 50 cents or 60 cents per pound for low quality coarse yarns used in mops or rope to as much as \$15 per pound for extraordinarily high quality fine yarn used in expensive lingerie or shirting fabrics. While the range in yarn prices is wide, the average price for a 20-count yarn to be used in common woven cotton fabric is usually between 1.5 and 2.5 times the price of cotton on world markets. Therefore, when the Cotlook A Index is 60 cents per pound, the average cost of average quality yarn is between 90 cents and \$1.50 per pound on the loading dock.

There are no futures contracts in cotton yarn, and so no public trading data are available, and most companies are loath to divulge their private financial results. Further, the range of yarn types and qualities is much greater than the range of qualities for cotton, making it more difficult to determine average yarn price levels. For instance, there are yarns for weaving and knitting, carded yarns and combed yarns, singles and doubles, ring spun yarns, open end yarns, air-jet spinning and other types as well as weights. Therefore, information about yarn prices is gleaned from trade publications based on word-of-mouth reports from the sales yarn industry. In many markets, less than half of cotton yarn

production is sold as yarn. Instead, much yarn produced around the world is first woven or knitted into cloth by the same company before being sold. Thus data on yarn prices are difficult to estimate, and ranges are often published by major textile industry magazines and trade journals.

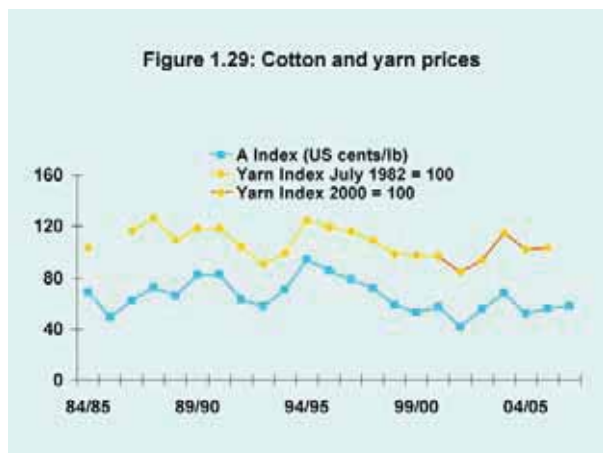

Source: ICAC.

One published indicator of cotton yarn prices is the Cotlook Yarn Index, published by Cotlook in Liverpool based on reports from correspondents in sourcing countries. Unlike the Cotlook A and B Indexes, the Yarn Index is a true index with a base year. The Cotlook Yarn Index with a base year of 2000 = 100, rose from about 100 in the early 1980s to a peak of 124 in 1994/95 and then dropped to 92 in 2001/02; the Yarn Index is about 107 in 2006/07. The Yarn Index rises and falls with the Cotlook A Index, and the correlation between weekly values of the Cotlook A Index and the Yarn Index is about 80% (see figure 1.29).

Retail prices for clothes

Another phenomenon recent to the fibre industry has been deflation in retail prices of clothing products. Data from the United States indicate that prices of clothing at retail peaked in the early 1990s and actually fell by about 8% in nominal terms from the late 1990s through 2005. Retail industry analysts suggest that reduced barriers to trade in textile and apparel products, and increased efficiency in retailing in the United States contributed to the declines in retail clothing prices. Many of the same analysts suggest that similar patterns are being repeated in Europe and Japan, and perhaps also in developing countries such as India. Regardless of the cause, the decline in prices for consumer goods is placing increased pressure on suppliers within the chain of businesses producing clothing products, including increased pressures on textile mills to reduce the costs of cotton procurement. Therefore, some analysts speculate that competition at the retail level could be contributing to declines in real prices of cotton paid to farmers.

Because of improvements in technology, competition with polyester and increased competition within the retail pipeline, one of the first points in any discussion of expectations of the future of cotton prices is that in the long term they will be lower in real terms. The Cotlook A Index averaged 55 cents per pound during the eight years between 1998/99 and 2005/06. Over the next 10 years, the average Cotlook A Index may be lower, resulting in average prices in today's dollars of between 45 cents and 55 cents per pound.

Futures markets

The Number 2 cotton contract traded in New York (ICE Futures U.S., formerly the New York Board of Trade and before that the New York Cotton Exchange) is the most widely used cotton futures contract in the world, but contracts are also traded in China (Zhengzhou Commodity Exchange – ZCE), India (National Commodity & Derivatives Exchange – NCDEX – in Mumbai) and Brazil (Bolsa de Mercadorias e Futuros – BM&F – in São Paulo). Cotton market participants operating in Brazil, as well as speculators, have access to both the New York and São Paulo markets, which is not the case in China or India. There are forward cash markets in several other countries.

The primary economic purpose of the ICE cotton futures market is to provide a forum for price discovery and a tool for price risk management. Cotton futures prices are established throughout the trading day by open outcry through the actions of many diverse market participants with a large number of competing buyers and sellers. Price quotes are transmitted worldwide. These prices reflect the latest information about supply and demand and are determined in a trading pit with the narrowest possible spread between bids and offers. The current standard cotton futures contract is for 50,000 pounds (100 bales or 22.68 tons) of strict low middling grade with 1–1/16" staple length. The contract is traded for five delivery months: March, May, July, October and December.

Detailed information on the ICE Futures U.S. and the other futures markets is presented in chapter 4.

Relationship between New York futures and the Cotlook A Index

There is no formal relationship between New York futures prices and the Cotlook A Index because there are times when United States cotton is not among the five cheapest growths quoted in order to calculate the Index. However, over time, the two price series have been highly correlated. The correlation between daily quotes for the A Index and daily closing values for the

nearby New York futures contract over the last six years has been 94%. Nevertheless, significant divergences can occur between the two price series. Since 2000, the basis between the A Index and New York Futures (the difference between the two prices) has ranged from New York being 9 cents per pound higher than the A Index to New York being 9 cents below, a relative shift of 18 cents per pound. Over the same period, the A Index itself has ranged between 29 cents per pound and 83 cents per pound, a spread of 54 cents. Consequently, the change in the basis between New York and the A Index represents one-third of the variation in futures prices, thus limiting the usefulness of the New York contract for hedging cotton from outside the United States (see figure 1.30).

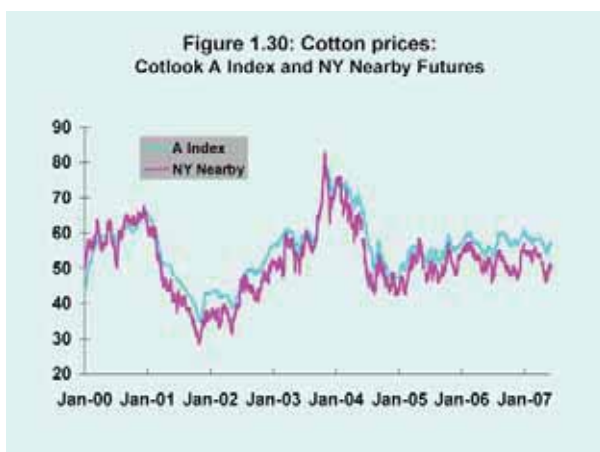

Source: ICAC.

Modeling cotton prices

ICAC uses a statistical model to relate season averages of the Cotlook A Index to a ratio of stocks-to-consumption outside China and a ratio of stocks-to-consumption in China. Prices can be predicted with about 80% accuracy, provided that cotton supply and use in China and in the rest of the world can be predicted. Experience indicates that forecasts for two years in the future are not accurate, but that price forecasts made in March and April of each year are reasonably useful for the coming season.

This statistical model is based on concepts that have been known for approximately a century. Cotton industry newsletters from before the Second World War talk about stocks and the availability of supply, and the modern econometric techniques used to quantify the relationships between supply, demand and prices were developed in the 1940s. Computers make these calculations easily today, but the basic theoretical concepts are the same as those understood a century ago.

For most commodities, prices are related to a single variable, the ratio of world ending stocks to world use. As the stocks-to-use ratio rises, prices tend to fall,

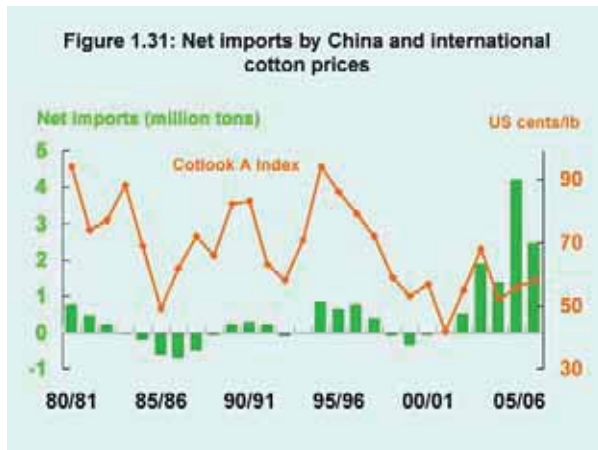

Source: ICAC.

and vice versa. However, in recent years, not only the aggregate stocks-to-use ratio has been relevant for cotton but also its geographical distribution. In particular, because of the structural changes undergone by the world cotton sector in the late 1990s, the stocks-to-use ratio in China has had a significant effect on world cotton prices. Therefore, an innovation used in the ICAC price model is that the ratio of world stocks-to-use is disaggregated into two variables: the ratio of non-China stocks-to-use and the ratio of China stocks-to-use. Arithmetically, when weighted by their corresponding regional shares of world consumption, the two ICAC variables are equivalent to the world ending stocks-to-use ratio (see figure 1.31).

In general, or as a simple rule of thumb, other things being equal, a 1% increase in the stocks-to-use ratio in China results in a decline of about one-third of a percentage point in the season average Cotlook A Index. Similarly, a 1% increase in the non-China stocks-to-use ratio results roughly in a 1.4% decline in the season average Cotlook A Index. This model explains about 80% of the year-to-year variation in average cotton prices, meaning that even if supply and use statistics were known perfectly, there could still be errors between forecasts and actual average prices of about 20%.

Sources of price forecast error

There are two sources of error in any statistical modelling exercise: the model itself and the variables used in the model. The ICAC model is statistically unbiased, meaning that the model itself does not tend to over-predict or under-predict. At the end of each season, when supply, use and trade statistics are known, the mean absolute difference between the predicted and the observed season average Cotlook A Index is about 4 cents, and the residuals of the model are random (see figure 1.32).

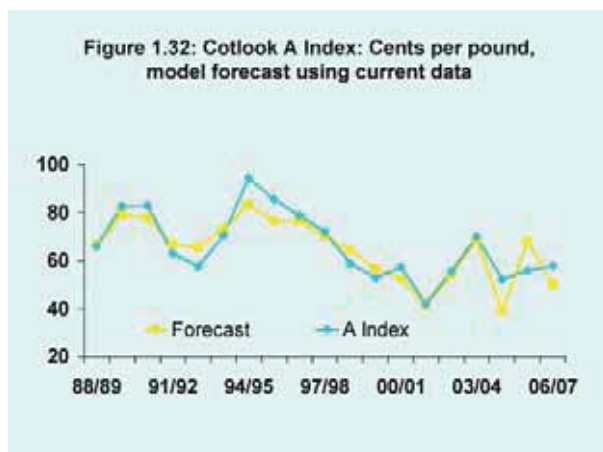

Source: ICAC.

The second source of error is the statistics that are used in the model, and this is the greater source of forecast error for cotton and for most commodities. The biggest problem for ICAC has been forecasting the ratio of China stocks-to-use. However, forecasts are highly linearly correlated to the observed stocks-to-use ratio for China and the rest of the world.

In evaluating price-forecasting techniques for cotton, it is important to realize what is not included and what is not possible.

- The ICAC price model does not explicitly include non-cotton market variables such as macroeconomic indicators and competing crop prices. Interest rates, inflation, prices of energy, GDP growth, the prices of competing crops such as wheat, soybeans, sugar and rice, and other variables affect the cotton market. However, those macroeconomic and cross-commodity impacts are linked to changes in prices of cotton through their impacts on cotton production and consumption. Therefore, ICAC considers GDP growth when estimating consumption, and soybean prices are considered when estimating production in Brazil for instance. To the

extent that cotton supply and use are estimated correctly, the likely impacts on cotton prices of macroeconomic indicators and competing crop prices can be anticipated, but they are not explicitly included in the price model.

- ❑ The ICAC price model does not acknowledge technical chart patterns, price cycles, random walk variables or lagged dependent variables as valid predictors of future cotton prices. Such models are often developed by mathematicians to predict future commodity prices based on patterns in past prices. Innumerable examples of correlations and patterns in prices can be proven after the fact. Since such models have limited foundation in theory and are of no use in explaining fundamental changes in cotton supply and use and their impacts on prices, they are not relevant to ICAC's objective of providing greater transparency to the world cotton market. ICAC is not aware of any mathematical price model that can correctly forecast price changes any better than models based on market fundamentals.
- ❑ The ICAC price model cannot be adapted to predict monthly or quarterly prices. The model is estimated based on annual data, and efforts to develop explanatory variables for a quarterly or monthly model have not yielded useful results. When the annual model indicates a season average price above the current price in any season, it is valid to infer that market forces will tend to cause prices to rise over the coming months, but the pattern of monthly price movements cannot be predicted solely with the annual model.

Expectations of accuracy

Accuracy in cotton price forecasting depends crucially on accuracy in forecasts of supply, use and trade. Therefore, improvements in forecasts of annual average prices will depend on improvements in forecasts of supply, use and trade, particularly for China.

Structural changes can occur in the cotton market that require modifications to the price model itself. For instance, in the early 1990s, the breakup of the Soviet Union led to surges in exports from Central Asian countries of cotton previously held in a State reserve, with many of the exports moving under barter arrangements. The ICAC price model was modified to include a variable for barter sales for several seasons until barter sales were essentially discontinued. Price modelling is not a one-time exercise, and ICAC routinely re-estimates the model to update coefficients and test potential variables.

Given that price forecasts tend to be wrong, it is reasonable to wonder what the value in making forecasts is. Price forecasts are accurate reflections of fundamental market conditions at the time they are made. By providing an explicit price forecast based on current best information available about likely supply and use, each price forecast serves as a valid indicator of where prices would tend if current information were correct.

The Cotlook Indices

A brief description

In 1966, the forerunner of what is now the Cotlook A Index was created, in order to address a simple question: what is the world price of cotton and how can its fluctuation be measured? New York futures was then, and remains to this day, an extremely important price indicator and instrument of price

discovery. However, only United States cotton can be delivered against the New York futures contract – hence the desire to establish a global price indicator that could take account of the prices of non-United States cottons.

The method of calculating the Cotlook A Index is simple and transparent. The quotations are based on the concept of the representative, competitive offering price for a ‘basket’ of cottons most commonly traded internationally. Those quotations refer to a common quality, contractual and geographical basis. The Index on a given day is the average of the cheapest five quotations from the selection. This has proved an effective way of identifying those growths that are the most competitive, and thus most representative of the market (see figure 1.33).

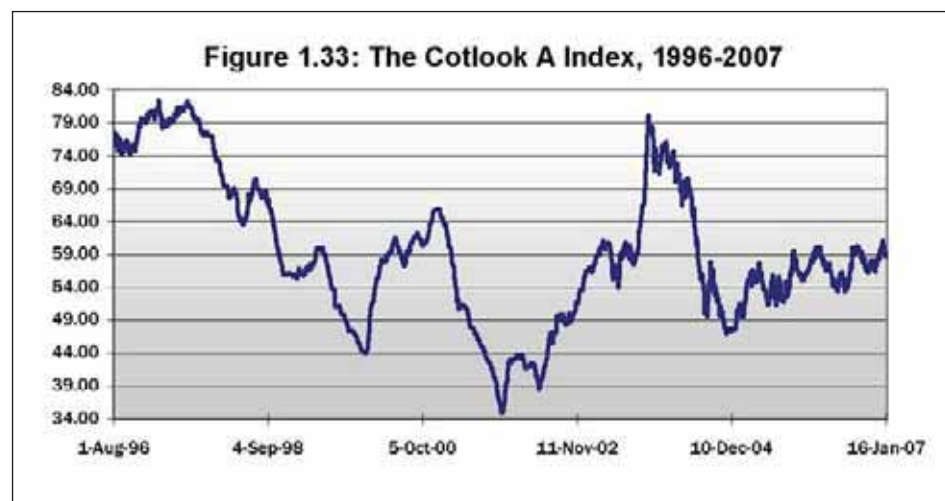

Source: Cotlook.

The base quality of the A Index is middling 1–3/32". The terms quoted are cost and freight, payment by letter of credit at sight, and including 1% agent's commission. Since 1 August 2004, the geographical basis of the quotations used in the A Index has been the Far East. The destinations taken into consideration include all of the major ports for which no significant freight surcharges exist.

The Cotlook A (NE) Index and the Cotlook B (NE) Index continue to employ the former geographical basis, North Europe. The terms quoted are cost, insurance and freight (CIF). The B Index (introduced in 1972) refers to quotations for cottons typically used for spinning coarse count yarns.

Daily quotations

The indices are published in the weekly Cotton Outlook magazine, and in Cotlook's various daily information services, available from the company's website at www.cotlook.com. Offering prices are monitored each United Kingdom business day and are published, together with the day's indices, at about 2.30 p.m. United Kingdom time. The prices are set by the editorial staff, who have no trading involvement or interest of any kind. Cotlook Ltd is an entirely independent, private company, with no external shareholders.

The Cotlook Indices are calculated from the prices at which cotton is offered to the final consumers, i.e. mills. Cotlook indicates a representative quotation for each component of each index. When cotton from any origin among the constituents is being traded freely, the Cotlook quotation will be closer to the traded value than when supply is short or in few hands. If evidence of offers is

slim, a component may be denoted as ‘nominal’ or withdrawn. It is from these daily quotations that the average values are calculated; these are the Cotlook A and Cotlook A (NE) and Cotlook B (NE) Indices.

Since the quotations are intended to reflect the competitive level of offering prices, not the level at which business has been arranged, a mill buyer would normally expect to succeed with bids that were slightly lower.

The Cotlook A Index

The Cotlook A Index is calculated by taking a simple average of the day’s cheapest five quotations (with the proviso that only two CFA zone origins may figure in the A Index calculation on any day). Eighteen growths are currently in the selection for the 2006/2007 A Index:

Memphis/Eastern	Uzbekistan	Greek
California/Arizona	Paraguayan	Australian
Memphis/Orleans/Texas	Pakistan Type 1503	Mexican
Tanzanian Type 1 SG	Ivory Coast BEMA	Syrian
Turkish S. Eastern Std 1 RG	Burkina Faso RUDY	Brazilian
Indian H-4/MECH-1/BUNNY	Benin BELA	Mali ROKY/KATY

The Cotlook A (NE) Index is for cotton classed as middling 1–3/32", and is calculated by taking a simple average of the day’s cheapest five quotations. Fifteen growths are currently in the selection for the A (NE) Index:

Memphis/Eastern	Uzbekistan	Greek
California/Arizona	Paraguayan	Australian
Tanzanian Type 2 RG	Pakistan 1503	Syrian
Turkish S. Eastern Std 1 RG	African ‘Franc Zone’	Brazilian
Indian H-4/MECH-1	Spanish	Chinese 328

The Cotlook B (NE) Index is for ‘coarse count’ cotton – that commonly used for the production of coarse count yarn. It is calculated as a simple average of the day’s cheapest three quotations for the following nine growths now in the selection:

Orleans/Texas SLM 1-1/32"	Uzbekistan
Argentine Grade C-3/4	Chinese Type 527
Brazilian SLM 1-1/16"	Pakistan AFZAL 1-1/32"
Turkish S. Eastern Std 2 RG 1-1/16"	Indian J-34
Syrian SLM 1-1/16"	

Growths are occasionally added to or withdrawn from the selections, following the provision of appropriate notice of Cotlook’s intentions, as the quality and availability of cotton from the various countries change.

Transition to an Asian (Far Eastern) basis

The change of emphasis to an Asian geographical basis was a logical progression from the long-established, European-based A Index. The change reflects the accelerating change in cotton trade flows since China’s accession to WTO in 2001. Asia (in particular China) represents the lion’s share of global raw cotton consumption and imports, whereas spinning activity has declined steadily in Europe, to the extent that the future sustainability of the North European indices must now be in doubt.

The quality basis of the A Index and the A (NE) Index is identical, namely middling 1-3/32", since this permits the widest possible selection of growths to be monitored. A higher quality base would exclude certain growths that are of importance to mills and would represent too small a section of the market.

In April 2007, Cotlook announced that the North European indices would be discontinued at the end of the 2007/08 season (31 July 2008), leaving the A Index (based C/F Asian values) as the sole indicator of world prices.

The dual system

In arithmetical terms, the manner in the indices are calculated has remained unaltered since their introduction: each is a simple average of the cheapest growths (five in the case of the A Index and A (NE) Index, three in the case of the B Index) in its respective selection.

However, since 1988, Cotlook has operated a dual index system. Under this system, two sets of indices (one reflecting quotations of the current season, the other forward quotations, for the next season) run concurrently from the establishment of the forward indices until the end of the marketing season in question on the last business day of July. At that time, the existing current indices disappear, and the forward indices are transformed into the new current indices. Those indices alone will be published until early the following year.

As soon after the turn of the year as is practicable, a forward value is established for each growth, for shipment no earlier than October/November of the coming cotton season. In deciding when to introduce each forward quotation, Cotlook is influenced only by the market evidence available, and the degree of confidence that can therefore be placed on its validity. When sufficient forward values have been introduced, they are consolidated into the A, A (NE) and B (NE) Indices. No specific date is set for this step. Forward indices are usually introduced in March, but occasionally as early as February and, in the case of the B Index, as late as July. October/November (rather than August/September) is chosen as the initial shipment period, since it is during these months that the Northern Belt crops begin to move in volume. Southern Belt new crop values are ignored for index calculation purposes before 1 January, whether they appear on Cotlook's price lists or not (see figure 1.34).

Figure 1.34: Dual index system

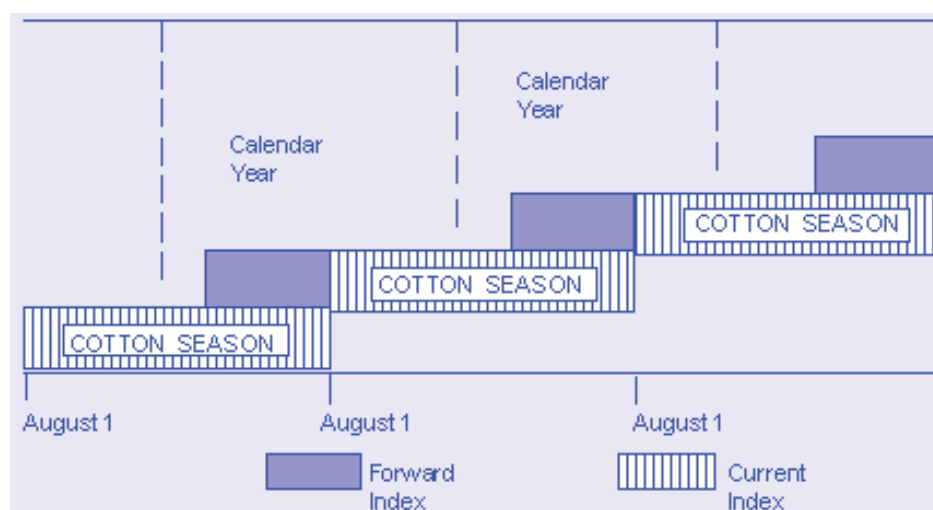

Source: Cotlook.

Uses of the Cotlook Indices

The value of the Cotlook Indices as a 'proxy' for the world price of cotton, and their transparency and reliability over several decades, mean that today they occupy an important place within the world cotton market. ICAC uses the

indices in its price forecasting and economic analysis. Several major producing countries use them either as an element of the domestic support arrangements, or as part of their export marketing systems. In the United States, the Cotlook (NE) Index is the basis for the adjusted world price, which is a key element in the marketing loan component of the United States Cotton Programme.

Cotton in the Doha Development Agenda

In June 2003 (one and a half years after the launch of the Doha Round), the Sectoral Initiative on Cotton (Cotton Initiative) was proposed by the Cotton-4 (Benin, Burkina Faso, Chad and Mali), for resolution in the negotiations. The cotton proposal has become representative of the complex trade and development challenges in the Doha Round. Progress achieved, so far, in the WTO response to the cotton proposal, has shown the possibilities and limitations of this trade/development model in a rules-based organization like WTO. Useful lessons have also been drawn from the delivery of development assistance directly linked to a negotiating mandate.

The Cotton Initiative established a connection between the low and declining price of cotton in the global market and developed country trade-distorting subsidies – a trade factor.¹ The proponents also argued that the decline of cotton export revenues had adversely affected the sustainability of their poverty reduction programmes, rural welfare, livelihood security, employment and food security. In consideration of the trade and development factors, WTO Members agreed on 1 August 2004 to address the cotton dossier on the two tracks of trade and development. Independent of the trade and development tracks in the Doha Development Agenda (DDA), a third, legal, track emerged with the case brought by Brazil against the United States in United States – Subsidies on Upland Cotton. The cotton issue is, therefore, being addressed in the DDA on the two tracks of trade and development; and also systemically, in the autonomous legal track of the WTO Dispute Settlement Understanding (DSU).

The dual trade/development model for the treatment of cotton in the DDA is a first. Never previously in the multilateral trading system had WTO Members decided to distinguish between the trade and the development policy aspects of a commodity, and then link them both by a specific coherence mandate within the framework of negotiations.² In the 1 August 2004 General Council Decision, WTO Members instructed the WTO Secretariat to work with the development community to ‘effectively direct existing programmes and any additional resources towards the development of the economies where cotton has vital importance’. The WTO Director-General was given a lead role in the process of implementation and coordinating the mandate for cotton development assistance.

Distinguished from the development assistance aspects are the trade policy aspects. The General Council placed the latter within the framework of the agriculture negotiations, under the Single Undertaking. Pursuant to this mandate, WTO Members agreed to address the trade-related aspects of the Cotton Initiative ‘ambitiously, expeditiously and specifically’, within the agriculture negotiations, in relation to all trade-distorting policies affecting the sector on all three pillars of market access, domestic support and export competition.

1 Several analyses demonstrate that, in addition to the trade factor, a complex set of factors affect global cotton prices. These include, but are not limited to, changes in technology, extensive productivity gains, price competition from chemical fibres and exchange rate movements.

2 WT/L/579, 1 August 2004 General Council Decision, Annex A, para. 5.

Members agreed to pursue coherence between the trade and the development aspects. This clarity of commitment in the mandates in relation to a specific commodity in the agriculture sector is unique. The mandates were reaffirmed by WTO Members in the 2005 Hong Kong Ministerial Declaration.

Progress on these mandates has evolved along process, institutional, operational and negotiating lines. Institutionally, the Director-General established the 'Director-General's Consultative Framework Mechanism on Cotton'. This mechanism for cotton development assistance began to function in October 2004. It is the forum for exchange of information; submission of requests in parallel with their in-country submission; notification of activities by the development community; reports on domestic reform by the recipients; and dialogue and exchange of views between donors and recipients. On the trade side, in November 2004 (a month later), the Sub-Committee on Cotton (SCC) was established to prioritize cotton independently from other sectoral initiatives. SCC adopted a work programme in March 2005. Its work is focused on assessing the negotiations in the Committee of Agriculture Special Session (CoA SS).

In the negotiations, progress has been made on the trade policy aspects, although much of it is conditional on the conclusion of the Doha Round. At the 2005 Hong Kong Ministerial Conference, Ministers agreed that:

- All forms of export subsidies for cotton would be eliminated by developed countries in 2006.
- Developed countries would provide duty-free and quota-free (DFQF) access for cotton exports from least-developed countries (LDCs) from the start of the implementation period for the agreed reform in agriculture.
- Trade-distorting domestic support for cotton production would be reduced 'more ambitiously than for whatever agreed general formula to be implemented, and over a shorter period of time than generally applicable'.

Benefiting from the progress made on the trade policy aspects depends on the conclusion of the Doha Round.

Considerable progress has been made on the development aspect, although challenges remain. In response to the mandate, action has evolved along several interrelated lines.

At the start, the development community moved to design cotton development assistance programmes and activities. Several of the proponents acted to identify cotton sector priorities. A few embarked on the process of formulating cotton sector-specific projects. As a result of donor-recipient engagement, several of the proponents intensified cotton sector and wider domestic reforms; the purpose being to enhance the absorption and maximization of assistance provided by the development community. In the ensuing exchange of views between the donor community and the recipients, specific priority areas emerged based on needs expressed by the receiving countries and areas of actual and continuing delivery. These merit attention because they are illustrative of assistance needed in a specific sector such as cotton. The areas of assistance also show overlap with areas of broader development assistance. They include:

- Support for development of national cotton sector strategies.
- Domestic, including sectoral, reform for increased competition, higher levels of efficiency and productivity.
- Trade infrastructure: roads and road transportation, railways, irrigation, warehousing, and low-cost, reliable energy.
- Rapid instrument testing technologies.

- ❑ Systems for testing, classification and labelling.
- ❑ Construction and rehabilitation of testing laboratories.
- ❑ Mechanized harvesters.
- ❑ Support for National Cotton Institutes for Training and Research.
- ❑ Support for food security, rural welfare and livelihoods.
- ❑ Specialized agricultural support and assistance in terms of cotton seed varieties, for adaptation, multiplication and disease-resistant strains, soil-management and entomology programmes, and programmes for bio-safety and training.
- ❑ Cotton capacity building in relation to reform of producer associations, support for ginning companies and training of cotton (agriculture) trade negotiators.
- ❑ Cotton Exporter's Guide and cotton trade promotion.
- ❑ Debt relief.
- ❑ Macroeconomic budgetary support.
- ❑ Market-based financial instruments to offset commodity price decline and weather risks. These include a range of possibilities, such as the Global Index Insurance Facility, expansion of commodity exchanges, agricultural price and weather risk insurance, hedge instruments, and futures and options.

This *Cotton Exporter's Guide* figures prominently in the range of assistance identified. Of equal importance, since 2004, ITC has maintained active engagement in the entire process and has contributed in no small measure to other areas of delivery. For instance, it has provided support to recipient countries seeking to prepare projects for support by the development community. These areas of assistance are reflected in the 'Evolving Working Table on Cotton Development Assistance' designed by the Director-General in 2005.³

The Evolving Table is divided into three parts. Part I covers development assistance specific to cotton. Part II encompasses assistance for cotton provided within the overall framework of 'Agriculture and Infrastructure-Related Assistance'. Part III identifies available resources that can be accessed for the cotton sector if the eligible recipient country identifies the sector as a priority and explicitly decides to allocate a specified amount of the available resources to the cotton sector.

The Evolving Table presented the concrete basis for the Periodic Report to Ministers at the Hong Kong Ministerial Conference in 2005. The Table has also emerged as the basis for monitoring. Monitoring the implementation of cotton development assistance is a critical preoccupation for both donors and recipients. The purpose of monitoring is to ensure relevant matches between identified needs and assistance on offer; bridge the gap between commitments and disbursements; gauge the pace of operational implementation; and indicate a calendar for commitments, disbursements and operational implementation. This Table is periodically updated,⁴ and is now the instrument around which the development community and the recipients of cotton development engage. It has emerged as a transparency tool, and the basis for seeking accountability and monitoring implementation. It is work in progress.

Development assistance in support of the cotton sector in DDA is no ordinary assistance. The difference from normal assistance lies in the direct linkage between development assistance for cotton and the negotiating mandate. This linkage carries the risk of different parties attempting to use either the trade

³ See WT/GC/97, 21 November 2006; pages 15–22.

⁴ See WT/L/670, 15 December 2006; WT/L/684: 5 June 2007.

policy or the development assistance aspects to leverage ‘negotiating’ objectives and positions. This has rendered the task of implementing the mandate on the development assistance aspects much more difficult.

Useful lessons have been learned in implementation. First and foremost is the vital necessity of identifying national priorities in development plans, or strategies for poverty reduction, and moving rapidly to translate priorities into professionally prepared fundable projects by the development community.

Second, the roles of the donor and the recipients are not free-standing roles, but are interlocked. One role cannot be conceived in the absence of the other. The effectiveness of one role is linked to the effectiveness of the other. And the effectiveness in the implementation of the mandate is tightly dependent on this partnership; in the absence of which the gaps between commitments and disbursements will widen and the acceleration of the pace of operational implementation will be hindered. Director-General Pascal Lamy in his periodic update to the General Council in July 2006 underscored this point when he noted that: ‘The work that had been done so far needed to be taken further, both by recipients and donors. Both had homework to do’.

Third, within the framework of multilateral trade negotiations, development assistance limited to a few Members generates sensitivities. Non-beneficiaries who are nonetheless eligible consider such limited development assistance as efforts designed to buy off and blunt trade interests. Although the initial starting point was development assistance targeted to the proponents of the sectoral initiative on cotton, the imperative for more broad-based solutions and regional activities – going beyond individual borders – emerged.

Fourth, coordination and coherence at the level of both donors and recipients remain critical, with wide scope for improvement. Development assistance has spawned dispersed and diffuse structures for identifying priorities, implementation and managing delivery. Vested interests exist and are increasing. These have an impact on efficiency in delivery. The institutional mechanism of the Director-General’s Consultative Framework Mechanism on Cotton has contributed to significantly mitigating these inefficiencies. The Evolving Table on Cotton Development Assistance remains the principal instrument for engagement, transparency and monitoring. Because of progress made in this ongoing process, the mechanism of the Consultative Framework and the instrument of the Evolving Table could be beneficial, if extended to similar areas of capacity building.

Fifth, an interactive donor/recipient process of verification is necessary for ‘notified commitments’ and ‘declared programmes of assistance’ on the part of donors, and for sectoral and wider domestic reform reported on the part of recipients. This interactive process of verification, though difficult at first, builds mutual confidence, enhances ownership, and contributes to agreed parameters for benchmarking progress. The process also fosters the principles of aid effectiveness. We have learned that banking on one-sided declarations has strong limitations and does not engender ownership. Entries into databases that record development assistance linked to a negotiating mandate indispensably require fact-based discussions and verification. A final lesson reaffirmed is that while needs are infinite, resources are finite. Hence, choices are required by recipients of assistance.

In March 2007, the Director-General, at the request of Members, convened a High Level Session on Cotton. The High Level Session took stock of progress so far on both the trade and the development aspects of cotton. Several broad conclusions were evident, but what stood out was the unanimous position taken by WTO Members and participants that there would be no outcome in the Doha Round without an outcome on cotton. This position underlined once again the priority attached by WTO Members to cotton in the DDA.

Chapter 2

Cotton value addition

Impact of varieties and production practices on cotton quality

The quality of cotton fibre in the bale depends on many factors including variety, weather conditions, cultural practices, harvesting and storage practices, moisture and trash content, ginning processes, and post-baling storage and handling practices. Certain quality characteristics are highly influenced by genetics, while others are determined mainly by environmental conditions, cultural practices, or by harvesting and ginning practices. Problems during any step of production or processing can cause irreversible damage to fibre quality and reduce profits for the producer as well as the segments of the textile industry including spinning, weaving, dyeing, and finishing. Fibre quality is highest the day the mature cotton boll opens. Weathering, mechanical harvesting, handling, ginning, and manufacturing can diminish the natural quality. Enormous differences exist around the world in terms of cotton production, harvesting and ginning practices.

Varieties

Fibre quality factors such as length, uniformity, micronaire, strength, short fibre content, neps and seedcoat fragments may differ dramatically for varieties grown under nearly identical conditions. Except for colour and leaf grade, differences in fibre quality characteristics as measured by the High Volume Instrument (HVI) classification system for cotton and other instruments are greater than the differences caused by ginning systems. Cotton variety also affects neps, seed coat fragments, and short fibre content more than gins. Gins do affect leaf grade more than variety, but hairy-leaf varieties generally produce less desirable leaf grades than smooth-leaf varieties. Thus, variety selection is the key to meeting fibre quality demands.

Field weathering affects most quality factors by weakening and discolouring the fibre. Fibre colour is substantially affected by weather and length of exposure to weather conditions after the bolls open. In fact, variety and excessive weathering have a far greater effect on fibre quality than do the most rigorous of gin processes.

Harvesting

About 70% of the over 100 million bales of cotton produced globally are harvested by hand. Although 40 countries harvest some cotton by machine, only three (the United States, Australia and Israel) harvest 100% by machine. Two types of mechanical harvesting equipment are used to harvest cotton: the spindle picker (see figure 2.1) and the cotton stripper harvester (see figure 2.2). The spindle picker is a selective-type harvester that uses tapered, barbed spindles to remove seed cotton from bolls. The cotton stripper is a nonselective or once-over harvester that removes not only the well-opened bolls but also the cracked and unopened bolls along with the burs and other plant parts. Plant



Figure 2.1: Typical spindle-type mechanical harvester for cotton



Figure 2.2: Typical stripper harvester for cotton

height should not exceed about 1.2 metres (4 feet) for picked cotton and about 0.9 metre (3 feet) for stripped cotton because too much foreign matter will be collected. Typically, spindle and stripper-harvested seed cotton contains about 6% and 30% plant parts, respectively.

Seed cotton storage and handling

Adequate storage facilities for seed cotton on the farm or at the gin are essential so that the cotton may be harvested quickly before weathering reduces its quality. Seed cotton may be stored in piles on the ground, or in sheds, storage houses, trailers or modules so long as it is protected from weather damage and from excessive ground moisture. Cotton modules (see figure 2.3), predominantly used in the United States, Australia, Israel and Brazil, are a freestanding stack of cotton produced by dumping harvested material into a form known as a module builder (see figure 2.4). When seed cotton is consolidated for storage, it should be in a covered storage area or covered with a high-quality tarpaulin.

Moisture content, length of storage, amount of high-moisture foreign matter, variation in moisture content throughout the stored mass, initial temperature of the seed cotton, temperature of the seed cotton during storage, weather factors during storage (temperature, relative humidity, rainfall), and protection of the seed cotton from rain and wet ground all affect seed and fibre quality during seed cotton storage. For long storage periods, moisture should be below 12%.



Figure 2.3: Typical free-standing modules of seed cotton



Figure 2.4: Spindle picker dumping into a module builder

Seed cotton moisture content during storage is the most important variable affecting seed germination and oil quality. Seed cotton moisture content should not exceed 10% for storage when the seed will be saved for planting. Oil quality can be preserved at 12% moisture content during storage.

Cotton ginning machinery

The principal function of the cotton gin is to separate lint from seed and produce the highest total monetary return for the resulting lint, seeds, etc. under the prevailing marketing conditions. These marketing quality standards most often reward cleaner cotton and a certain traditional appearance of the lint. The gin then must also be equipped to remove a large percentage of the foreign matter from the cotton that would significantly reduce the value of the ginned lint, especially if the cotton is machine harvested. A ginner must have two objectives: to produce lint of satisfactory quality for the grower's classing and market system; and to gin the cotton with minimum reduction in fibre spinning quality so that the cotton will meet the demands of its ultimate users, the spinner and the consumer. Thus, quality preservation during ginning requires the proper selection and operation of each machine that is included in a ginning system. The ginner must also consider the weight loss that occurs in the various cleaning machines. Often the weight loss to achieve higher grade results in a lower total monetary return.

Figure 2.5: Minimum machine sequence used to process clean, hand-picked cotton

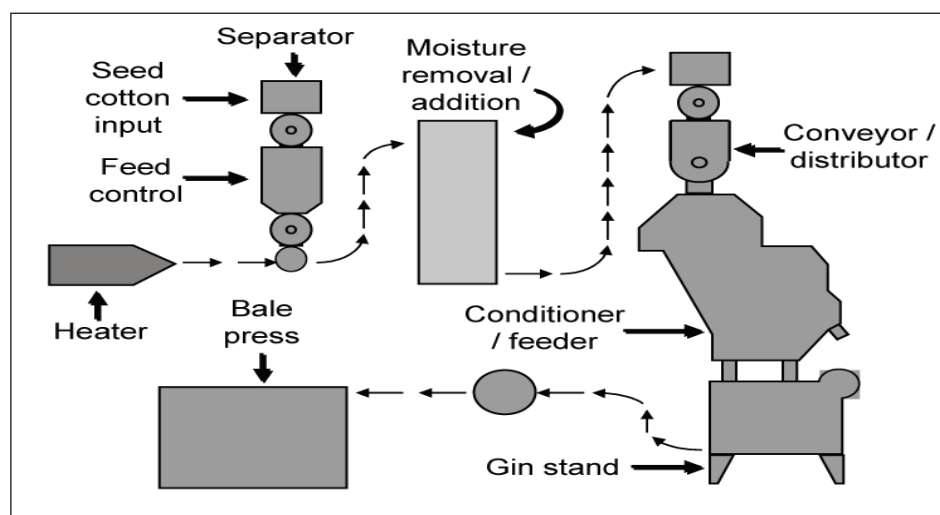

The minimum machinery required to process clean, hand-harvested cotton consists of a dryer and/or moisture restoration device followed by a feeder to uniformly meter seed cotton into a gin stand. The ginner must be able to adjust the moisture of the cotton up or down, individualize the locules of cotton, meter the locules uniformly into the gin stand to separate the fibre from the seed, and then package the fibre and seed for market. The simplified machine sequence in figure 2.5 illustrates the minimum machinery necessary to produce marketable fibre. This simplified sequence, however, does not provide versatility to properly manage cotton that has excessive moisture or trash, or cotton that must meet specialized textile needs. Since saw-type lint cleaning is not included in figure 2.5, the baled fibre will contain imperfections such as motes and trash, and will not have a smooth appearance. A more extensive machine sequence such as that shown in figure 2.6 provides the flexibility to meet almost any situation for hand- or machine-picked cotton.

Foreign matter levels in seed cotton before gin processing usually range from 1% to 5% for hand harvested, from 5% to 10% for spindle-harvested, and from 10% to 30% for stripper-harvested cottons. The level of foreign matter dictates the amount of cleaning needed.

Figure 2.6: Representative cross-sections of typical types of gin machinery arrayed in a sequence used for spindle-picked cotton

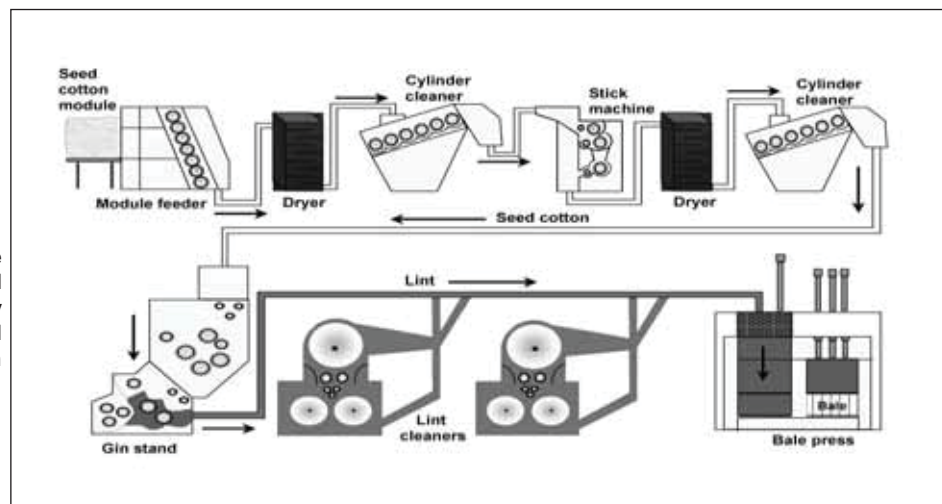

The quality of ginned lint is directly related to the quality of the cotton before ginning. High grades will result from cotton that comes from clean fields. Lower grades will result from cotton that comes from grassy, weedy fields in which poor defoliation or harvesting practices are used.

When gin machinery is used in the recommended sequence, 75%–85% of the foreign matter is usually removed from the cotton. Unfortunately, this machinery also removes small quantities of good quality cotton in the process of removing foreign matter, so the quantity of marketable cotton is reduced during cleaning. Cleaning cotton is a compromise between foreign matter level, and fibre loss and damage. Trash removal efficiency and fibre damage are inversely related to fibre moisture.

Seed cotton unloading

Unloading systems remove seed cotton from the transport vehicle and feed cotton into the gin at a constant and uniform rate. An auxiliary function is to remove rocks, metal, or other hazardous material and to remove wet, green bolls and some sand and dirt. There are two types of seed cotton unloading systems: pneumatic suction through swinging telescopes that remove cotton directly from the trailer or module; and module disperser systems that break up the module mechanically and deposit the seed cotton on to a conveyor that delivers it to a fixed suction pick-up point.

Feed control

Cotton should be steadily and uniformly metered into the gin system. This is normally accomplished by a feed control which consists of a small storage chamber as well as multiple rotating cylinders that may be manually or automatically controlled. The efficiency of the drying, cleaning and conveying systems increases as the uniformity of flow increases.

Drying

The moisture content of seed cotton is very important in the ginning process. Seed cotton with too high a moisture content will not clean or gin properly and will not easily separate into single locks but will form wads that may choke and damage gin machinery or entirely stop the ginning process. Seed cotton with too much moisture will also form tight twists known as 'fish hooks' that remain in the ginned lint and degrade appearance. Excess moisture is removed by

exposing the cotton to heated, dry air. Drying systems can seriously overdry cotton and must be used properly to avoid reducing cotton quality. Drying at low temperatures is much less harmful than drying at high temperatures.

Cotton with too low a moisture content may stick to metal surfaces as a result of static electricity generated on the fibres, and cause machinery to choke and stop. Fibre damage is especially likely at moisture contents below 5%. Dry cotton requires more force and power to compress than does moist cotton. When pressing and baling such low-moisture cotton, it is often difficult to achieve the desired bale weight and density without adding moisture.

Dryers should be adjusted to supply the gin stand with lint having a moisture content of 6%–7% to preserve fibre quality. Cotton at this moisture level is more able to withstand the stresses of ginning without breaking. However, cotton at 5% moisture content will result in better cleaning and a smoother appearance, which is erroneously preferred by many classing and marketing systems. Gin cleaners remove more trash at moisture levels below 6%–7% but not without more fibre damage. Fibre moisture higher than 7% preserves fibre length but results in ginning problems and poor cleaning.

Fibre length preservation can best be attained with fibre moisture of 6.5%–8%, but both cleaning efficiency and ginning rate are reduced at higher moistures. As a compromise, moisture contents of 6%–7% are feasible. Ginning below 5% moisture can cause serious damage to the fibres, while ginning above 8% may produce rougher lint, decreased gin capacity, and less effective cleaning. The effects of ginning cotton below 5% moisture are decreased yarn strength and yarn appearance, and increased short fibres in the card sliver.

Seed cotton cleaning

The term ‘seed cotton cleaning’ refers to the use of various types of cylinder cleaners designed primarily for removal of dirt and small pieces of leaves, bracts, and other vegetative matter, as well as ‘extractors’ that are used to remove large trash, such as burs and sticks, from the seed cotton. The cleaning and extracting system serves a dual purpose. First, large trash components such as burs, limbs, and branches must be extracted from the seed cotton before they are broken up and embedded in the cotton, and so that the gin stand will operate at peak efficiency and without excessive downtime. Second, seed cotton cleaning is often necessary to obtain optimum grades and market values, especially when ginning high-trash-content cotton. The amount of cleaning and the extracting machinery required to satisfactorily clean seed cotton varies with the trash content of the seed cotton, which depends in large measure on the method of harvest.

Gin stands

The saw gin was developed by Eli Whitney in 1793. In a gin stand, round saws rotate at a high speed between parallel metal bands called ribs. Saw gin stands typically have 12–18" (30.5–45.7 cm) diameter saws spaced 1/2–1" apart, with as many as 198 saws stacked on a single mandrel. These saws project through the ginning ribs, grasp fibre, and pull the fibre from the seed as the seeds are too large to pass through the opening in the ginning ribs. The capacity of a single gin stand has increased from less than 1 bale per hour to more than 15.

The fibre–seed attachment force varies with cotton variety, field deterioration, moisture content and other factors, but is typically about 55% of the breaking force, suggesting that the fibres can be removed from the seed without breakage. The gin stand, whether saw (see figure 2.7) or roller, pulls the fibre from the seed. It is the heart of the ginning system. The capacity of the system and the quality and potential spinning performance of the lint depend on the operating

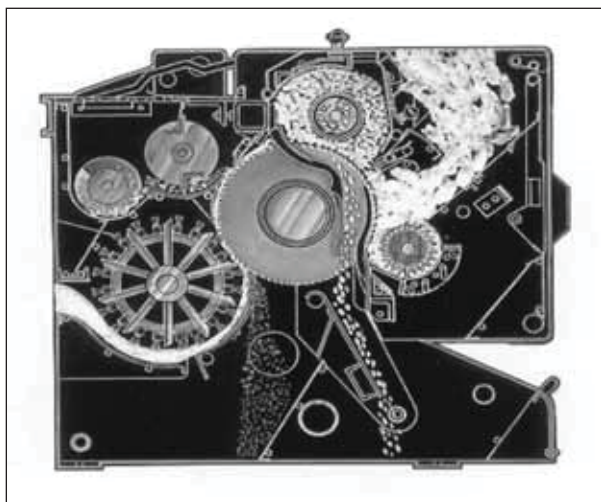

Figure 2.7: Continental Eagle 161 Golden Eagle Saw brush-type gin stand

condition and adjustment of the gin stand. Gin stands must be properly adjusted, kept in good condition, and operated at or below design capacity. If gin stands are overloaded, the quality of the cotton may be reduced. Short fibre content increases if the ginning rate increases above the manufacturer's recommendation. Short fibre also increases as saw speed increases. Increased ginning rate also increases yarn imperfections, and seed damage can result from increasing the ginning rate, especially when the seeds are dry. High ginning rate and low seed moisture cause seed damage ranging from 2% to 8% of the seed in gin stands. Thus, it is paramount to keep the gin stand in good mechanical condition, to gin at recommended moisture levels, and to not exceed the capacity of the gin stand or other components of the system.

Roller-type gins

Roller-type gins provided the first mechanically aided means of separating lint from seed. Types of roller gins include the Churka, the reciprocating knife and the rotary knife. The ginning rate of the rotary-knife gin is about 20% of the saw-ginning rate per unit of length. Seed cotton conditioning equipment in roller gins is the same type used in saw gins. Lint cleaning in current reciprocating knife roller gins is typically done with cylinder and impact cleaners similar to those used for seed cotton as well as air-jet cleaners. Roller-type gins provided the first mechanically aided means of separating extra long staple cotton lint from seed. The Churka gin, the origin of which is unknown, consisted of two hard rollers that ran together at the same surface speed, pinching the fibre from the seed and producing about two pounds of lint a day. In 1840, Fones McCarthy invented a more efficient roller gin that consisted of a leather ginning roller, a stationary knife held tightly against the roller and a reciprocating knife that pulled the seed from the lint while the lint

was held by the roller and stationary knife. A rotary-knife roller gin was developed in the United States in the late 1950s. The roller ginning process does less damage than saw ginning when separating fibre from cottonseed. However, roller ginning is a much slower process.

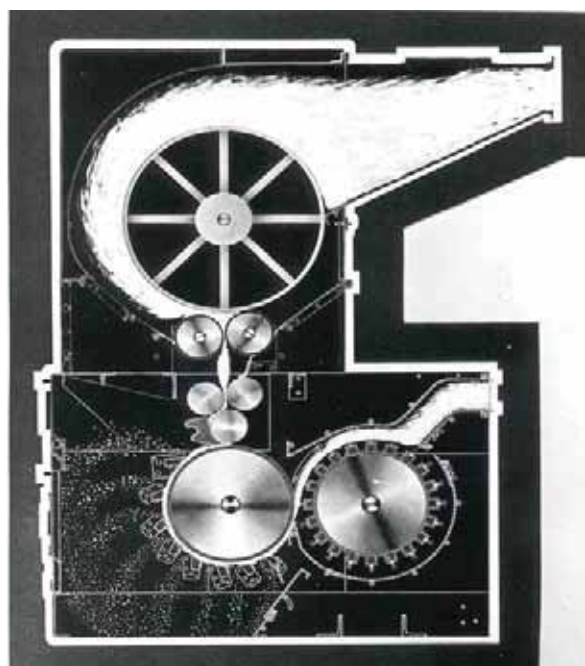

Figure 2.8: Typical saw-type lint cleaner

Lint cleaners

Lint cleaners (see figure 2.8) remove leaf particles, motes, grass, and bark that remain in cotton after seed cotton cleaning, extracting and ginning. Most gins that process machine-harvested cotton have one or more stages of lint cleaning.

Lint cleaning generally improves the grade classification (colour, leaf, and smoothness) of the lint. However, the extent of grade improvement decreases with each succeeding cleaning. Lint cleaners can also decrease the number of bales that are reduced in grade because of grass and bark content. Lint cleaners reduce bale weights and may decrease staple length, thus

affecting bale value. In some cases, the net effect of multiple stages of lint cleaning is a loss in bale sales value as well as an increase in neps and short fibre content which decreases the cotton's spinning value.

Moisture restoration

Adding moisture before fibre–seed separation and lint cleaning will help maintain fibre length and reduce the number of fibres that break in the gin stand and lint cleaners. Adding moisture to lint that has already been ginned and lint cleaned, however, will not increase fibre length. Other benefits resulting from moisture restoration include reducing the static electricity level of the cotton, reducing the volume of the cotton required to achieve a given bale size and reducing the force required to press the bale. The resilient forces exerted on the restraining bale ties are also lower when the moisture cotton is higher.

The recommended fibre moisture level of 6%–7% is based on production aspects as well as quality aspects. One approach used to restore moisture in cotton fibre is to blow humid air through the cotton to moisten it. The amount of moisture restoration with this system is limited, especially at higher ginning rates. The cotton fibres lose some of their resilience, thus reducing the compressive forces required in baling. Another approach to restoring moisture is to atomize water and spray it directly on the cotton.

Packaging lint cotton

Bale packaging is the final step in processing cotton at the gin. The packaging system consists of a battery condenser, lint slide, lint feeder, tramper, bale press, bale tying and covering systems, and bale conveyance systems. The bale press consists of a frame, one or more hydraulic rams, and a hydraulic power system. Tying subsystems may be entirely manual, semi-automated, or fully automated. Restraining ties are usually steel wire or flat, steel or plastic straps. Six to ten ties are typically spaced along the bale, but a spirally wrapped continuous tie is sometimes used. The stress on the ties after the bale is released from the press is a function of the uniformity of the lint distribution, bale weight, bale dimensions, density to which the bale was pressed, moisture content, tie length and other factors. Bale tie strength must be matched carefully to the bale press system to prevent tie breakage and subsequent contamination and handling difficulties. To prevent fibre deterioration in the bale, no portions of the packaged bale should exceed 7.5% moisture content. Fibre degradation increases dramatically as moisture content increases, especially above 9%.

Bales should be fully covered (including openings caused by sampling), and all bale covering material should be clean, in sound condition, and of sufficient strength to adequately protect the cotton. Bales are covered in natural fibres such as cotton (preferably), burlap and jute, and synthetics such as polypropylene and polyethylene. The material must not have salt or other corrosive material added, and must not contain sisal or other hard fibre or any other material that will contaminate or adversely affect cotton. For outside storage, bale coverings must include ultraviolet inhibitors commensurate with the anticipated storage period.

Effect of gin machinery on cotton quality

Good gin operations use only the amount of drying, moisture restoration and cleaning required to meet customer demands. New, proven technology must be used to process cotton as well as to monitor and control fibre quality.

The ginning process can significantly affect fibre length, uniformity, and the content of seedcoat fragments, trash, short fibres and neps. The two ginning practices that have the most effect on quality are the regulation of fibre

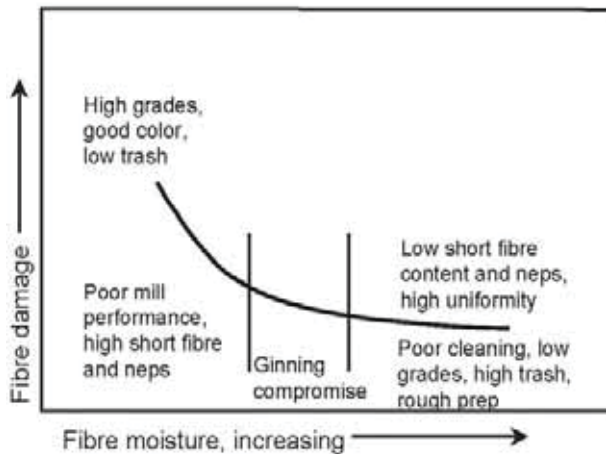

Figure 2.9: Moisture content during gin processing is a compromise between cleaning efficiency and fibre quality

moisture during ginning and cleaning, and the degree of gin cleaning used. Figure 2.9 illustrates the impact of moisture on fibre quality. The addition of seed cotton cleaning machinery affects some fibre quality parameters, and saw-type lint cleaners affect nearly all fibre quality parameters. Large and small trash particles are removed by gin machinery. Particles commonly known as 'pepper trash', which are typically about 500 microns, are dramatically reduced by all gin processes except gin stands. Saw-type lint cleaners are especially efficient at removing small trash particles.

Choosing the degree of gin cleaning is a compromise between fibre trash content and fibre quality. Lint cleaners are much more effective in reducing the lint trash content than are seed cotton cleaners, but lint cleaners can

also decrease fibre quality and reduce bale weight (turnout) by discarding some good fibre with the waste. Cleaning does little to change the true colour of the fibre, but combing the fibres and removing trash and dust changes the perceived colour. Lint cleaning can sometimes blend fibre so that fewer bales are classified as spotted or light spotted. Ginning does not affect fineness and maturity although these properties affect the amount of damage to lint during ginning and lint cleaning. Each mechanical or pneumatic device used during cleaning and ginning increases the nep content, but lint cleaners have the most pronounced influence. The number of seedcoat fragments in ginned lint is affected by the seed condition and ginning action. Yarn strength, yarn appearance and spinning-end breakage are three important spinning quality elements. All are affected by length uniformity and, therefore, by the proportion of short or broken fibres. These three elements are usually best preserved when cotton is ginned with minimum use of drying and cleaning machinery.

Compared to saw ginning, roller ginning has a higher turnout and produces lint that is longer, with fewer short fibres and neps, but contains more foreign matter and cottonseed. The roller gin process results in a lint appearance that is less smooth than that of saw-ginned lint.

The impact of cotton fibre properties on textile processing performance, quality and costs

Cotton fibre is increasingly facing competition from artificial fibres, notably polyester. Cotton, being a natural product, varies widely in its fibre characteristics, both physical and chemical (mainly physical), because of genetic, environmental, harvesting and ginning factors. There are essentially four commercially grown cotton species: medium staple length and medium fine *Gossypium hirsutum*, American Upland (which accounts for over 90% of global cotton production); long staple and fine *Gossypium barbadense*; and the short staple coarse *Gossypium arboreum* and *G. herbaceum* (together known as Desi cottons). The physical, chemical and related characteristics of cotton lint, including the type and amount of non-fibrous matter present and 'fibre configuration' (preparation, neps etc.), determine its textile processing performance and behaviour, in terms of processing waste and efficiency

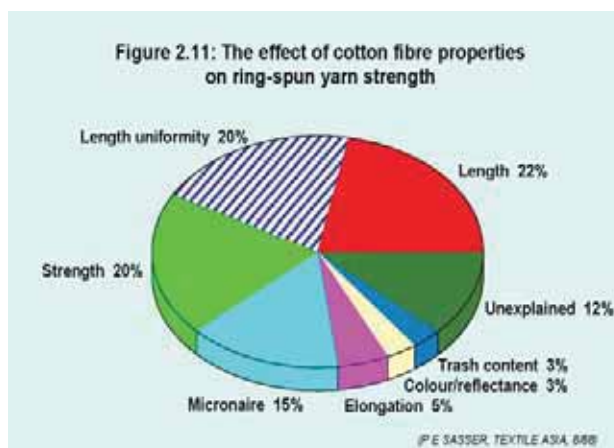
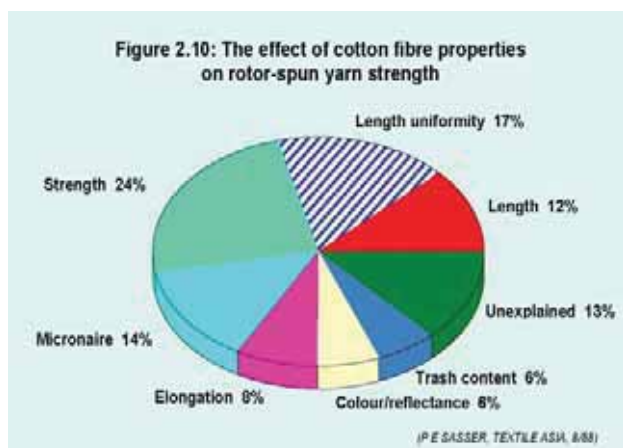

(including machine stoppages and spinning breaks) and yarn and fabric quality (see figures 2.10 and 2.11). Ultimately these characteristics also determine both conversion costs and product end-use, price and quality.

The fibre represents 50%–70% of the yarn manufacturing costs. Ideally, therefore, the price of cotton should be linked to fibre characteristics. The relationship between cotton fibre price and properties has been investigated by

Chakraborty *et al* (see figure 2.12); Deussen and Neuhaus have also advanced tables suggesting a link between cotton price and fibre properties.

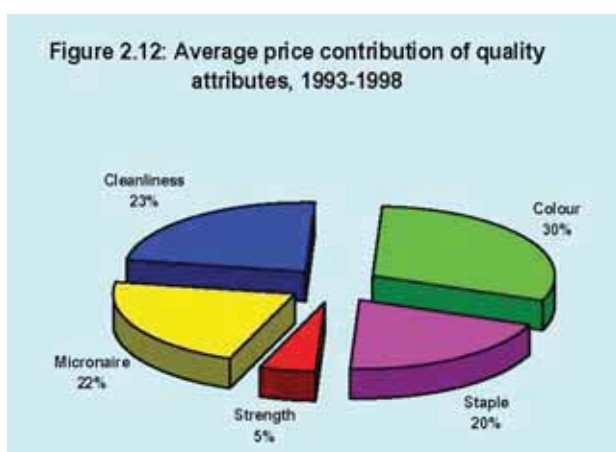

Source: Chakraborty *et al*.

Increasing quality and performance demands are being placed on the entire textile pipeline, from raw material to end-product. For example, some 20 years ago 15 non-reparable faults per 100 metres of cotton fabric were permitted, today it is 5, and this may become 3 in future. Seconds have also come down from 3% to 0.5%, with 0.3% possible in future (Weissenberger and Legler). Weaving machine stops have decreased by 50% over the same period, some 20%–30% of such stops being due to yarn defects, the repair of each end-break costing about 70 cents. It is known that thin yarn places having extension and strength below certain minimum limits cause

weaving end-breaks, such thin places and other defects in the yarn being influenced by fibre properties and spinning mill conditions.

In view of this, it is understandable that efforts are continuously being directed towards improving the desirable properties of cotton and eliminating or minimizing any undesirable properties. Such efforts are aimed at breeding, farming and ginning practices as well as at textile processing systems and conditions. Furthermore, it is hardly surprising that for over a century so much effort has gone into developing instrument methods for accurately measuring cotton fibre properties (preferably testing each bale of cotton), and quantitatively relating the measured properties to processing performance and yarn and fabric properties, so as to improve and optimize quality all-round (see box below). Tremendous progress has been made in this regard, a very good example being the development of the systems for high volume testing of cotton, commonly referred to as HVI systems. In 2006 there were some 2,000 such systems in place in over 70 countries, which, in theory, were capable of annually testing the entire global cotton crop of some 25 million tons.

Physical characteristics of cotton that can affect textile processing performance, utilization and value

Length

- *Length (e.g. UHML, 2.5% span length, ML, staple length)*
- *Length variability (e.g. CV, uniformity index/ratio)*
- *Short fibre content*

Fineness/cross section

- *Mean (e.g. mtex, micronaire)*
- *Variability (e.g. CV)*
- *Maturity (ratio between fibre wall cross section and central canal)*
- *Immature/dead fibre content*

Tensile (bundle and single fibre)

- *Mean strength*
- *Strength variability*
- *Mean elongation*
- *Elongation variability*
- *Elasticity*
- *Modulus*
- *Work-to-rupture*

Colour and dyeability

- *Yellowness (e.g. + b)*
- *Brightness (e.g. Rd)*
- *Variability in colour (spottedness, etc.)*
- *Dyeability (e.g. UV reflectance/fluorescence)*

Non-fibrous content/contaminants

- *Plant matter/trash*
- *Mineral matter (e.g. sand and dust)*
- *Organic matter (e.g. wax)*
- *Foreign fibres (e.g. polypropylene)*
- *Honeydew/stickiness/reducing sugars*

Faults/flaws

- *Fibrous neps*
- *Seed coat neps*
- *Preparation*

Crimp/undulations/convolutions/bulk

Friction

In spite of the extensive research (experimental and theoretical) carried out to relate the measured characteristics of cotton to processing performance and yarn quality, no 'generic' relationships, or other empirical or theoretical means are as yet available to accurately relate cotton fibre properties to subsequent textile performance. The reasons for this include the tremendous variations in cotton fibre properties and their interrelationships, as well as variations in processing conditions, and the interactions between processing conditions and fibre properties. The relative importance of the fibre properties also depends on the spinning system (see table 2.1), on whether or not the cotton is combed, and on the fineness of the yarn being spun.

Order of importance	Ring	Rotor (open-end)	Air-jet	Friction
1	Length and length uniformity	Strength	Fineness	Friction
2	Strength	Fineness	Cleanliness*	Strength
3	Fineness	Length and length uniformity	Strength	Fineness
4		Cleanliness*	Length and length uniformity	Length and length uniformity
5			Friction	Cleanliness*

* Absence of trash, dust, etc. (Deussen, H.)

This chapter briefly discusses the measurement of fibre properties and the impact of changes in fibre properties on textile processing performance, quality and costs. Nevertheless, the cost implications of changes in fibre properties are complex, being not only highly mill and product dependent but also difficult to isolate and quantify, even within a mill. For example, how does one calculate the cost implications of a deterioration in yarn evenness due to a decrease in cotton fibre length or an increase in short fibre content? Another example is the cost implications of an increase in cotton waste due to an increase in short fibre content, taking into consideration the recycling and/or selling of waste. It has been estimated that an increase of 1% in carding waste and in blowroom waste increases yarn costs by about 1%, while an increase of 1% each in blowroom, carding, combing and spinning waste can increase yarn costs by over 3%. Because of these complexities, the cost implications of changes in fibre properties will only be touched upon.

The measurement and effect of cotton fibre properties

The initial cotton fibre instrument measurement (laboratory) systems, developed during the first half of the twentieth century (e.g. Pressley tester in the early 1940s and the Stelometer and Colorimeter in the early 1950s), tended to be time consuming and to be fairly operator-dependent, and it was increasingly realized systems were needed, preferably automatic or even online, in which all relevant fibre characteristics could be measured accurately, rapidly and cost effectively, with little operator involvement. Nevertheless, it took many decades before this goal was reached. A major step in this direction was the development of the High Volume Instrument (HVI). From its development in the late 1960s, commercial introduction in the late 1970s and first use for cotton classing in the early 1980s, the high volume testing of cotton has made enormous strides and has become widely accepted globally. Despite certain shortcomings, it remains the only method for the wide-scale and cost-effective testing and classing of the global cotton crop.

The latest generations of high volume testing systems can test for all the traditional HVI measured properties, plus short fibre content, neps, seed coat neps, stickiness, maturity and moisture content as well as additional colour parameters (separately from those of trash and other contaminants). In some cases, however, such detailed testing is accompanied by a loss in testing speed and further improvements are still required, particularly in terms of the measurement and characterisation of trash. It can safely be said that the lint characteristics routinely measured by high volume systems today account for the bulk, but not all, of the variations in the textile processing behaviour and yarn quality of cotton. Nevertheless, the accuracy and reproducibility of the test results for some of the properties described above have not as yet achieved the levels required by industry. Under the auspices of the International Cotton Advisory Committee (ICAC), Washington, DC, a Task Force was installed in 2003 to facilitate standardized and harmonized test results for commercial use of high volume testing: the ICAC Task Force on Commercial Standardization

of Instrument Testing of Cotton (CSITC). One main objective of the CSITC is the installation of a CSITC Round Trial system. With this system three aims can be achieved:

- ❑ Evaluation of the high volume test methods and the test result variability
 - Inter-laboratory variability;
 - In-laboratory variability.
- ❑ Evaluation/rating of the participating laboratories based on the trueness of the results.
- ❑ Detailed analysis of laboratory results to achieve more accurate results based on trueness and precision.

The Round Trial system was installed in 2007, and every testing facility is invited to participate.

The first aim will help to assess the suitability of the properties tested with high volume systems. With the second aim a certification scheme for laboratories is given, although there are no “pass/fail” criteria, but a grading of the overall results. Each testing facility will be able to proof its qualification for testing with the certificate based on the rating. The third aim will help the laboratories to achieve more reliable results.

ICAC is hosting the CSITC Round Trials, which are conducted in cooperation between the United States Department of Agriculture (USDA-AMS) and the Bremen Fibre Institute (FIBRE). Information is given and registration is possible on the ICAC web pages (www.icac.org) or by e-mail (csitcsecretariat@icac.org).

The ultimate aim is to be able to measure once only, in an accurate, routine, rapid and cost-effective manner, all those cotton characteristics (see box on page 44) that play a role, however small, in determining processing route and performance, product quality, utilisation and application and ultimately the commercial value, and then to be able to quantitatively relate these properties to the subsequent textile processing performance, utilization and quality, on a mill-specific basis. The results so generated should accompany the bale until it reaches its final destination.

Another important and popular development relates to rapid, individualized fibre measurement systems for cotton (e.g. electro-optical systems, such as AFIS – Advanced Fibre Information System), enabling the accurate and detailed laboratory measurement of properties such as length (including short fibre content), neps (fibrous as well as seed coat), trash, dust, fineness and maturity (also immature fibre content, $\ominus < 0.25$), and their respective distributions. In 2006 there were some 800 AFIS systems in place worldwide. The advantage of such systems is that they supply more detailed information, even down to the individual fibre level, also covering properties presently not measured by high volume systems. The main drawback of these systems, in terms of the routine high volume testing of cotton for classing and trading purposes, is their relative slowness, although higher speed systems are slowly making their appearance.

The application of NIR (near infra-red), and other parts of the electromagnetic spectrum, for measuring certain cotton properties (e.g. maturity, stickiness and moisture content) also represents a potentially promising field of research. Such measurement systems, being non-contact and non-destructive, lend themselves to online applications, as well as to being extremely rapid and versatile.

Micronaire

The importance of micronaire, which is determined by genetic (cotton variety) and environmental conditions, was recognized early, and it was also one of the first cotton fibre properties measured by instrument using the airflow principle.

Micronaire is generally used as a measure of maturity, which is true for a specific cotton variety (cultivar) and region. Nevertheless, more generically speaking, it is a function of both maturity and fineness, which affect textile processing and quality independently and differently. It is therefore important, particularly when different cotton varieties and growing regions are involved, to measure maturity and fineness separately, and these will be discussed separately below. Nevertheless, some research has indicated that, for Upland cottons, micronaire is as good as, if not better than, maturity in predicting yarn quality and dyeability. Chellamani *et al*, for example, found the following relationship between colour difference (ΔE) and difference in micronaire and immature fibre content:

$$\frac{1}{\Delta E} = 2.064 - 0.552 (\text{micronaire difference}) - 0.025 \times \text{immature fibre content}$$

Where micronaire alone is measured, its importance lies in the fact that it affects processing waste (lower micronaire fibres break more easily during mechanical action), neps (lower micronaire fibres are generally more flexible and entangle more easily to form neps), short fibre content, spinning performance, yarn and fabric quality, dyed fabric appearance and neppiness in particular. Lower micronaire cottons also tend to become more easily entangled around particles of trash and leaf, thereby increasing the amount of good fibre removed. These features affect processing performance, and product quality and costs. Lower micronaire cottons also need to be carded slower. Neps can interfere with drafting, resulting in end-breakages during spinning. If micronaire levels within a lay-down or mix vary unduly (by more than 0.2 units), it could lead to streakiness or barré because of differences in dye shade. It is generally considered that both too-low and too-high micronaire cottons should be avoided, the ideal range being between about 3.8 and 4.2 for American Upland type cotton. Nevertheless, micronaire values below 3.8 would be preferable provided the cotton is mature, particularly for rotor spinning.

Maturity

Maturity, which is largely determined by growing conditions, can be defined as the relative wall thickness (i.e. the area of the cell wall to that of a circle with the same perimeter as the fibre, or the ratio of the cell wall thickness to the overall 'diameter' of the fibre). Cross sections of fibres of different maturity are shown in figure 2.13.

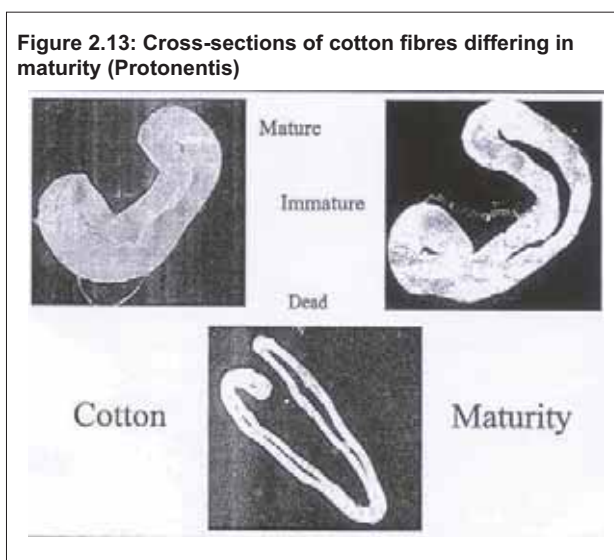

Maturity generally has a greater effect on fabric appearance and defects than any of the other fibre properties. It is commonly measured by the double compression airflow test, although single fibre measurements (e.g. AFIS) are used for more detailed information, including maturity distribution and the presence of immature and dead fibres. Different means of expressing maturity are in use, the two most popular being the percentage maturity (Pm) and maturity ratio (M), a level of at least 0.9 (preferably 0.95) for M and 80% for Pm being desirable. Cotton fibre maturity greatly affects nep formation, dye uptake and dyed appearance. Variations in maturity within a yarn batch or fabric can lead to streakiness and

barré because of differences in dyed appearance. It is, however, not only the average maturity which is important but also the distribution of maturity. A small percentage of immature or 'dead' fibres may not significantly affect the average maturity but could significantly affect the yarn and fabric appearance,

notably in terms of neppiness and white flecks which can comprise only about 0.5% (by weight) of fibres. The lighter appearance of dyed immature fibres is mainly due to their flat and ribbon-like non-uniform shape and the shorter path-length the light takes through the thinner dyed wall, rather than due to a lower dye uptake, with the difference in light reflectance characteristics from the 'flat' fibre surfaces also playing a role (e.g. shining neps). Nevertheless, the rapid desorption of dye from immature fibres may also play a role. Scouring and finishing losses are also greater for immature cottons, because their non-cellulosic contents are higher. Fibre maturity also affects lustre. Immaturity can also be associated with stickiness and roller lapping because of excessive plant sugars, particularly under high humidity conditions. Combing is known to remove relatively immature and fine fibres.

Fineness

Cotton fibre fineness per se, which is determined by both genetic and environmental factors, has an effect on many aspects of processing performance, including spinning performance, and yarn and fabric quality. It is measured by double compression airflow tests as well as by single fibre 'optical' measurement systems, such as AFIS. Finer fibres, being more flexible and buckling more easily, entangle more easily to form neps, and break more easily to create more short fibres and fibrous waste, but improve spinning performance and yarn evenness and strength, mainly through the effect of the greater number of fibres in the yarn cross section, this being particularly important for very fine yarns and for rotor (open-end) and air-jet spinning systems. Spinning limits, in terms of the number of fibres in the yarn cross section, are 100 or more for rotor, friction and air-jet spinning and about half that for ring spinning. Finer fibres also enable lower roving and yarn twists to be employed, as well as being required for maximum yarn strength. Finer fibres also lead to yarns and fabrics which are more flexible (less stiff) and which have a softer handle. Fabric air-permeability is inversely related to fineness. The ideal, particularly for rotor spinning and fine yarns, is a very fine (< 150 mtex) but fully mature fibre.

Length and length uniformity

Length, length uniformity and length distribution, including short fibre content, are probably the most important cotton fibre properties, although their importance does depend somewhat on the spinning system used. Fibre length characteristics are determined by genetic (cotton variety) factors as well as by ginning and textile processing conditions, the latter in terms of fibre breakage. Cotton fibre length characteristics are probably the best criterion for ring spinning performance and spinning limits and often also of yarn strength. An increase of 1 mm in fibre length increases yarn strength by some 0.4 cN/tex or more (Frey, M). The staple length, upper half mean length (UHML) and 2.5% span length all provide similar, but not identical, measures of the length of the bulk of the long fibres in a sample, and approximate the length of the fibres when carefully detached from the seed by hand. They are measured by HVI and other similar systems, as well as by slower single fibre measurement systems, such as AFIS. These measures are useful for setting drafting roller distances, with UHML increasingly being measured by high volume systems and adopted for trading purposes. A length above 28 mm is desirable in most cases, although this depends upon the spinning system and yarn count. The mean length (ML) or 50% span length is generally regarded as providing a better measure of spinning performance and yarn quality. Longer cottons, which are often also finer, are generally more prone to forming neps during carding and are therefore often carded at lower speeds and also combed to remove neps and to even better align the fibres. Longer fibres also enable lower roving and yarn twists and higher ring spinning speeds to be employed, also producing finer, stronger, more even and less hairy yarns, as well as stronger fabrics with better appearance.

Excessive fibre length variation (e.g. CV of fibre length, uniformity ratio or uniformity index) tends to increase manufacturing waste and to adversely affect processing performance, including spinning performance and yarn quality. The inverse of length uniformity also provides a measure of floating fibres within the drafting zone, although the short fibre content (SFC) is a better indicator of the floating fibres. SFC is generally defined as the percentage, by weight, of fibres shorter than $\frac{1}{2}$ " (12.7 mm). SFC by number is, however, considered a more sensitive measure of processing conditions. Although the uniformity index is typically, and accurately, measured on high volume systems, on its own it does not provide an accurate measure of SFC. A uniformity index of above 83% and uniformity ratio above 48% are desirable, although it depends upon the spinning system and yarn count.

An increase in SFC increases spinning end breaks, processing waste (including comber noils), fly and optimum roving twist, and causes deterioration in yarn and fabric properties, notably yarn strength and evenness. An increase of 1% (absolute) in SFC can decrease ring spun yarn strength by 1% or more. Fabric strength and abrasion resistance also tend to deteriorate with an increase in SFC. Different instruments will find differences in SFC and other measures of fibre distribution. An SFC below 8% (by weight) is desirable, although the SFC level is generally a function of the staple length (UHML).

Strength

The strength of individual cotton fibres is largely determined by the fineness of the fibres, whereas the tenacity (i.e. fineness or cross section corrected strength) of cotton is largely determined genetically. Cotton fibre strength, or more correctly cotton fibre tenacity, is generally measured on fibre bundles, as opposed to single fibres, at either zero-gauge or $\frac{1}{8}$ " (3.2 mm) gauge, with the latter increasingly being measured and accepted worldwide as a better indicator of yarn and fabric strength than the former. High volume systems provide a reasonably accurate and reliable measure of cotton fibre strength. Although cottons with good strength usually give fewer problems and neps during processing than weaker cottons, cotton fibre tenacity per se does not play such an important role in processing, except probably in rotor spinning where it can improve spinning performance, particularly when spinning fine yarns. It is important to note, however, that in absolute terms (i.e. cN), finer and less mature cottons are weaker than coarser and more mature fibres, but when strength is expressed in terms of tenacity (cN/tex or gf/tex), i.e. corrected for fibre cross section or fineness, then this effect largely disappears. Finer, and therefore weaker, fibres will be more inclined to break during processing, but when converted into yarn of a constant linear density, will produce a stronger yarn because of the greater number of fibres in the yarn cross section. It is therefore always important to make a distinction between absolute fibre strength (i.e. uncorrected for cross section or fineness) and fibre tenacity (corrected for cross section or fineness). Even in terms of spinning performance, the effect of fibre strength is small, whereas fibre tenacity is virtually linearly related to yarn and fabric strength, all other factors being constant. Fibre tenacity is particularly important for rotor spinning. At optimum yarn twist, fibre tenacity has a greater effect on yarn tenacity than any other fibre property, strength utilization being typically 50%–60% for rotor yarns and 60%–70% for ring yarns, an increase in fibre strength of 1 cN/tex increasing yarn strength by some 0.5 cN/tex or more. A bundle tenacity above 30 cN/tex (HVI level) is generally desirable.

Elongation

Generally fibre elongation (extension at break) is measured at the same time as fibre strength, it being determined by genetic and environmental factors. An increase in elongation is associated with an increase in yarn and greige fabric

elongation and nep formation, the relationship between yarn elongation and fibre elongation being a function of fibre length and yarn twist and linear density. Yarn elongation significantly affects weaving efficiency. An increase in fibre elongation can sometimes reduce spinning end-breakage and yarn strength. A level above 7% is desirable.

Colour

Cotton is generally white when the boll opens, but continued exposure to weathering and micro-organisms can cause the cotton to lose its brightness and to become darker. Cotton may also become discoloured or spotted by the action of insects, fungi, plant diseases and soil stains, or when killed by frost or drought. Reducing sugars and storage under high humidity conditions can cause yellowing.

Colour has little effect on processing but affects dyeing and finishing. Bleaching is often able to reduce, or even eliminate, differences present in the raw cotton. Differences in colour after bleaching do not necessarily correlate with colour differences after dyeing.

It is important to measure not only average colour, but also colour variability, including spottedness, since this can affect processing and dyeing performance and fabric appearance. Colour is generally measured by instrument, in terms of its greyness, reflectance or brightness (Rd) and yellowness (+b), although there is a move towards CIE colour values. Trash has some effect on the measured values. Typically +b is about 9.0 and Rd 75%.

Preparation

This property, which indicates the appearance of the cotton after ginning, as a consequence of the treatment which the cotton received during harvesting and ginning, cannot, as yet, be measured by instrument. Preparation can have an effect on processing waste and yarn quality.

Figure 2.14: Fibrous neps and seed coat neps (Trützchler)

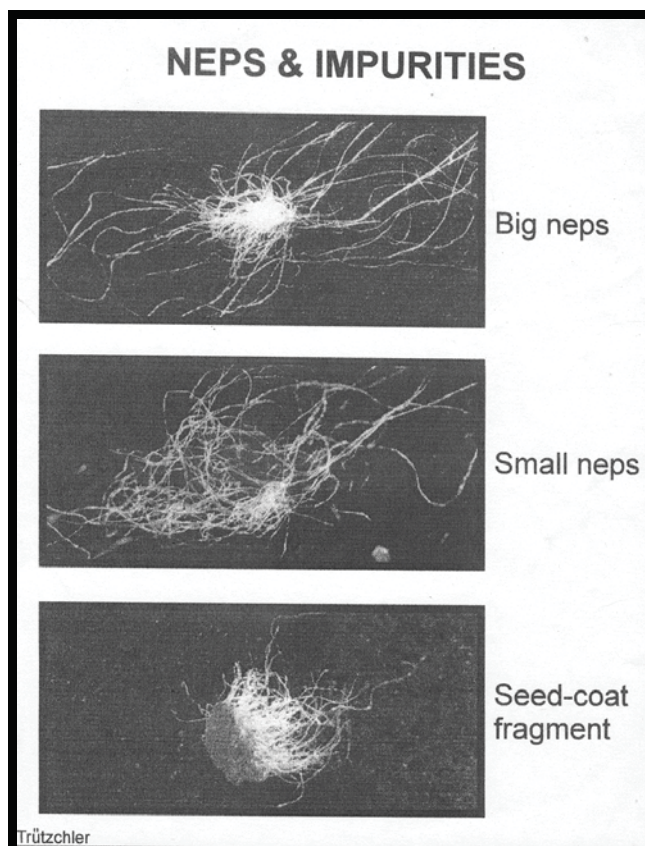

Neps

Cotton on the seed or carefully removed by hand from the seed contains very few neps. Neps consist of either an entanglement (cluster) of fibres (typically 16 fibres), with or without foreign matter (e.g. trash or seed coat fragments) as a core (see figure 2.14).

Although neps are related to fibre properties, such as maturity (including maturity distribution and 'dead' fibres), harvesting, ginning and mechanical treatment conditions in the spinning mill significantly affect nep levels. There is therefore a need for a separate test for neps. Many instruments are available to do this, but few, if any, are rapid enough for high volume classing and trading purposes. It is also important to be able to separately measure the different types of neps, e.g. seed coat neps and fibrous neps. Neps lead to yarn and fabric imperfections and unevenness, and also to spinning end-breakages. They are responsible for up to 50% of yarn imperfections, seed coat fragments being particularly problematic.

Trash (non-lint) content

Trash, often referred to as non-lint, commonly comprises fragments of leaves, bark and grass, as well as particles of sand and dust. The levels of such contaminants are determined by growing, harvesting and ginning conditions. Plastic materials also represent a serious source of contamination.

Both the type of trash and the quantity are important in determining processing behaviour and performance and waste levels. Trash content can be measured by various laboratory instruments as well as by high volume systems (although the latter do not, as yet, provide a satisfactory means of doing so), providing a measure of trash area and number (count) and leaf grade. Sophisticated systems, using image analysis and colour differentiation, have been developed to more accurately measure trash levels and type.

Trash content is directly and indirectly related to processing waste, the removal of trash being associated with fibre breakage and the removal of fibres as waste, as well as nep formation. These in turn can considerably affect spinning performance, particularly rotor spinning, and yarn quality. Air-jet and friction spinning require even lower levels of non-lint content than rotor spinning. Fabric and yarn appearance can be adversely affected by trash that is not removed during processing. Trash and dust content can have a particularly adverse effect on rotor spinning performance and yarn properties, since it causes a build-up of deposit in the rotor groove which interferes with yarn formation, and therefore causes end-breaks and reduces yarn quality. Seed coat fragments, with tenaciously clinging fibres, are an important cause of yarn faults, also adversely affecting spinning and yarn performance.

Respirable dust, or agents associated with the dust, create health problems and can lead to byssinosis. Fine particles of trash can also form the nucleus for neps. Microdust can affect the wear of spinning components, particularly in newer spinning systems such as rotor, friction and air-jet, and also clog the rotor groove and air-jet nozzles.

Foreign matter and other contaminants, such as plastic materials, can have a very harmful effect on quality, not only adversely affecting processing performance (notably spinning), but also showing up as faults in the fabric, particularly after dyeing. ITMF studies indicate that claims related to contamination amount to 1%–3% of total sales of cotton and cotton blend yarns.

Wax content

Levels of cotton wax are determined by both genetic and environmental conditions and are usually measured by solvent extraction. Cotton wax, which is mainly on the fibre surface and in the primary wall, has a beneficial effect on mechanical processing. The amount of wax per unit surface is fairly constant, and finer cottons therefore contain more wax per unit weight than do coarser cottons. Wax affects wetting behaviour and should be removed where good wetting is required, such as in towels. Such removal can beneficially affect yarn strength but adversely affect fabric crease recovery, flex abrasion and tear strength. Excessive wax can sometimes also cause problems with stickiness and roller lapping. In most cases the wax on the fibre makes it unnecessary to apply oils or lubricants to facilitate mechanical processing, but any wet treatment applied prior to processing can affect this negatively. Cotton wax enables cotton to be processed trouble-free on most systems.

Friction

Cotton fibre friction does not vary greatly, being determined by the wax, electrolytes and sugars (Gamble) present on the cotton fibre surface and pectin present in the primary cell wall (Gamble) as well as on any chemical (wet) treatments applied to the fibre. Fibre friction is important in determining mechanical processing behaviour and performance as well as yarn quality, in

particular strength (fibre-to-fibre friction). No suitable practical test for fibre friction is available. Measuring the levels of fibre surface wax and other components (e.g. by NIR), represents the best way to obtain a rapid, though indirect, measure of cotton fibre friction.

Ultra-violet fluorescence

Variations in the ultra-violet (UV) fluorescence, within and between bales of cotton, could signify potential dye variation and fabric streakiness, particularly when dyeing pastel shades. Such differences in UV fluorescence could be due to differences in ageing, weathering, contaminants, light exposure, mildew attack or heat treatment.

Dyeability

Dyeability is important, particularly in terms of streakiness and white specks. Dyeability is related to micronaire, maturity, colour and fibre structure, some 70% of yarn-related dye problems being due to the fibre. The control of the first three of these properties will largely control dyeability, although there is still a need for a rapid test for dyeability (e.g. by means of UV or NIR).

Stickiness

Sticky cotton causes roller lapping and can have a very large adverse affect on processing performance, including both ring and rotor spinning. It may be caused by excessive quantities of plant sugars on immature cotton, but about 80% of the time is caused by honeydew (a sugar-containing sap secretion from insects, such as aphids or whiteflies), by high wax levels, or even by additives or contaminants (e.g. pesticides). Cotton-seed oil, from seed-coat fragments and seed motes, could also be related to stickiness problems. Storage and low levels of humidity during processing as well as certain additives (e.g. water, enzymes, surfactants and lubricants) can reduce certain stickiness related problems. Various tests are used for measuring stickiness, including:

- Mini-card;
- Thermo-detector;
- Crush-rollers and image analysis;
- pH;
- Chemical/reducing sugar content (e.g. Clinitest, Perkins Method, Benedict Test and Fehling Tests), to provide a measure of non-honeydew related stickiness;
- HPLC;
- Discolouration upon heating.

Nevertheless, there is a need for a rapid (high volume) means of measuring stickiness, (e.g. NIR). Measurement is complicated by the 'non-uniform' and 'localized' nature of stickiness, and the low levels and different types of contaminants which can lead to stickiness problems.

Crimp and bulk

Fibre crimp (waviness or undulation), which is largely determined genetically, can be expressed in terms of crimp frequency and amplitude, as well as in terms of decrimping force and crimp extension (crimp per cent). Cotton fibres vary in crimp and bulk, but there is little evidence that the variations in crimp generally encountered have a significant effect on cotton processing performance and yarn quality. A high recovery from compression is regarded as a prerequisite for good carding.

Stiffness, elasticity, modulus and work-to-break

Often the ratio of bundle tenacity to bundle elongation is taken as a measure of stiffness. Stiffer fibres are less likely to buckle or entangle, and form fewer neps during carding. A better measure of stiffness would be the ratio between absolute fibre strength (cN) and elongation, as this would allow for the substantial effect of fibre fineness on stiffness and nep formation.

Work-to-break, elasticity and modulus can be estimated from high volume measured results, but the magnitude and importance of variations in these properties in practice still need to be established. These properties are determined by both genetic and environmental factors.

Neps and short fibres

In 2002, China announced its intention to use obscure test methods to determine the acceptability of nep levels and short fibre content in ginned cotton. China later relented on this announcement. Nevertheless, this episode did bring two facts to the forefront:

- ❑ No high-volume, repeatable measurement of either of these properties is currently available.
- ❑ The textile manufacturer treats neps and short fibres as ‘contaminants’ within the useful cotton fibres.

The inability to measure undesirable properties of fibres does not prevent the market from discriminating against them. Typically the textile manufacturers will come to the opinion that these properties are likely to be present in cotton from a particular source, and then they will avoid purchasing cotton from that source in the future. Thus, the production sector will find that it has lost access to certain markets that are sensitive to these properties. Without doubt, this does occur for cottons with elevated levels of neps or short fibres.

Nature of neps and short fibres

Neps

The general definition of neps is ‘hopelessly entangled masses of fibres’ (see figure 2.15). The appearance of common neps on yarns and fabrics is shown in figure 2.16. Neps may be further categorized into ‘seedcoat neps’ – which have a piece of the seedcoat attached to the fibres (see figure 2.17) – and ‘shiny neps’ – which consist of dead fibres, with insufficient cellulose to even absorb dye (see figure 2.18). If neps are incorporated into the yarn, it is quite likely they will survive into the fabric. Generally, if neps exceed a fairly low threshold, the resulting fabric is not suitable for high-value textile products.

A very small portion of observed neps may exist in unprocessed cotton, but the vast majority of neps are caused by handling and processing. Almost any mechanical process can cause the formation of neps, but the most likely ones include harvesting, ginning, and opening/cleaning in the textile mill. Neps are generally removed from the cotton fibres at only two places in the textile mill:

Figure 2.15: A nep in raw cotton



Source: International Textile Center.

Figure 2.16: A nep in yarn

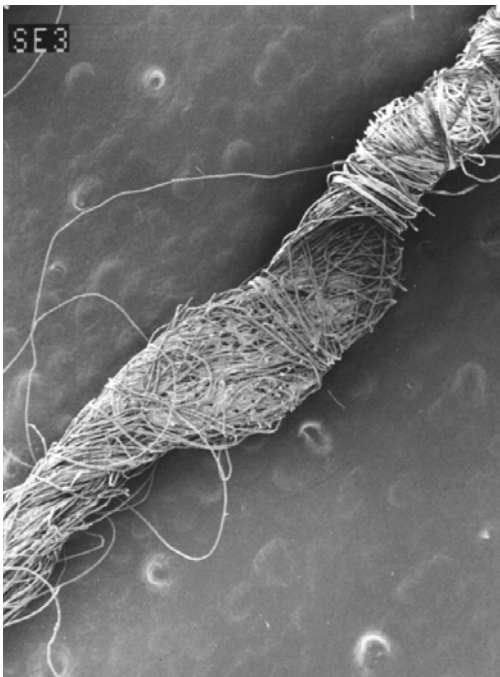

Source: International Textile Center.

Figure 2.17: A seedcoat nep in yarn

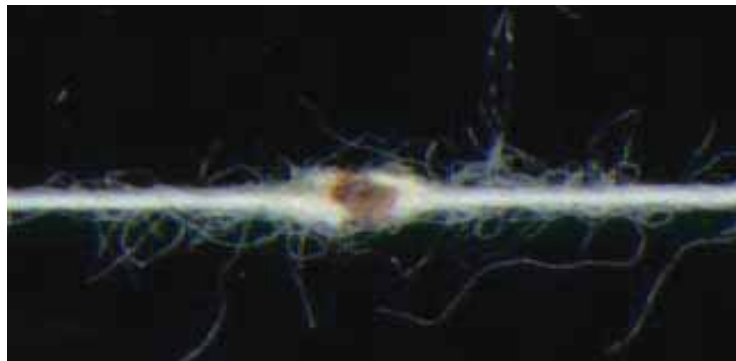

Source: International Textile Center.

Figure 2.18: White speck nep (highly magnified) attached to mature fibre



Source: International Textile Center.

the carding machine and the combing machine. If the cotton is not combed, only the carding machine is left to do the job. A state-of-the-art, well-adjusted carding machine can remove about 90% of the neps that are fed into the machine. Thus, if the cotton feeding into the carding machine has 200 neps/gram, then the count for cotton coming out in the card sliver may, in the best of circumstances, be reduced to about 20 neps/gram. And 20 neps/gram is a threshold above which the fibres' usefulness for making high-quality textile products rapidly deteriorates.

While mechanical processes are the chief cause of neps, some cotton fibres are more susceptible to nep formation than others. In other words, there are significant interaction effects between some fibre properties and mechanical processes with regard to nep formation. Susceptibility to neps tends to increase as the perimeter of the fibres decreases, the maturity of the fibres decreases, the length of the fibres increases, and with either very high or very low moisture content. Also, the more trash the cotton contains, the more the fibres must be cleaned, which will result in the formation of more neps.

Short fibres

The traditional definition of 'short fibres' is those fibres less than 1/2" long. It has long been apparent, however, that this traditional definition is inadequate. Most spinning systems can be adjusted to accommodate the 'dominant long fibre content' – which is practically synonymous with the 'staple length' – of cotton. If the staple length is quite long, then the critical designation for short fibre may be longer than 1/2". If the staple length is short, then the critical designation for short fibre may be shorter than 1/2".

Figure 2.19: Length distribution (by weight) of two cottons with similar staple length

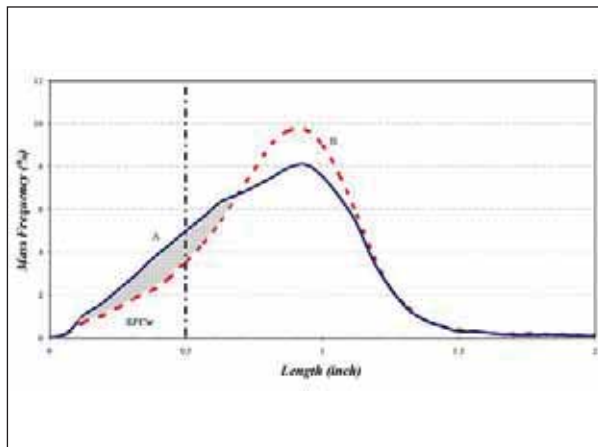

Source: International Textile Center.

Figure 2.19 shows frequency distributions for the length of two different cottons, as obtained from AFIS®. While the mean lengths of the two cottons are approximately equivalent, sample A exhibits a larger portion of shorter fibres than does sample B (as shown by the shaded area in figure 2.19). These shorter fibres are negatively correlated with good yarn properties (e.g. strength and elongation) and positively correlated with bad yarn properties (e.g. CV%, thin and thick places, and hairiness).

The critical need, after all, is information on the *entire length distribution* of the cotton being spun. There can be no doubt that, regardless of the staple length of cotton, the more uniform the length distribution is, the better the cotton will perform in spinning. Furthermore, even a slight

elevation of very short fibres (say, less than 1/4") is likely to disproportionately damage spinning performance and yarn quality. These statements apply regardless of whether the poor length distribution is caused by genetic factors or by fibre breakage in harvesting, ginning, or textile manufacturing.

It may have already occurred to the reader that there is likely to be a strong interaction effect between neps and short fibres, since in the previous section short fibres were given as one of the causes for an increased tendency toward nep formation. This is in fact true; indeed, most fibre properties that tend to elevate the number of neps also tend to elevate the number of short fibres.

- ❑ Not only do immature fibres readily tangle up to form neps; they also readily break under any kind of mechanical stress. This, in turn, fosters the creation of even more neps.
- ❑ Fibres that are long and fine are more subject to breakage in high-speed manufacturing than fibres that are short and coarse. (It is common practice to slow machinery down when processing long, fine fibres.) Elevated levels of breakage may be a primary reason that neps are manifested in long, fine fibres.
- ❑ Fibres with very low moisture levels are much more likely to break, and then are susceptible to forming neps.
- ❑ Fibres that have elevated levels of trash must be cleaned more aggressively, resulting in more broken fibres and, therefore, more neps.

Measurement of neps and short fibres

There are several 'yarn evenness' instruments widely used by the global textile industry to measure neps on yarns. These instruments typically use electro-optical sensors to detect yarn neps and to measure yarn evenness, thick and thin places, and hairiness. The incidence of short fibres cannot be directly measured using the yarn.

Modern yarn spinning mills are increasingly trying to monitor both neps and short fibres. For example, yarn quality at each spinning position is monitored by 'yarn clearers'. Also, some carding machines may be equipped with an instrument that monitors neps in the card web.

Note that while advances in online monitoring of quality are useful, the best solution to nep and short fibre problems is prevention: that is, finding ways to reduce the occurrence of these problems in the raw fibres delivered to textile mills.

The AFIS® instrument

The only commercial instrument in global use for measuring neps and short fibres in raw cotton is the Advanced Fiber Information System (AFIS®), made by Uster Technologies. It also measures other fibre properties, such as fineness, maturity, trash and dust. Since AFIS® obtains measurements on individual fibres, it can provide quantitative data on the *distributional* behavior of the cotton (see figure 2.19, for instance). As previously suggested, information on the distribution of fibre properties is much more useful than information just on the average of these properties.

While AFIS® is being successfully used within textile plants, it is neither high-volume enough nor repeatable enough for use in the cotton marketing system. However, great care with protocols for sampling and measuring make it a useful tool in:

- ❑ Breeding and biotechnology programmes aimed at developing fibres that are less susceptible to nep formation and short fibres; and
- ❑ Harvesting and ginning evaluations to reduce nep formation and fibre breakage in such processes.

While it is obvious how AFIS® may be used to evaluate the mechanical processes of harvesting and ginning, it may not be clear how it could facilitate the development of improved fibres. One way it could help is by identifying varieties that have a tendency to fibre breakage. Another way is by identifying varieties that have a higher percentage of fibres that elongate but do not mature fully. Still another possibility for use of AFIS® is to identify cotton varieties that have a genetic tendency to a higher percentage of fibres that do not elongate like the others.

Other instruments for raw cotton

The measurement of neps by image analysis of a cotton web is part of the design of the Lintronics Fiberlab®. Measurement of the fibre length distribution by image analysis is part of the design of the STI IsoTester®. Widespread testing of these instruments has not yet been done; therefore, their usefulness is not yet established.

Besides the AFIS, the measurement of the length distribution and nep content is also possible with instruments from other manufacturers, as e.g.

- ❑ The aQura, manufactured by Premier Evolvics, based on an automatic separation and detection of neps, and on the length measurement of beards, which are end-aligned automatically;
- ❑ The Lintronics Fiberlab® for the neps measurement by image analysis of a cotton web;
- ❑ The STI Iso Tester® for the length distribution measurement by image analysis.

Conclusion

Clearly, measures that are sufficiently high volume and repeatable for use in international marketing are not likely to be available soon. But existing measures can be used to improve the genetics of cotton fibres, as well as the harvesting and ginning of cotton, in order to provide the global textile industry with a raw material that contains less of these contaminants.

Extraneous contamination in cotton

Extraneous contaminants in raw cotton have become a real nightmare to spinners worldwide. Spinners have been demanding low levels of contamination in raw cotton for the last three decades but, on the contrary, contamination in raw cotton has constantly increased. ITMF surveys show a two-fold increase in total contaminants worldwide in the last 15 years, while the end-users of yarn and fabrics demand incredibly low levels of contamination. Thus, spinners are under pressure from both sides.

Contaminants present in the yarn result in huge volumes of fabrics and clothing being sold as seconds. Ultimately, the claims from the end-users are passed on to the spinners. It is quite unfortunate that the spinner is the one who is blamed for the presence of contamination in yarn, fabric and garments. Spinners pay a sizeable percentage of the total sales of their cotton and blended yarns on contamination claims, while they struggle and survive on very thin margins. Hence, they are forced to take steps to minimize the problem, even though the origin of the problem is elsewhere.

Spinners are compelled to make huge investments in electronic gadgets fitted in the spinning process, especially in blow room and winding, to minimize claims. New developments are taking place to enable further detection in carding, draw frames, etc. But none of these gadgets can ensure 100% removal of all types of contaminants. The problem of contamination has to be dealt with at the origin. For this, accurate information is needed on the nature and amount of contamination in different origins of cotton and their impact on yarn and fabric quality.

What is the acceptable contamination level for the end-user of yarn and cloth?

There are no established standards for the size and frequency of contamination acceptable in knitted and woven fabrics worldwide. Contamination, even if it is a tiny single fibre, leads to downgrading of yarn, fabric and garments to second quality, or even total rejection of an entire batch or shipment.

Most end-users demand zero contamination in the yarn and fabric without knowing the reality. A few, who understand, accept certain low levels, but even these levels are not within easy reach of spinners.

The size of contamination objectionable to the end users could be as small as 1 mm or less, while electronic clearers equipped on winding machines cannot clear items less than 1 cm.

Steps towards minimizing contamination

The contamination problem has to be attacked in cotton growing, picking and ginning. For this, a clear understanding of the actual nature and extent of contaminants present in different origins of cotton is necessary. It is also necessary to identify the dreadful type of contaminants which are difficult to remove even with electronic gadgets in the spinning process.

In addition, it is necessary to determine the threshold level of these contaminants in raw cotton – the level at which the spinner will be comfortable. Preventive measures must be identified in cotton growing, picking, ginning and baling processes to minimize these contaminants in raw cotton bales and ensure that the contaminants do not exceed the stipulated threshold level.

Manual contaminant cleaning at PT Apac, Indonesia

A large Indonesian spinning mill, PT Apac Inti Corpora, collected comprehensive data on the nature and extent of contamination in different origins of cotton, based on systematic contamination removal from over 260,000 tons of cottons in eight years.

This company consumes a large quantity of raw cotton (about 125–130 tons per day), imported from different countries, for the production of 100% cotton yarns and blends, greige fabrics and denim fabrics. They started manual cleaning of raw cotton to get rid of the contaminants and minimize complaints from their customers. About 100 tons of different cottons used for ring spinning are cleaned manually every day by a huge workforce and the contaminants thus collected are analysed.

Manual cleaning lines are designed by PT Apac in such a way as to easily detect even very tiny contaminants in raw cotton bales. The operators engaged in the manual cleaning are given a comfortable seat, good table and proper lighting. A part of the table has wire mesh to remove dust from the cotton, and a part has a smooth white surface to detect colour contamination. Up to 40 operators are engaged in each line, with a conveyer belt running in between two rows of tables (see figures 2.20–2.25).

Operators pick up very small tufts from the bales, open the tufts by hand and search for contamination. The contaminants detected are duly discarded in to the waste bags and the cleaned cotton is thrown to the conveyer. White polypropylene, oil, shiny spots, fungi, etc. are detected at the end of the conveyer under UV light. The cotton thus cleaned is re-baled, wrapped with cotton wrappers and stored with proper identification of shipment, type, etc.



Figure 2.20: General view of manual cleaning line



Figure 2.21: Cleaning table with wire mesh and white top



Figure 2.22: Contamination collected in waste bags



Figure 2.23: Cleaned cotton on the conveyer



Figure 2.24: UV checking



Figure 2.25: Repacked bales

The main advantage of this manual cleaning is effective removal of contaminants, to the extent of 98%–99%. Other advantages are: very thorough blending, good opening, less fibre damage, effective removal of sand and dust, reduction in stickiness, reduction in load on electronic clearers in winding and improved winding efficiency, accurate information on the nature and extent of contamination in cotton shipments and, finally, authentic feedback to the cotton suppliers.

What proportions of bales from different origins are contaminated?

Extraneous contaminants are found in cotton from all origins, without any exception. Not one single cotton shipment was found to be totally free from contamination in the last eight years. However, raw cotton bales from different countries differ in the degree of contamination. Broadly, cottons from 15 origins can be classified into 3 groups – group I with low contamination, group II with medium levels of contamination, and group III with high level of contamination – as can be seen in table 2.2.

	Origin	% of bales contaminated	% of fibrous contaminants	Amount of contamination
Group I (low contamination)	Australia Brazil China Mexico United States	10%–20%	60%–75%	1–3 g/ton
Group II (moderate contamination)	Mozambique Paraguay Uzbekistan West Africa Zambia	60%–80%	75%–85%	4–12 g/ton
Group III (high contamination)	India Pakistan Syrian Arab Republic United Republic of Tanzania Uganda Zimbabwe	90%–100%	80%–90%	20–100 g/ton

Source: M.N. Vijayshankar, Vice President, PT Apac Inti Corpora, Semarang, Indonesia.

All machine-picked origins are classed in the group of the least contaminated origins; China is supposedly the only hand-picked origin in that group.

Contamination with foreign matter is more serious with hand-picked cottons. Cotton gets contaminated during picking, storage, handling or transport of seed cotton. A major cause of contamination by plastic strings is the use of fertilizer bags made of woven plastic for picking and handling of seed cotton. As a result, hand-picked cottons in general, and those from India and Africa in particular, are discounted in the international market despite the fact that cotton spinners prefer the characteristics of the hand-picked cottons, which are cleaner, with fewer neps and a lower short fibre content, than mechanically harvested cottons.

It was also observed that there is a wide fluctuation in the level of contamination between shipments of the same type of cotton from the same origin, depending on ginning and growing conditions.

Typical contaminants observed are human hair, animal hair, cloth pieces, yarn pieces, polypropylene, polythene, plastic strings, bird feathers, metal parts, jute, ramie, bamboo, cable, rubber, newspaper, mint wrappers, wood, long bark, weeds and so on. The sizes of contaminants vary from fine hair or polypropylene weighing a few micrograms to ginning machine parts weighing as much as 15–20 kg. Photographs of some common contaminants and some special contaminants collected in manual cleaning are shown in figure 2.26.

Figure 2.26: Some typical common contaminants found in manual cleaning



Cloth pieces



Coloured & white polypropylene



Human hair



Animal hair



Plastic strings



Dyed and raw white yarns



Bird feathers



Paper



Polythene papers



Cable, wire, nuts, bolts, metal, PVC



Weeds



Long bark pieces



Mint wrappers



Jute threads



Special contaminants – Foot wear



Special contaminants – Bamboo and wood



Special contaminants – Cap



Special contaminants – Snake



Special contaminants – Torn notes



Special contaminants – Tins and cartons



Special contaminants – Baling M/C parts



Special contaminants – Ginning M/C parts

Fibrous and non-fibrous extraneous contamination in cotton bales

Broadly, extraneous contaminants in cotton bales can be classified into two groups: fibrous and non-fibrous contaminants.

Fibrous contaminants consist of:

- Human hair
- Animal hair
- Yarn pieces
- Cloth pieces
- Polypropylene fibres or strings
- Jute, ramie, hemp
- Plastic strings
- Long bark and weeds
- Bird feathers

All these contaminants disintegrate into tiny pieces in the process of opening and carding. They have almost the same buoyancy as the cotton, so it is difficult to separate them from cotton. As they are fibrous, they are easily twisted into the yarn body. Thus, fibrous contaminants are the worst component of extraneous contaminants. No chemical process can remove polypropylene and hair contaminants from yarn and fabrics. It is expensive to extract these contaminants from woven cloth, and they cannot be easily removed from knitted fabrics or garments as there is danger of causing holes.

Non-fibrous contaminants include:

- Paper, mint wrappers
- Cables
- Cartons
- Wood
- Stones
- Metallic wires
- Nuts and bolts, nails
- Parts from ginning machines
- Rubber
- Leather
- Tin
- Insects

These are somewhat easier to remove in the spinning process. However, they can cause damage to machine parts.

The quantity or weight of extraneous contaminants ranges from 2 to 100 grams per ton depending on the origin. Fibrous contaminants form about 65%–90% of total extraneous contaminants.

The quantity of contamination per ton of raw cotton seems very small in terms of weight. However, contamination is counted in cloth by frequency, not by the weight of the contaminants. One gram of fibrous contamination in a ton means 0.001% by weight, but this may equate to about 15,000 individual fibres (assuming an average length of 2 cm and denier of 10.0 for these fibrous contaminants)! The lighter the fibrous contamination, the greater the number, and hence the harder it is to remove them.

Electronic gadgets in the spinning process for removal of contamination

Spinners are forced to take action to minimize the problem by using electronic gadgets in the blow room and in winding. High investments are needed for installing these electronic gadgets, and highly skilled professionals are needed to handle and monitor them. When these gadgets fail or when their sensitivity changes, the results are disastrous. There are limitations to electronic detection as it depends on the speed of the process and the buoyancy, size and colour shade of contaminants. Full removal of contamination is not possible even if both blow room equipment and winding clearers are used.

Blow room

Anti-contamination gadgets fitted to the blow room line are helpful in early detection of large contaminants, thereby preventing them being pulverized in later processes. However, contaminants below a certain size (1 sq. cm) cannot be detected, and the majority of contaminants present in raw cotton bales are already below this size. Normally, about 60%–65% of contaminants can be removed with these gadgets in the blow room. Single fibre contaminants such as hair, fragmented feathers or tiny polypropylene fibres escape detection.

Winding

Finer contaminants are removed to the tune of 80%–85% in the winding process, at the cost of a significant drop in efficiency of winding and increased joints or weak points in the yarn. However, fibrous contaminants below 1 cm and with less 5% darker than the cotton cannot be removed. Most fine hairs and fine polypropylene fibres still pass through and are present in the yarn.

Effect of the initial level of fibrous contamination in bales on residual level in yarn

As mentioned earlier, fine hair, fine polypropylene and fibres from coloured yarn or cloth pieces are the most difficult of the fibrous contaminants to deal with. These contaminants are beyond the control of the spinning process, as they have the same buoyancy as cotton and can be twisted easily along with cotton fibres. Hence, it is very important to have low level of fibrous contaminants in the cotton.

Experience suggests that a level of less than 1 gram of fibrous contaminants per ton of raw cotton bales would help spinners to satisfy their customers and avoid complaints and claims, with due support from electronic gadgets in the blow room and winding processes.

Best solution: Solve the contamination problem at the origin

Obviously, the problem has to be tackled at the root: prevention is far superior to cure. Cotton growers, ginners and supporting organizations should take adequate measures to control fibrous contamination such as hair, polypropylene, cloth pieces, yarn pieces and bird feathers, thereby reducing the burden on spinners. This problem can be handled more by common sense than anything else. There is no high technology involved in preventing extraneous contamination in cotton growing, picking, storing, transportation and ginning. The following steps need to be taken by both growers and ginners.

- ❑ Wipe out the opinion that, because cotton is a natural fibre, the presence of contamination in cotton is normal. These contaminations are extraneous and not grown in the cotton plant.
- ❑ Educate everyone in the value chain – growers, pickers, and ginners – through visual media about the consequences of the problem.

- ❑ Wherever manual picking is in practice, insist on 100% white cotton uniforms, white cotton caps and white cotton picking bags for the pickers.
- ❑ Growers should be made aware of the danger in using polypropylene bags (from fertilizers and pesticides) for marking the fields as flags. It is better to use flags made of white cotton cloth.
- ❑ No hair cutting or trimming should be allowed near the fields.
- ❑ Animals and birds should not be allowed in the fields or the storage areas near ginning.
- ❑ When the leftovers from machine picking are collected manually by collectors, use 100% cotton cloth bags instead of polypropylene bags.
- ❑ Discourage cotton pickers and workers in ginning factories from bringing eatables and plastic bags.
- ❑ Workers in ginning factories also should use only white uniforms made out of 100% cotton and wear white caps to eliminate contamination from coloured cloth pieces and hair. Most of the big contaminants in ginned cotton are due to poor storage and poor material handling.
- ❑ Use 100% cotton bale wrappers. If cost is the reason for not using cotton wrappers for bales, then the best alternative would be to use thick polyethylene transparent wrappers, which cannot fibrillate.
- ❑ Ginners should regularly check the actual contaminants in the cotton using manual cleaning of a few random bales. It is better to know the problem at the ginning stage than to hear it from the users.
- ❑ Use electronic equipment to detect and reject contamination in ginning before pulverizing the contaminants.
- ❑ Introduce bonuses for clean picking and clean ginning.
- ❑ Consider contamination as one of the major quality parameters, just like effective length, micronaire and grade. Include risk clauses in the contract. More risk is involved in using cotton contaminated with hair and polypropylene than in using cotton of a slightly lower grade or length.

Conclusion

Cotton is under constant threat from artificial fibres, and presence of contamination is one of its main weaknesses. If this not controlled at the origin, it will have a serious impact on the whole cotton industry in the long run. Spinners might prefer to spin artificial fibre yarns and blends, rather than investing in expensive electronic equipment and still running a high risk in spinning cotton and its blends. It is high time for cotton growers, ginners and supporting organizations to get together and act on this issue, especially to minimize fibrous contaminants such as polypropylene, coloured threads, coloured cloth pieces and hair.

Classing and grading

Cotton classification

The term 'cotton classification' refers to the application of official standards and standardized procedures developed for measuring those physical attributes of raw cotton that affect the quality of the finished product and/or manufacturing efficiency. Classing methodology is based on both grade and

instrument standards used in tandem with state-of-the-art methods and equipment to provide the cotton industry with the best possible quality information for marketing and processing. Cotton classification includes the cotton quality determinations of colour grade, leaf grade, preparation, fibre length, length uniformity index, fibre strength, micronaire, colour Rd, colour +b, trash content and extraneous matter identification. As classing systems around the world progress, reliance on human senses is diminishing and instrument classing is expanding. Countries including Australia, Brazil, China, Uzbekistan and the United States have either fully implemented or are very close to fully implementing instrument classification on 100% of their cotton crops.

Manual grading of cotton

The traditional method of cotton classification is through manual grading. Manual grading is based on appearance and feel, and is accomplished mainly through the senses of sight and touch. Manual grading includes determinations for such factors as colour grade, leaf grade, staple length, preparation and the identification of foreign or extraneous matter. These determinations are made by trained cotton classers based upon visual comparisons with physical and descriptive standards. The use of standards has done much to promote uniformity of classing. However, the usefulness of a system of classification depends in a large part on the uniformity of application. Since manual classification of cotton depends on human perceptions of sight and touch, and involves the exercise of human judgement, the grade determinations of manual classers are somewhat subjective in nature. However, by careful study and proper use of grade standards, many of the common inconsistencies in the manual classing of cotton can be eliminated or reduced as their nature is recognized, their causes are learned and their remedies are developed.

Grade standards

Grade standards are necessary in any grading system for maintaining the integrity of manual classing. They represent the various grade levels for such factors as colour, leaf and preparation. The most recognized and widely used grade standards are the Universal Upland Grade Standards. These standards are maintained and distributed throughout the world by the United States Department of Agriculture (USDA). In addition to the Universal Grade Standards, many cotton producing countries have developed their own grade standards in order to more closely represent their own cotton.

The Universal Grade Standards are universal because of wide international acceptance. Twenty-three of the world's major cotton associations, representing 21 countries, are delegates to the Universal Cotton Standards Agreement. This agreement gives the signatory delegates a voice in how the Universal Standards are governed. Every three years, the delegates meet in Memphis, Tennessee, United States, to discuss and consider any changes to the standards.

The established colour grading system for American Upland cotton is made up of 25 colour grades plus 5 below-grade designations as shown in table 2.3. Fifteen of these grades are represented by the Universal Grade Standards. The remaining 10 grades are based on descriptive standards. For leaf grade, the seven 'White' colour grade standards also serve as the seven official leaf grade standards. These are also notated in the table below.

	White	Light spotted	Spotted	Tinged	Yellow stained
Good middling	11-1**	12	13	—	—
Strict middling	21-2**	22	23*	24	25
Middling	31-3**	32	33*	34*	35
Strict low middling	41-4**	42	43*	44*	—
Low middling	51-5**	52	53*	54*	—
Strict good ordinary	61-6**	62	63*	—	—
Good ordinary	71-7**	—	—	—	—
Below grade	81	82	83	84	85

* Physical standards for colour grade only.

** Physical standards for colour grade and leaf grade.

All others are descriptive.

American Pima Grade Standards are also represented in physical form. They comprise six official grades (numbered 1 through 6) for colour and leaf. All are represented by physical standards. There is a descriptive standard for cotton which is below grade for colour or leaf. The American Pima Standards differ from the Universal Upland Standards. Pima cotton typically has a deeper yellow colour than Upland cotton. The leaf content of the American Pima Standards is unique to this type of cotton and does not match that of the Universal Upland Standards. The preparation of the Pima Standards is also very different from that of the Upland Standards due to the use of roller ginning.

Both Universal Upland and American Pima Grade standards are valid only for a period of one year because of gradual changes in colour that occur as cotton ages. The grade standards for both American Upland and American Pima cotton are reviewed periodically to ensure they are still representative of their basis, which is the United States cotton crop.

Cotton colour and colour grades

When Upland cotton opens under normal conditions, it is white in colour. Continued exposure to weather and micro-organisms can cause the white cotton to lose its brightness and become duller. Upland cotton that has its growth stopped prematurely by frost, drought or other weather conditions may have a yellow colour that varies in depth. Cotton can also become discoloured by insects, fungi and soil stains. Discolouration may also be caused by oil or grease used in mechanical harvesting equipment, or by green leaves or other parts of the cotton plant that have been crushed by the machinery.

Regardless of the cause, any movement of Upland cotton colour from the bright white colour indicates deterioration in quality. Based on the Universal American Upland Grade Standards, all of these colour differences are recognized, divided into categories and described. The varying amount of yellow colour found in cotton is the basis for the colour groups used in the Universal Standards for grading Upland cotton. As shown in table 2.4 and figure 27, the Universal Upland colour groups are white, light spotted, spotted, tinged and yellow stained. Each colour group is represented by a colour name and a corresponding colour number (the second digit of the number represents the colour group).

As the cotton in each of the colour groups is exposed to weathering, it becomes progressively duller. The degree of brightness or dullness is the principal basis for grade divisions within each colour group. The higher grades are brighter in

colour than the lower grades. These divisions are also described through their name as well as a numerical designation. The grade divisions for brightness or dullness are represented by the first digit in the numerical name of the grade. The higher the number is, the duller or darker the colour will be. For example, a numerical colour grade of 11 represents very bright cotton in the white colour group whereas a colour grade of 61 represents very dull cotton in the white colour group.

In the Universal Upland Grade Standards, each of the 15 colour grade standards is made up of 6 cotton samples or 'biscuits'. The six biscuits in a grade standard display the range of colour that is acceptable within each colour grade.

When grading cotton for colour by visual inspection, lighting conditions are very important in order to maintain uniformity in classing. Lighting should not only be uniform and constant, but any artificial lighting used should provide colour rendering equal to that of daylight. Lighting in the classing room or laboratory should be diffused, but with enough direction to allow depth perception as the classer looks into the cotton. It should be as uniform as possible over all working areas in the room, and there should be no glare or cross-lighting.

Surrounding conditions are also important. All colours used in classing rooms or laboratories should be neutral, white, grey or black. Walls should be very light in colour. Light grey, just off-white, is preferable, so as to conserve the light. For more information on lighting in classing rooms for colour grading, see the American Society for Testing and Materials International (ASTM) Standard Practice for Lighting Cotton Classing Rooms for Color Grading, ASTM D 1684-96 (Re-approved 2002).

Cotton trash and leaf grades

Cotton usually becomes contaminated by leaf and other trash because of exposure in the field and harvesting methods. The amount of trash or foreign matter remaining in the lint cotton after ginning is largely dependent on the trash content, the condition of the cotton at the time of harvest, and the amount of cleaning and drying machinery used in the ginning process. Even when cotton is carefully harvested under ideal field conditions, it is very difficult not to include at least some pieces of leaf and trash.

Leaf includes dried and broken plant foliage of various kinds. It can be divided into two general groups: large leaf; and 'pin' or 'pepper' leaf. Leaf grade is an important factor and represents a loss, since it must be removed in the manufacturing process. From the manufacturing standpoint, leaf content is all waste, and there is a cost factor associated with its removal. Large leaf is generally less objectionable because it is easier to remove in the manufacturer's cleaning process.

The classer's leaf grade is a visual estimate of the amount of cotton plant leaf particles in the cotton. In the Universal American Upland Grade Standards there are seven leaf grades, designated as leaf grade 1 through 7. All are represented by the physical standards as previously discussed. In addition, there is a 'below grade' designation, which is descriptive.

Preparation

Preparation is a term used to describe the degree of smoothness or roughness of the ginned lint cotton. As a general rule, smooth cotton has less spinning waste and produces a smoother, more uniform yarn than rough cotton. Various methods of harvesting, handling, and ginning cotton can produce readily

apparent differences in preparation. Abnormal preparation in Upland cotton has greatly diminished in recent years because of improvements in harvesting and ginning practices.

Extraneous matter

Extraneous matter, also referred to as foreign matter, is any substance in the cotton other than fibre or leaf. Extraneous matter may consist of materials such as bark, grass, spindle twist, sand, dust, oil, whole seeds, seed coat fragments, motes or stems. Any sample containing an appreciable amount of such material should be designated with the proper classification remark annotating its type and contaminant level.

Use of instrumentation in cotton classification

Cotton testing instruments have been under development and in small-scale use since the 1960s. However, it was not until the early 1990s that the cotton industry began to accept instrument classification on a wide-scale basis. In 1991, USDA implemented instrument classification on 100% of the United States crop. Current instrument classification in USDA includes measurements for upper-half-mean length, length uniformity index, strength, micronaire, colour Rd/+b, and per cent area trash. Classing operations throughout the world have also adopted instrument classification. When using cotton testing instruments for classification, there are several critical elements necessary to maintain precise and accurate results. They include calibration standards, lab conditions, sample conditioning and instrument verification procedures.

Instrument standards

In order to maintain the integrity of a classification system, official standards and standardized procedures should be used throughout system. Instrument standards refer to cottons used for instrument calibration and/or test level verification. The internationally accepted standards for instrument classification are the Universal HVI Cotton Standards which are produced and distributed by USDA. These standards include calibration cottons for the measurements of micronaire, upper-half-mean length, length uniformity index, and strength. USDA also provides colour calibration tiles for colour calibration and Universal HVI Colour Standards for the verification of actual cotton colour testing levels. Like the Universal Upland grade standards, USDA's instrument standards are universal standards and are recognized under the Universal Cotton Standards Agreement.

Cotton selected for use in instrument calibration must pass rigorous screening procedures. As a first step, USDA conducts an extensive search across the United States crop by reviewing instrument classification data. Uniform lots of cotton bales with fibre properties within the desired ranges are targeted. Candidate bales are purchased from growers or merchants and then shipped to USDA. Candidate bales undergo rigorous instrument testing to verify bale uniformity and to establish standard values. Bales meeting USDA's high standards for acceptance are established for use as calibration cotton.

Establishing values for calibration cotton

In addition to a high degree of within-bale fibre uniformity, bales selected as calibration standards must meet the length and strength criteria for their intended use. For example, a typical Upland long/strong calibration cotton bale will have a length and strength of approximately 1.17" (29.7 mm) and 33 g/tex. An Upland short/weak calibration cotton bale will have a length and strength of approximately 1.00" (25.4 mm) and 23 g/tex.

Currently, six laboratories work together to establish values for Universal HVI Calibration Cottons. These consist of four USDA laboratories, one independent laboratory within the United States and one independent international laboratory. The independent United States and international labs are required to operate under the same rigid specifications as USDA in order to participate in the value establishment process. Combining all laboratory tests, a minimum of 120 tests are required on each bale in order to establish values. Laboratory results are compiled and analysed to confirm each bale's uniformity and to determine the standard values for establishing the bale as calibration cotton. For reference purposes, samples previously established as benchmark calibration cottons are included in the testing along with the samples from the candidate bales. The benchmark cottons provide the required reference level for accurate value establishment. If the test results within a bale are not within prescribed limits, the bale is rejected. If all testing criteria are met on a bale, the bale is accepted and packaged into 5 lb (2.27 kg) units for distribution as a Universal HVI Calibration Cotton.

Calibration of instruments

Instruments are calibrated for upper-half-mean length, length uniformity index, micronaire and strength by using Universal HVI Calibration Cottons. USDA established tiles are used to calibrate colour and trash measurements. Calibration should be performed at regular intervals for each factor. USDA recommends the following calibration tolerances for instrument testing:

Instrument determination calibration tolerance

Micronaire (units)	±0.100
Colour Rd (units)	±0.400
Colour +b (units)	±0.400
Trash (% area)	±0.050
Length (inches)	±0.007
Uniformity (%)	±0.700
Strength (g/tex)	±0.500

Laboratory conditioning

Atmospheric conditions influence the measurement of cotton fibre properties. Therefore, the temperature and relative humidity of classing laboratories must be tightly controlled. Temperature should be maintained at 21 degrees Celsius (70 degrees Fahrenheit), plus or minus 1 degree Celsius (plus or minus 2 degrees Fahrenheit), and relative humidity should be maintained at 65%, plus or minus 2%. For ASTM International Lab Conditioning Standards for Cotton Classification, see the Standard Practice for Conditioning and Testing Textiles, ASTM D1776-04.

Sample conditioning

Prior to instrument testing, cotton samples should be conditioned to bring the moisture content to equilibrium with the approved atmospheric conditions. Properly conditioned samples will have moisture content of 6.75%–8.25% (dry weight basis). There are two methods for conditioning samples: passive conditioning and active conditioning.

In passive conditioning, cotton samples are placed in single layers in trays with perforated bottoms to allow free circulation of air. The samples must be exposed to standard atmosphere conditions for 48 hours in order to assure thorough conditioning.

In active conditioning, a rapid conditioning device is used in which air at standard atmospheric conditions is drawn through the sample until the required moisture content for instrument testing is attained. Depending on the type of rapid conditioning device used, the time required to condition samples properly can be reduced to as little as 10 minutes.

The moisture content of conditioned samples should be monitored by checking sample moisture prior to instrument testing to verify that the appropriate moisture content has been reached.

Instrument verification procedures

Minimum performance requirements for classing instruments should be an integral part of any cotton classification system. Newly purchased instruments should be evaluated with a series of thorough tests before they are accepted and put into operation. Instruments should also be re-evaluated annually, typically before each cotton grading season begins. Testing should be done to verify both precision and accuracy of instrument measurements. The term ‘precision’ refers to the ability of an instrument to produce the same measurement result time after time. The term ‘accuracy’ refers to how well an instrument measures a certain property in relation to its true value.

Fibre length

Upper-half-mean length is the average length of the longer half of the fibres. It is measured in both hundredths of an inch and millimetres. For trade purposes, the instrument length is often converted into staple length. Table 2.4 gives the conversions from inches to staple length. Instrument-based length is performed by passing a small tuft of parallel fibres, commonly referred to as a ‘beard’, through a sensing point. The beard is formed when fibres from a sample of cotton are grasped by a clamp, then combed and brushed to straighten and parallel the fibres.

Inches	32nds	Inches	32nds
0.79 & shorter	24	1.11–1.13	36
0.80–0.85	26	1.14–1.17	37
0.86–0.89	28	1.18–1.20	38
0.90–0.92	29	1.21–1.23	39
0.93–0.95	30	1.24–1.26	40
0.96–0.98	31	1.27–1.29	41
0.99–1.01	32	1.30–1.32	42
1.02–1.04	33	1.33–1.35	43
1.05–1.07	34	1.36 & longer	44 & longer
1.08–1.10	35		

Fibre length is largely determined by variety, but the cotton plant’s exposure to extreme temperatures, water stress, or nutrient deficiencies may shorten the length. Excessive cleaning and/or drying at the gin may also result in shorter fibre length. Fibre length affects yarn strength, yarn evenness, and the efficiency of the spinning process. The fineness of the yarn that can be successfully produced from given fibres is also influenced by the length of the fibre.

Length uniformity index

Length uniformity index (LUI) is the ratio between the mean length and the upper half mean length of the fibres and is expressed as a percentage. If all of the fibres in the bale were of the same length, the mean length and the upper half mean length would be the same, and the LUI would be 100%. However, there is a natural variation in the length of cotton fibres, so LUI will always be less than 100%. Table 2.5 provides a general guide for interpreting LUI.

Degree of uniformity	LUI (%)
Very high	Above 85
High	83–85
Intermediate	80–82
Low	77–79
Very low	Below 77

LUI affects yarn evenness, yarn strength and the efficiency of the spinning process. It is also strongly related to short fibre content (fibres shorter than 1/2" or 12.5 mm). Cotton with a low LUI is likely to have a high percentage of short fibres. Short fibres are largely removed as waste while those remaining tend to aggregate during drafting (grasping and pulling with increasing speed) and cause thick places in yarn. Yarns with thick places are not uniform and cannot be used in high quality products. Short fibres reduce the strength of ring-spun yarns and the thick places are frequently points of weakness in yarns. The aggregates of short fibres can cause processing disruptions known as ends-down.

During the ginning process, fibre breakage can reduce LUI by adding to the short fibre content. When fibres are removed from the seed during ginning, some fibres break at a point other than near the seedcoat and must be removed in two pieces. Fibre breakage is also caused by lint cleaners. Immature fibres have less resistance to breakage than mature fibres. Cotton with low micronaire has comparatively lower LUI than high micronaire cotton. Fibre strength also affects resistance to breakage. Stronger cotton generally has higher LUI than weaker cottons.

Fibre strength

Strength measurements are made on the same specimen or beard of cotton as used for measuring fibre length. The beard is clamped in two sets of jaws, spaced 1/8" apart, and the amount of force required to break the fibres is measured. Strength is measured in terms of grams per tex (g/tex). A tex unit is equal to the weight in grams of 1,000 metres of fibre. Therefore, the strength reported is the force in grams required to break a bundle of fibres 1 tex unit in size. Table 2.6 can be used as a guide in interpreting fibre strength measurements.

Degree of strength	HVI strength (g/tex)
Very strong	31 & above
Strong	29–30
Average	26–28
Intermediate	24–25
Weak	23 & below

There is a high correlation between fibre strength and yarn strength. Also, cotton with high fibre strength is more likely to withstand breakage during the manufacturing process. Fibre strength is largely determined by variety. It may be affected by plant nutrient deficiencies and weather; however, it is less influenced by adverse growing conditions than are length and micronaire.

Micronaire

Micronaire is a measure of fibre fineness and maturity. An airflow instrument is used to measure the air permeability of a constant mass of cotton fibres compressed to a fixed volume. The volume of airflow through the specimen of cotton fibres is expressed as the micronaire.

Cottons with micronaire measurements between 3.7 and 4.2 are considered in the premium range of micronaire. Cottons within the micronaire ranges of 3.5–3.6 or 4.3–4.9 are considered base quality, while cottons above 4.9 or below 3.5 are in the discount ranges.

Micronaire measurements can be influenced during the growing period by environmental conditions such as moisture, temperature, sunlight, plant nutrients, and extremes in plant or boll population. Favourable growing conditions result in fully mature fibres with premium range micronaire readings. Unfavourable conditions, such as lack of moisture, early freeze, or any other conditions that interrupt plant processes, will result in immature fibres and low micronaire measurements. High micronaire cotton is caused by such things as abnormally warm temperatures during boll maturation, or poor boll set leading to excessive availability of carbohydrates and over-maturing of fibres.

Fibre fineness affects processing performance and the quality of the end-product in several ways. In the opening, cleaning, and carding processes, low micronaire or fine-fibre cottons require slower processing speeds to prevent damage to the fibres. Yarns made from finer fibre result in more fibres per cross section, which in turn produces stronger yarns. High micronaire or coarse fibres are not suitable for fine yarns since the result would be fewer fibres per cross section, which would reduce the yarn strength. Dye absorbency and retention varies with the maturity of the fibres. Low maturity fibres have poor dye absorbency and retention while higher micronaire fibres have good absorbency and retention.

Instrument colour

Instrument colour in cotton classification is measured in units of reflectance (Rd) and yellowness (+b). Rd indicates how bright or dull a cotton sample is and +b indicates the degree of yellow colour pigmentation. Low Rd levels indicate dullness or greyness while high Rd levels indicate brightness or lack of grey. High +b levels indicate a high degree of yellowness while low +b levels indicate a low level of yellowness. Figures 2.27 and 2.28 relate Rd and +b levels to Upland and Pima colour grades. The vertical axis in these figures indicates Rd and the horizontal axis indicates +b.

The colour grade as established by the Universal Upland Cotton Grade Standards is determined by the degree of reflectance (Rd) and yellowness (+ b) as shown in the Upland colour chart in figure 2.27. The colour grade as established by the USDA American Pima Standards is determined by Rd and +b as shown in the Pima colour chart in figure 2.28. Colour grades can be interpreted from Rd and +b measurements by locating the point at which the Rd and +b values intersect on the colour charts. Since 1999, USDA has utilized the instrument instead of the human classer for determining colour grade for official Upland cotton classification.

Figure 2.27: HVI colour chart for American Upland cotton

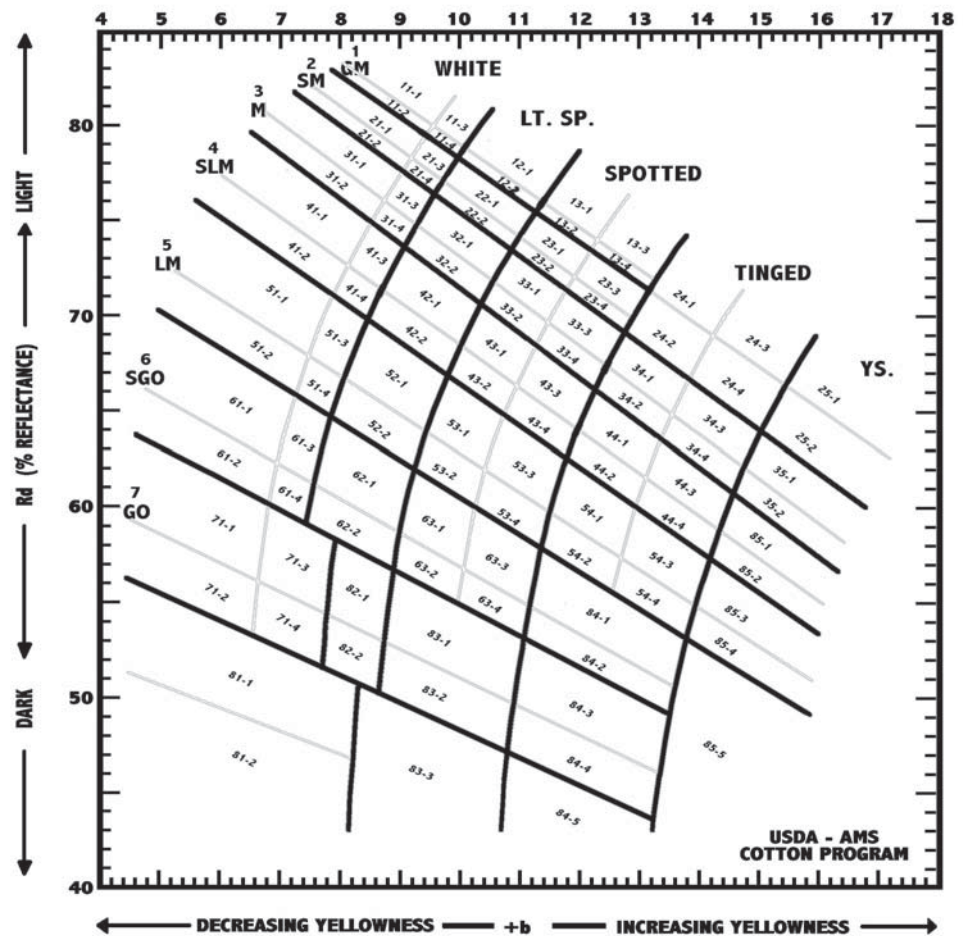
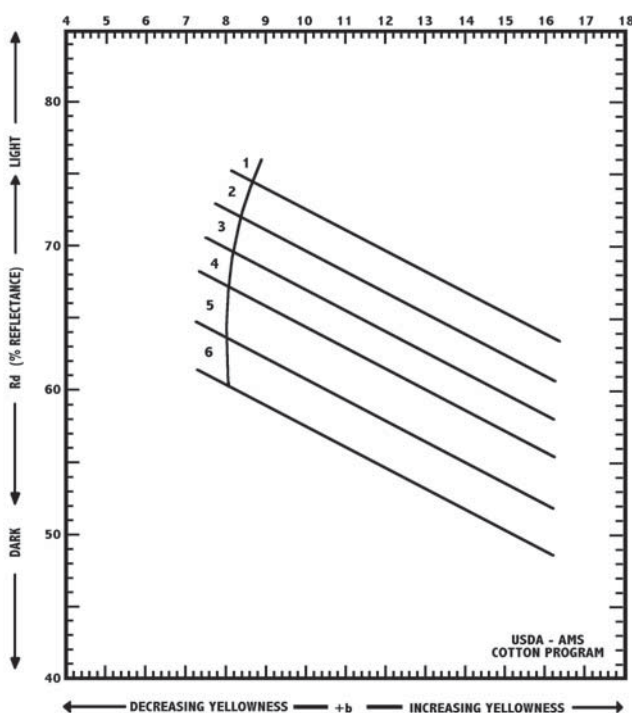

Figure 2.28: HVI colour chart for American Pima cotton



The colour of cotton fibres can be affected by rainfall, freezes, insects and fungi, and by staining through contact with soil, grass, or the cotton plant’s leaf. Colour can also be affected by excessive moisture and temperature levels while cotton is being stored, both before and after ginning. As the colour of cotton deteriorates because of environmental conditions, the probability of reduced processing efficiency is increased. Colour deterioration also affects the ability of fibres to absorb and hold dyes and finishes.

Trash

Trash is a measure of the amount of non-lint materials in cotton, such as leaf and bark from the cotton plant. The surface of the cotton sample is scanned by a digital camera and digitized for image analysis. The percentage of the surface area occupied by trash particles and the number of trash particles visible are calculated and reported. A high percentage area of trash results in greater textile mill processing waste and lower yarn quality. The ratio between percentage area of trash and

trash particle count is a good indicator of the average particle size in a cotton sample. For instance, a low percentage trash area combined with a high trash particle count indicates a smaller average particle size than a high percentage trash area combined with a low trash particle count. Small trash particles or 'pepper trash' are very undesirable because they are more difficult for the textile mill to remove from the cotton lint than larger trash particles.

Harmonization of rapid machine testing of fibre quality

It is a vastly different challenge to utilize an HVI for process control within a textile mill than to use a network of HVIs to classify, buy and sell cotton on the world market. HVI machines within companies do not have to be harmonized with other machines outside those companies. Thus, these HVIs do not have to be *accurate* (i.e. provide the 'true value' of the fibre property measured). As long as they are acceptably *precise* (i.e. produce measurements that are 'repeatable'), then the operators of the mill can learn how to advantageously apply the measurements toward the effective utilization of cottons.

If, however, cotton is to be bought, shipped and paid for based on stipulated values of the fibre properties, then the HVI machines have to be both accurate and precise. The 'official' classification instruments must be the arbiters of the 'true values' for the fibre properties measured. In an open global market, such authority cannot be mandated; it is a matter of trust, which must be earned and justified repeatedly. Therefore, the HVI machines used for official test results must be continuously harmonized with one another over disparate locations and times. Achieving this is both complicated and costly.

Up to now, only the following parameters are rated as sufficiently reliable by the ICAC Task Force on Commercial Standardization of Instrument Testing of Cotton (CSITC):

- Micronaire;
- Strength, based on HVICCS calibration;
- Length (UHML, based on HVICCS calibration);
- Length Uniformity Index (UI)
- Colour Reflectance (Rd);
- Colour Yellowness (+b).

Understanding HVI and how to make it serve a global market

HVI was made possible by applying computerization to the control and delivery of instrument measurements. Before computerization, high-volume measurements were fundamentally impossible. The addition of facilitating robotics made sample delivery, preparation and handling of samples go even faster and resulted in fewer errors.

The central question to be considered in this section is: How can HVI technology be applied over a large geographic area as the basis for buying and selling cotton? The answer, in summary, is that it requires the imposition of an adequate system of process and quality controls. This system encompasses more than the HVI machines and related protocols. It must extend back toward the cotton production and ginning sectors, through the classification system, and forward toward the cotton fibre market (see figure 2.29). Therefore, the system that is developed for different countries or regions of the world must be appropriate for the realities in the production and marketing sectors. It may be

Figure 2.29: Sectors encompassed in a harmonized HVI system

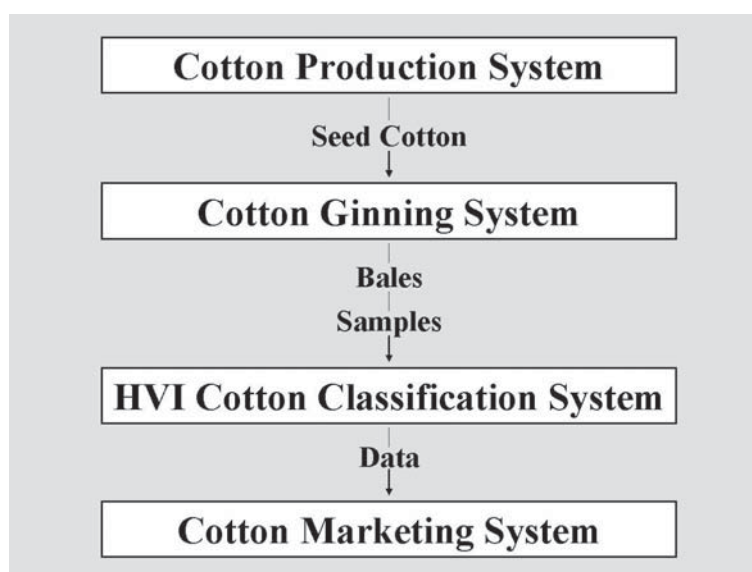

possible in some cases to alter these controlling realities at the margins, in order to accommodate the system of process and quality controls, but the feasibility of this would have to be evaluated case-by-case.

The major components of this system of process and quality controls include:

- Well engineered and constructed HVIs
- Representative sampling
- Laboratory conditioning
- Sample conditioning
- Calibration
- Check-tests
- Standards cottons
- Transportation
- Certification and communication

Discussion of these components is aided by reference to the only large-scale HVI classing system currently in existence, in the United States. It bears re-emphasizing that the particular approaches used in different parts of the world can, indeed must, be altered to accommodate structural limitations and differences. However, while the specific approaches to the necessary components may vary, these components cannot be ignored.

Of course, well engineered and constructed HVIs are a ‘cornerstone’ of a reliable system. The HVI technology is well known, but the quality of the materials and components, along with exacting tolerances in machining and construction, are critically important. The key point is that machine error must be minimized, in order that other sources of errors in data generated may be adequately managed.

The sampling procedures are fundamentally important, for at least two reasons: sample variations are the single largest source of errors in HVI data; and the sample must be representative of the larger package of cotton that it is drawn from. Procedures to ensure this would have to be very different for large-scale, mechanized farms than for small-scale, subsistence farms. The key point is that the sample must be ‘representative’ or the HVI data will be useless.

Laboratory and sample conditioning procedures deserve special emphasis for two reasons. First, these are required to achieve either accuracy or precision in HVI testing. And second, around the world there is a remarkable tendency to fail in meeting this requirement. Apparent causes for this failure are an inability to bear the necessary expense and a lack of appreciation of the sensitivity of test results to conditioning. The key point is that ambient conditions in diverse laboratories must be kept stable at targeted levels in order to achieve agreement between measurements produced from those laboratories.

Since cotton fibres will reach equilibrium moisture content under any given ambient conditions, it is necessary for this equilibrium to occur before testing the fibres. In the United States, it has been determined that conditioned samples will have a moisture content between 6.75% and 8.25% (dry weight basis). As a matter of standard operating procedure, samples moving toward the HVI lines for testing are checked to verify that the moisture content falls within this interval.

The time required to achieve equilibrium depends, among other things, on the moisture content of the fibres going into conditioning and the extent of exposure of individual fibres to the ambient conditions. There have been attempts to achieve equilibrium conditioning within air conditioning units incorporated with an HVI, but without success. It has been shown that forcing ambient air from a conditioned room through cotton fibre samples that are already in a near-equilibrium condition can achieve adequately conditioned samples in as little as 10 minutes. However, if the samples are simply exposed to the ambient air within a conditioned room, proper conditioning may take as long as 48 hours. Regardless of the technologies and procedures used, the key point is that equilibrium moisture content must be achieved if consistent measurements are to be obtained across space and time.

The calibration and check-test procedures require a designated, centralized quality control facility, where top-down guidance about calibration procedures is given to other cotton classing facilities throughout the country. In the United States, 1% of cotton samples tested at USDA satellite HVI facilities are randomly selected each day and air-shipped overnight to Memphis, in order to be tested on the quality control HVI machines there. Daily check-testing has been found necessary to identify calibration problems and correct them before they become untenable. The key points are that calibration procedures must be adequate and consistent among the satellite HVI facilities, and that frequent verification of satellite HVI machines is necessary for adequate quality control.

Standards cottons are absolutely necessary for meaningful calibration procedures. A designated authority should be the official source of standards cottons. Furthermore, this is one function for which there should be only one authority for the entire world; otherwise, cooperation and collaboration among the different HVI classification systems around the world would be greatly impeded. In the United States and in most other HVI testing facilities around the world, the standards cottons are provided by the USDA/AMS facility in Memphis, Tennessee.

The standards cottons must exhibit very low sample variations; i.e. the fundamental, real-world problem of large natural variations in cotton samples must be systematically alleviated. Lack of homogeneity must be alleviated by careful blending and mixing of the fibres. The more homogeneous the fibres, the less painstaking the blending and mixing will have to be. The key point is that the end result must be standards cottons that are exceptionally homogenous.

Transportation procedures must be reliable and fast enough for moving the samples of the ginned fibres from the gins or other departure point to the classing facilities, and from the classing facilities to the calibration/check-test centre. In the United States, where producers maintain ownership of the cotton

after it is ginned, the samples are collected at the gin points. The cotton samples are packaged and labelled as the cotton bales come out of the gin bale press. Trucks under contract to AMS systematically run designated routes to gins and deliver the collected samples to the classing facilities.

The transportation process for producers' samples is a primary determinant of the locations of classing facilities throughout the United States. The locations must allow for both the production densities and the driving distances in the production regions across the country.

As previously mentioned, randomly selected samples are shipped by air to the centralized check-test centre. Time is of the essence for maintaining adequate quality control, so air shipment is a necessary expense.

For movement from gins to classing facilities, the key point is that the bale record represented by samples must be accurate and delivered in a timeframe that does not interfere with the orderly marketing of the cotton. For movement to a calibration/check-test centre, the key point is that samples must be delivered and tested rapidly, in order to maintain the integrity of quality control.

Certification and communication procedures are indispensable supports for acceptable verification, identity preservation and efficiency of market transactions. Computerization and telecommunication technologies have revolutionized these components of the system in the United States. At the classing facilities, a barcoded tag sent with each sample is scanned into the computer database and the data collected on the sample is automatically accumulated in the electronic files, without manual entry of information. (Exceptions are human classers' determination of leaf grade and extraneous matter, which are entered once by hand.) The result is a combination of high speed, low error rates and excellent identity preservation that could only be wished for a decade ago. The system is highly reliable, yet does not produce a traditional 'paper trail'; a paper copy of the information generally occurs only when the owner of the cotton prints it out at his or her own computer terminal. All these developments have removed substantial costs from the marketing system.

Of course such record keeping and communication of data can be done in a multitude of ways. The key point is that certification of bale identities and accompanying fibre property data must be reliable and must be communicated in a timely manner.

Implications for national HVI systems

Taken together, the foregoing components of a system of process and quality controls provide indispensable guidance to plan for large-scale harmonization of machine testing of fibre properties. The magnitude of the logistical/management issues – especially the timeliness required for reaction and adjustment – immediately recommends that sovereign countries should provide the basis for a national HVI cotton classification system. Advantages of national authorities include the fact that they facilitate funding of capable central authorities (it is futile to attempt HVI classification without large and sustained funding). Besides funding, national governments can provide an enforceable rule-of-law, which is necessary for the classification system to reach a threshold level of trust within the global market.

The structure of national HVI systems must vary according to national industry structures. For example, in most of the world cotton producers lose ownership of cotton before it is ginned. They sell the seed cotton before ginning and before HVI testing. Therefore, since the cotton is not sold based on HVI test results, it is not necessary that sampling and reporting of test results be focused at the gin

points, as it is in the United States. Unfortunately, this approach fails to give the cotton production sector an incentive to deliver improved fibre properties – unless some method for identity preservation is available to allow differential pricing back to the producers. But it does allow for both sampling and testing to be done later at one or more collection points in the marketing system. Perhaps these collection points could be at port facilities in cotton exporting countries, which could enable efficient HVI testing on cotton going into export markets. (Domestic users who were interested in HVI results could also source cotton from these collection points.) Such an approach would facilitate logistical efficiencies and economies of scale that would make feasible the delivery of harmonized HVI data.

Conclusion

There are nine components that make up an adequate system of process and quality controls for an HVI cotton classification system:

- ❑ Machine error must be minimized by well engineered and constructed HVIs.
- ❑ Cotton samples must be representative of an entire cotton bale.
- ❑ Ambient conditions in diverse laboratories must be kept stable at targeted levels.
- ❑ Equilibrium moisture content must be achieved in the cotton samples before testing.
- ❑ Calibration procedures must be adequate and consistent among the satellite HVI facilities.
- ❑ Calibration of satellite HVIs must be frequently verified by check-tests at central quality control HVIs.
- ❑ Standards cottons must be exceptionally homogeneous.

The bale record represented by samples must be accurate and delivered to HVI facilities within a timeframe that facilitates orderly marketing. Check-test samples going to the centralized quality control facility must be delivered and tested rapidly.

Certification of bale identities and accompanying fibre property data must be reliable and must be communicated in a timely manner.

Given these components, the imperatives of funding, and the realities of training and management, it seems very likely that globalization of HVI classification of cotton must be advanced one country at a time. The feasible role of an international authority is probably limited to advice, facilitation, and perhaps in some cases a quality control oversight role. All experience to date says that meaningful quality control is a relentless, time-sensitive task, which would make global centralization either too slow or too expensive. If cotton is being tested on a daily basis, then check-testing must be done on a daily basis and the lag between satellite testing and check-testing must be minimized. Otherwise, errors cannot be corrected in a timely manner and the integrity of the data on fibre properties is lost.

Cotton bale packaging

Cotton is packaged, stored and transported in units called bales. A cotton bale consists of cotton fibres removed from cottonseed during the ginning process and packaged for convenient handling, storing and transporting. Bales are formed at the end of the ginning, drying and cleaning process by accumulating cotton fibres in a chamber called a press box. While being held in the press box,

bulk cotton fibre is compressed by hydraulic rams typically creating forces up to 4 million N (newtons). Straps or bands are added at the press box to contain cotton fibres to form the bale.⁵

Historically, bale sizes and densities have been specified based on a compromise between requirements for efficient storage, optimum space and weight for transport, and energy required for compression. Additionally, ease of opening and mixing bales for textile processing is an essential requirement, especially as mills become more automated. Early in the history of cotton production and ginning, most cotton producing areas of the world devised their bales and pressing capacity for the benefit of their domestic mill customers. Since the earliest mills typically were located near the same region as the gins, there was no efficiency to be gained by producing high density bales. In the past century, cotton has been traded more internationally, which has demanded additional efficiencies for dimensions, densities and mill opening requirements.

Packaging and labelling requirements also have changed over the past century. A shift has been made from heavy steel bands and buckles and heavy jute fabrics toward more technically advanced bands, fabrics and films. Practically all wrapping and strapping materials have realized significant improvements in performance while decreasing shipping weights.

Dimensions and density

The inside dimensions of the bale press determine the cross-sectional dimension (length and width) of the bale. Press design is decided by the baling press manufacturers so once the press is installed, the ginner can control only one dimension: the height. The height is determined by the degree of compaction and the length of the bands or ties. There are numerous weights, sizes, dimensions and densities of cotton bales produced around the world. Bale weights may be as great as 330 kg as in some Egyptian bales and as low as 100 kg as in old-type bales observed in China. However, recent advances in standardization are rapidly reducing the variation among cotton bales. Today most bales are compliant with the International Standard ISO-1986 (E).⁶ The nominal dimensions and density of the ISO-compliant bales are shown in the following table.

Length (mm)	Width (mm)	Height (mm)	Density (kg/m ³)
1060	530	780–950	360–450
1400	530	700–900	

Figure 2.30, as copied from the ISO standard, depicts the external dimensions of the cotton bale. L is the overall length of the banded bale, W is the overall width of the banded bale and H is the overall height of the bale. The recommended density is 450 kg/m³. Bales meeting ISO standards are of optimum size for use in ISO containers having the nominal length of 12 metres.

5 The newton (N) is the unit of force defined in the International System of Units. One pound force = 4.448 N and 1 kg force = 9.806 N. Forces of cotton bale compression vary greatly depending on the size of bale and density pressed. For example, the force required to press a 330 kg bale, typical of many Egyptian bales, will be much higher than that required to press a 180 kg bale, typical of a bale of Ugandan cotton.

6 This International Standard lays down the nominal overall dimensions and the bale density of banded cotton bales. It applies to the shaping and forming, the transport and the opening of the bales. It does not apply to wrapping, to banding, or to the marking of bales.

Figure 2.30: Banded bale

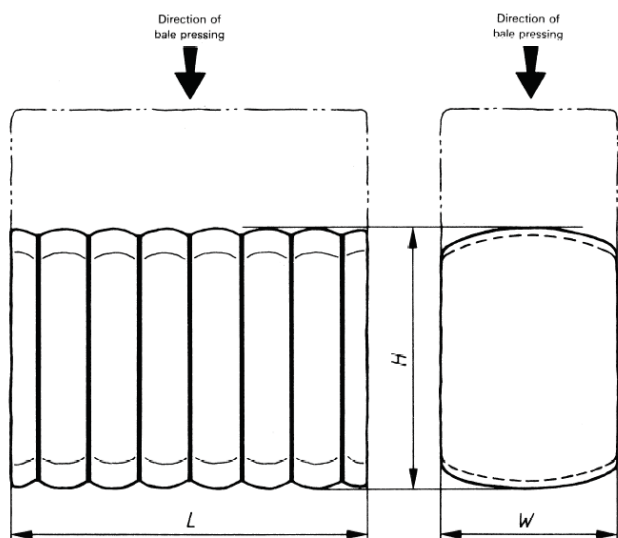

For most stable stacking, bales are normally stacked with their height horizontal, i.e. lying down; however, selection from warehouse inventories often makes it most efficient to stack bales on their heads, with the length dimension vertical.

Bale strapping or banding materials

Bale banding materials are typically constructed of steel bands, high tensile steel wire ties or plastic (polyethylene terephthalate) bands. It is especially critical that bale banding materials be strong enough to withstand the static loads containing the fibres in bales as well as impact forces of handling. Broken bands can represent a significant risk because of probable loss of fibre weight, inefficient handling, and contamination potential.

Cotton bales are formed under high compression; therefore high-strength bands must be used to restrain bales at the desired dimension. Typically, bands may have a strength capacity of up to 9,000 N per band. While the average static bale forces may be as low as 4,000–5,000 N per band, an additional safety margin is required to compensate for dynamic forces created during storage, handling and transport. Heavy bales can create much higher bale strapping forces than bales of average weight. Research has shown bale forces increase exponentially with increases in density; therefore, in a bale having a fixed length band, density increases in proportion to its weight increase. Similarly, a bale which may be formed with varying distribution of lint across its cross section is also subject to band breakage. Ginners usually discover quickly if lint distribution is a problem and make corrective adjustments before significant problems arise. Temperature and humidity changes also affect internal bale forces. Moisture conditions for the cotton fibre during compression are a significant factor: the lower the moisture content, the higher the force on the bale bands.

Optimum banding specifications, like bale size and density, represent a compromise of attributes. Steel bands having high load-carrying capacity are less likely to break than plastic bands under a given load. On the other hand, plastic bands allow elongation, relieving compressive static forces from the fibres, which in some cases actually decreases breakage. Steel is stronger than plastic at elevated temperatures, as may occur near a fire. Proper fire protection measures including sprinklers are recommended for all storage areas.

Steel bands are more difficult to remove in the opening room of the textile mill. Many mill opening room personnel prefer the ease of removal of plastic bands. While personal safety equipment to protect eyes, limbs and body from the forces of breaking bands is recommended for all bales, the risk of injury from removing plastic bands is considered to be less than that for steel. The arrangement of the strapping inside the protective wrapping material permits automatic opening of the bales by machine provided that the hoops are parallel.

United States specifications for bale packaging materials have been carefully researched and have been established to include sufficient safety factors to compensate for all except the most unusual circumstances. United States standards for bale banding materials are being widely adopted in many cotton growing areas of the world.

Bale cover materials

Protective wrapping materials are constructed of fabrics made from cotton, jute (burlap), polyethylene film and woven polypropylene. Bagging choices, like those of density and banding materials, involve weighing many factors including packaging costs, and levels of protection. The primary purpose of bagging is to shield cotton fibre from external contamination. Secondary benefits are reduction of lint loss and a decrease in fire risk from sparks or other ignition sources. If it were not for the need for these safeguards, cotton could be shipped bare, with no cover.

Increased automation has accelerated the adoption of bags that cover the entire bale. In addition to the labour-saving advantages of application at the gin or warehouse, advantages also accrue to the textile mill; full bags, being on the outside of the band, can be removed without the need for removing straps. Complete bag removal by mill personnel is labour-saving as well as reducing the risk of contamination. Bales may be thoroughly cleaned before band removal.

Each bagging material has advantages as well as disadvantages. Cotton bagging is desirable from the cotton consumption standpoint as well as reducing the concern of lint contamination from the packaging. The best cotton bagging is made of at least 270 g/m² (1.4 kg/bale) materials. Cotton bagging meeting those weight requirements performs its intended duty of protecting the bale under normal handling practices. Cotton bagging can be woven or knitted to form bags. Unfortunately, the cost of good cotton bagging is a limiting factor. Experimental non-woven cotton bagging materials have also been used. Non-woven materials formed by hydro entanglement, needle punch and nylon stitch bonding have been used, providing varying degrees of performance. Lighter weight bags of as low as 135 g/m² have been used with marginal success. As a general rule, higher fabric weights assure better protection. If price and performance were not factors, cotton bagging would be the cover of choice for all cotton bales.

Woven burlap is used considerably in the form of large bags that enclose the entire cotton bale as well as sheets or panels placed underneath the bands. Mill attitudes to burlap are mixed. Some mills claim that burlap fibres are contaminants. Other mills report that burlap is preferable to plastic materials, because burlap fibre is composed of cellulose similar to cotton. They claim that burlap fibres, if accidentally entrained in cotton yarn, can be bleached and dyed along with cotton. Others show evidence of yarn breaks caused by burlap fibres entering the cotton lint stream. Burlap allows for free atmospheric moisture equilibrium, unlike impermeable films which retard moisture vapour movement. Burlap disposal is handled in two ways. In some facilities, burlap fabrics are recycled and made into other bags. In other cases, burlap is disposed of along with other organic wastes. Burlap, like cotton, is a natural organic product that degrades naturally in the environment.

Polyethylene film, after cotton, is often chosen by textile mill owners for bagging. Its transparency allows cotton bale fibre to be visually inspected for moisture or other damage. Film also prevents dust, external moisture and similar contaminants from staining the fibre. Polyethylene film often is recyclable by the scrap plastics industry. Service businesses such as warehouses that have the responsibility for storing, handling and loading bales typically complain that polyethylene represents an increase in cost because its toughness and durability are not as good as woven polypropylene. Polyethylene film is recyclable by waste plastic businesses.

Woven polypropylene bagging is the toughest, and has the highest tensile and tear resistance of all bale bagging materials. Woven polypropylene is usually the product preferred by warehousemen and handlers of cotton bales as they perceive

it as protecting the fibre better than other materials. Textile millers do not universally agree on the attributes of woven polypropylene because of the fear of a strand of plastic yarn becoming entrained in raw cotton lint and causing yarn and fabric defects. Because of those concerns, woven polypropylene specifications for United States cotton bales mandate that all woven polypropylene fabrics be stabilized with a laminate coating to minimize yarn and fabric fraying. Woven polypropylene is recyclable, but recycling businesses may not exist in every textile mill area. Otherwise plastics must be disposed of in land fills, or incinerated. Pound for pound, when burned for energy plastic materials produce the same amount of energy as petroleum fuels.

While plastic materials in cotton fabrics represent a significant cost to world textile mills, by far the most contaminants originate at the cotton field or near the gin. Plastic strings, ropes and sacks that become entrained in seed cotton and passed into the ginning process generate millions of fibres that are not detected until cotton yarn and fabrics are made. There is only scant evidence that woven polypropylene bagging at the textile mill is a contaminant of consequence. In order to assess the risk of woven polypropylene yarns on the outside of the bagging at the textile mill, numerous investigations have been conducted to determine the risks and benefits of plastic bagging on spinning efficiency and fabric quality. Since 1975, United States textile mills represented on the United States cotton industry bale packaging committee (the body that conducts evaluations and recommends specifications to the USDA) have processed over 100 million bales of United States cotton wrapped in woven polypropylene with only minimal evidence of contamination confirmed to be from bagging. Woven polypropylene fabrics made to mandatory United States industry specifications require a chemical trace element to be used for investigating contamination. From dozens of investigations, virtually no evidence exists that bagging was a source of contamination. Laboratory and textile mill experiments also have demonstrated a low risk of contamination from woven polypropylene bagging made to United States industry specifications. Nevertheless, because of many other sources of plastic contamination experienced by textile mills worldwide, operators persist in their concern about woven plastic bagging being a contaminant.

Labelling

International Standard ISO 8115-3:1995(E) specifies that for identification purposes each bale of cotton shall have a mark that identifies the shipping lot. The mark should be identical to those on the bill of lading, the delivery order and other shipping documents.

The standard also stipulates that the marking colour or ink shall not penetrate through the protective wrapping, and that all bales shall be marked at the same position. The ISO standard further requires each bale to have a label giving the bale number in figures and barcode, along with gin number and/or name. United States cotton bales are permanently identified with unique bale identifiers that are consistent with the United States ginning and USDA records.

Textile processing

The textile process begins with bales of cotton and continues through various processes for the purpose of creating yarns and fabrics for many end-uses.

Yarn formation

Yarn formation is the process of converting loose cotton fibre into a yarn structure, involving a progression of distinctly different and separate processes. The primary functions of these processes are:

- Fibre opening and blending
- Fibre cleaning
- Fibre straightening and paralleling
- Formation of a continuous fibrous strand
- Twist insertion

Whatever the end result desired, proper fibre selection is the foundation of any successful spinning operation.

The requirements of the end-product, or of the consumer of the yarn, will be the dictating forces in determining the fibre quality and properties that are best suited for the most economic situation. Using fibre that is of better quality than required will prove unprofitable. Likewise, using fibre that is of poorer quality than required will result in losses. Therefore, correct decisions regarding the most suitable fibre properties for a given operation are paramount for maintaining profitability.

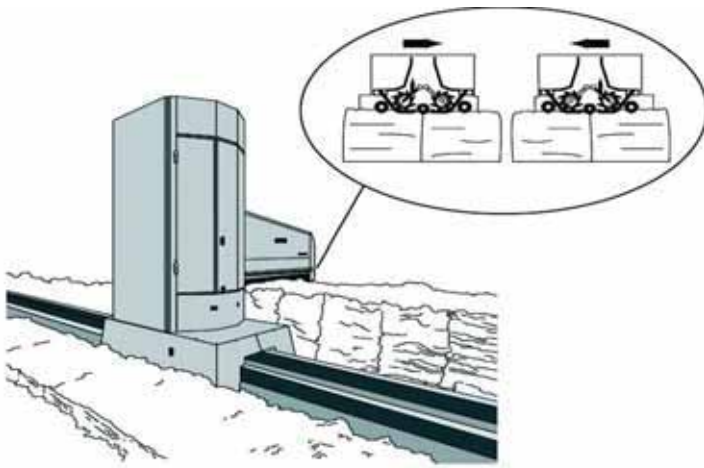

Figure 2.31: A bale plucker

A bale plucker feeds fibre to the spinning mill from an assemblage of individual cotton bales (a laydown). This step is considered part of the opening process. The plucker takes a small layer of fibre from the top of all the bales on each pass. Fibre is then transferred to the cleaning line. The inset shows how the plucker head removes a small layer of fibre from each bale as it travels back and forth along the laydown.

Opening

Opening breaks down compressed layers or clumps of fibre into small tufts, facilitating transport and efficient cleaning (see figure 2.31).

Blending

Blending brings together fibre tufts from many bales to form a consistent, homogenous mix.

Cleaning

Cleaning removes extraneous matter from desirable fibre.

There are four basic principles of cleaning:

- Beating action
- Density differences
- Centrifugal and inertial forces
- Air flow

Carding

Carding aligns, parallels, cleans and condenses fibre into sliver (see figure 2.32). Other important capabilities of carding are:

- Nep reduction
- Short fibre reduction
- Dust removal
- Levelling

Drawing

Drawing blends, straightens, and levels (see figure 2.33).

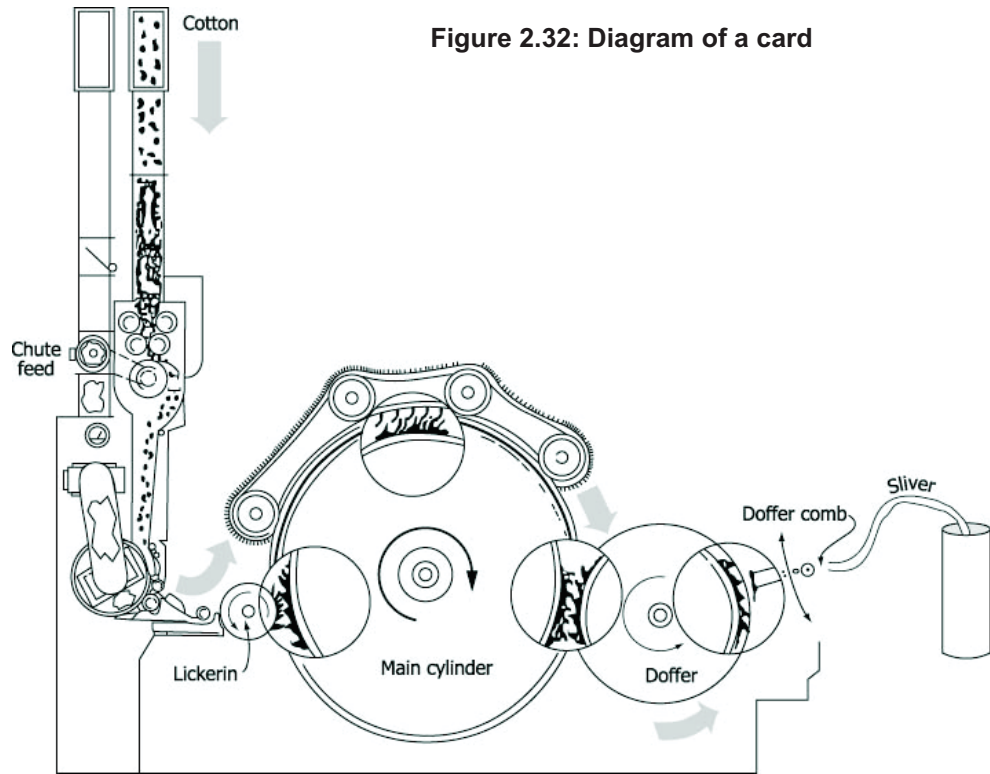
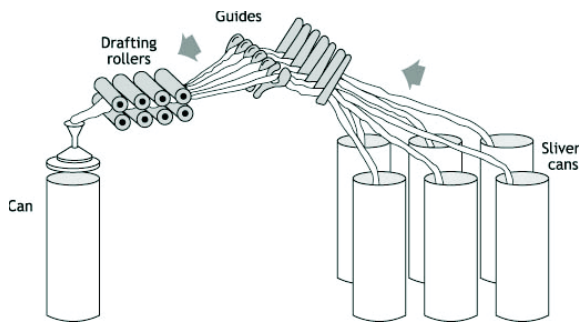

Figure 2.32: Diagram of a card

Figure 2.33: Diagram of drawing sliver



Lap preparation

Lap preparation combines a number of slivers into a wound, flat ribbon (lap), needed for combing.

Combing

Combing removes short fibres, straightens and blends.

Roving

Roving is an intermediate drafting process required for ring spinning that also places sliver on to a bobbin (see figure 2.34).

Figure 2.34: Diagram of a roving operation

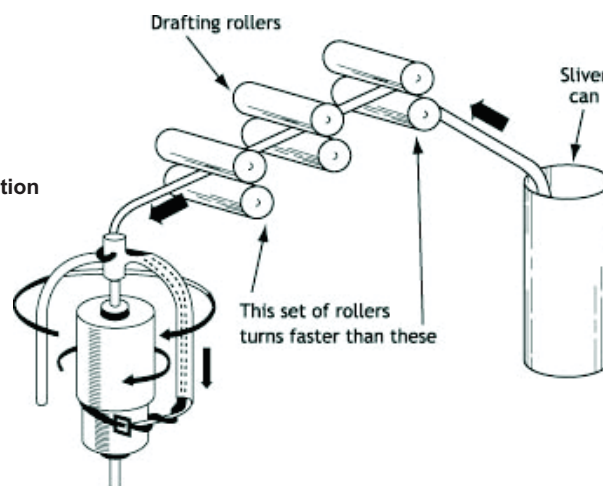

Spinning

The insertion of twist into the fibre strand is necessary to give integrity and strength to the fibre bundle. The methods employed for inserting this twisting action are distinctly different depending on the spinning technology used. Because the methods for inserting twist are different, the resulting yarn structures also display their own unique forms.

There are three main technologies available for inserting this twist for the purpose of creating a yarn structure. These are ring spinning, open end (or rotor) spinning, and air jet (vortex) spinning.

Ring spinning

Ring spinning inserts twist by means of a rotating spindle (see figure 2.35). Ring spinning is both the slowest spinning method and the most expensive because of the additional processes required (roving and winding).

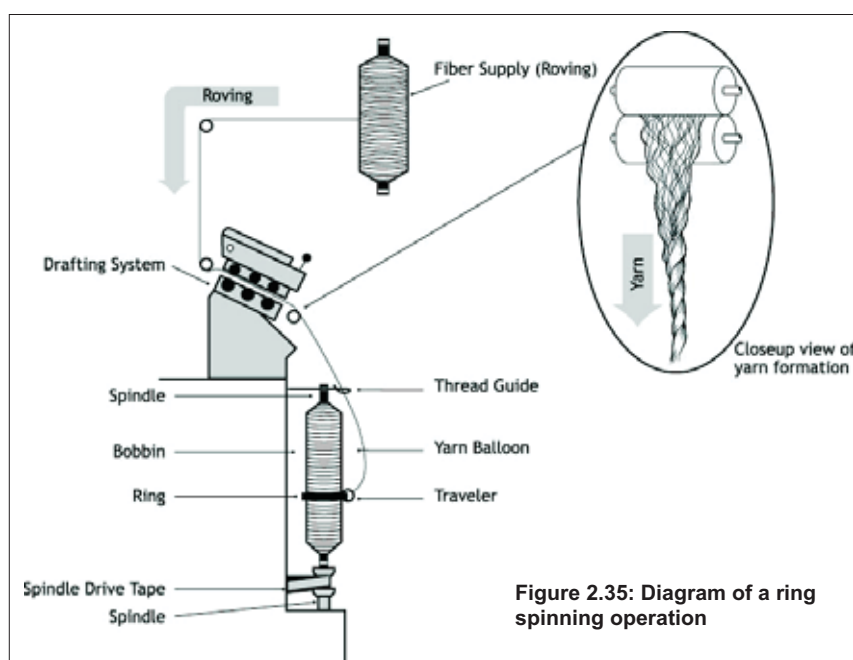

Figure 2.35: Diagram of a ring spinning operation

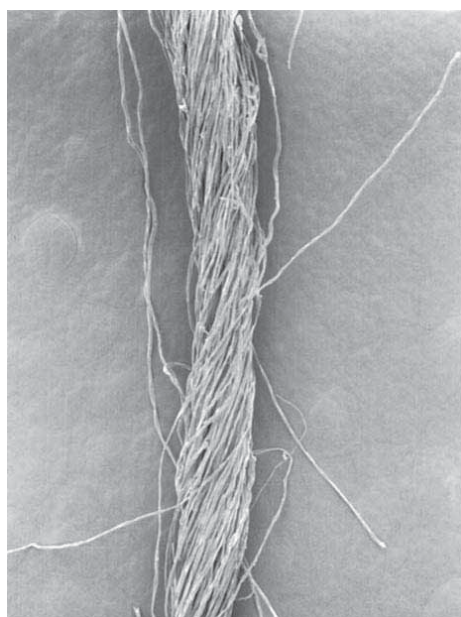

Figure 2.36: Ring spun yarn

This SEM image clearly shows the helix angle of twist that is responsible for holding the individual cotton fibres together. (M.J. Grimson)

Ring spinning produces the strongest, finest, and softest yarn (see figure 2.36). It is also the most mature spinning technology.

Open end (rotor) spinning

Open end or rotor spinning inserts twist by means of a rotating rotor (see figure 2.37).

Open end spinning has a high production capability. It has a low cost due to its high production rate and the elimination of processing steps. Open end spinning produces a weaker yarn than ring spinning, has a limited count range, and produces a yarn that is 'drier' or harsher in hand (see figure 2.38).

Figure 2.37: Diagram of an open end (rotor) spinning operation
(K. Charlton)

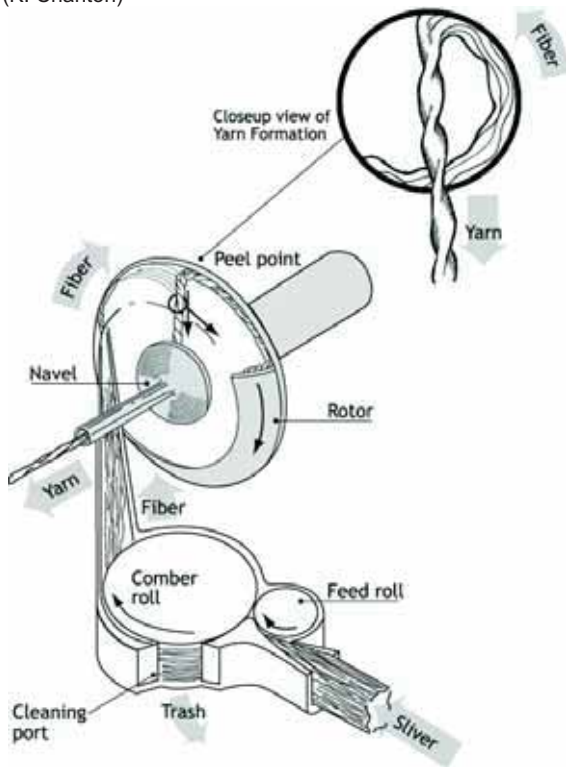

Figure 2.38: Open end (rotor) yarn

In comparison with the ring spun yarn (figure 37), the difference in yarn structure is very evident in this SEM image of an open end yarn. Note particularly the wrapper fibres that are perpendicular to the yarn form. (M.J. Grimson)

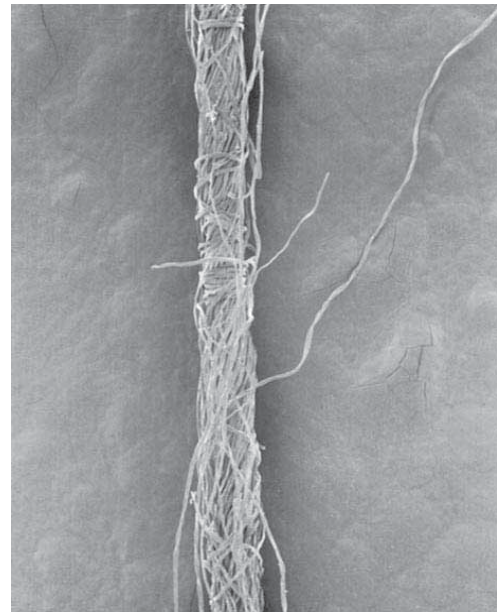
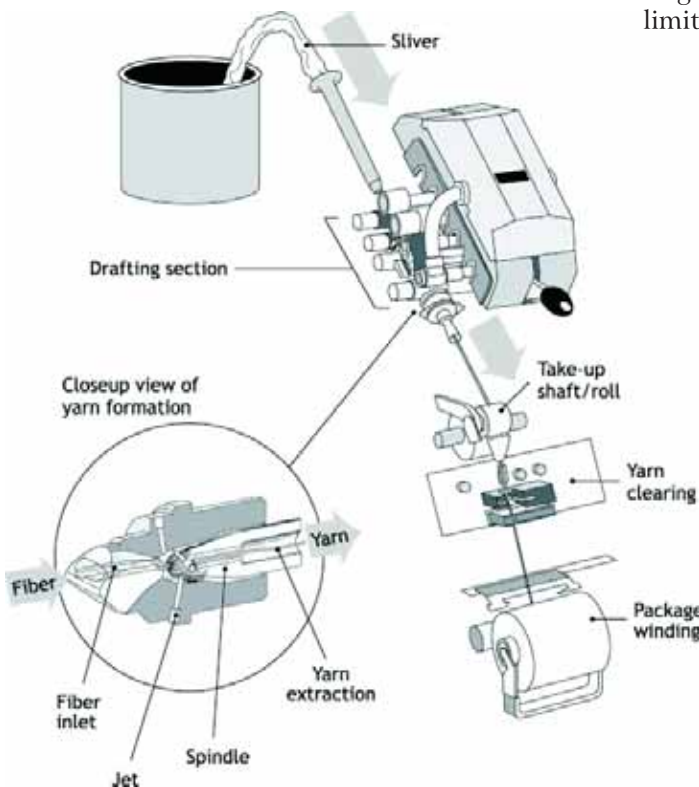

Figure 2.39: Air jet (vortex) spinning (K. Charlton)



Air jet (vortex) spinning

Air jet (vortex) spinning (see figure 2.39) inserts twist (see figure 2.40) by means of a rotating vortex of compressed air. Air jet spinning has a high production capability and a low cost due to its high production rate and the elimination of processing steps. Air jet spinning produces a weaker yarn than ring or rotor spinning (for 100% cotton) and has a limited range of yarn counts.

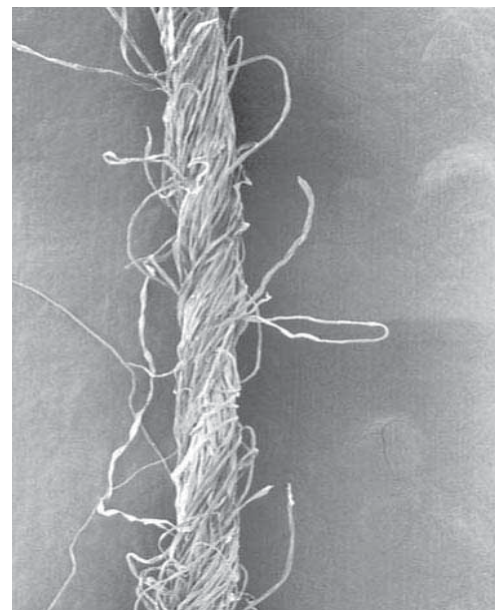

Figure 2.40: Air jet (vortex) spun yarn

This SEM image of a vortex yarn shows a high degree of similarity to the ring yarn structure. (M.J. Grimson)

As the yarn count gets finer, the yarn strength improves over open end spun yarns of the same count. Vortex yarn is appropriate for medium to fine yarn counts. The softness of fabrics made from vortex spun yarns usually falls between similar open end and ring fabrics.

Fabric formation

Spun yarns can then be used in the formation and production of fabric. There are two main methods for creating fabric structures from yarn – weaving and knitting. Each structure has its own unique characteristics and end uses. For instance, denim is a woven fabric and T-shirts are usually knit fabrics.

Woven fabric

Weaving involves the interlacing of yarns at right angles, much like making a basket. Depending on the set-up of the loom, many weave patterns and fabric constructions can be produced. (See figures 2.41–2.43.)

Figure 2.41: Diagram of a weaving loom

These elements of a loom show how a 'sheet' of warp yarns on the loom beam are fed into the harness heddles where they are alternately separated by an up-and-down motion in order to feed the weft, or filling, yarns perpendicular to the warp yarns. This continuous cyclical action creates the woven fabric structure.

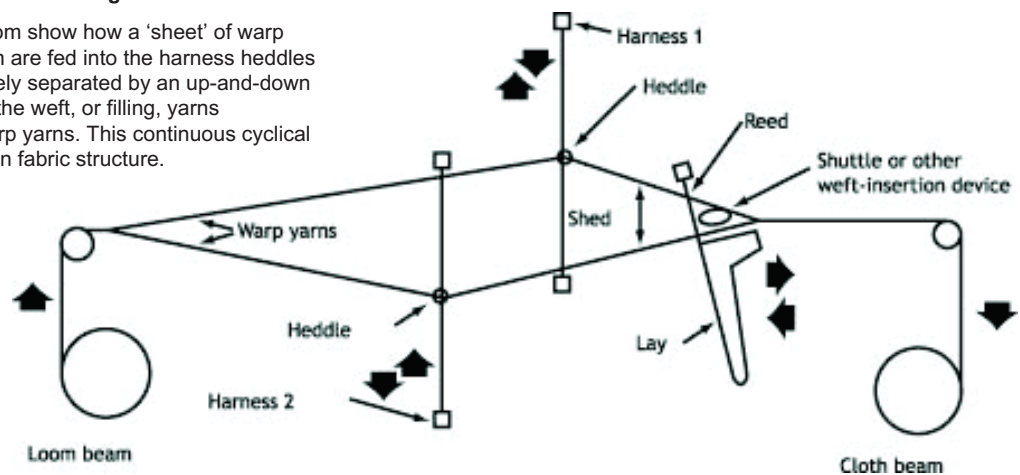

Figure 2.42: Woven fabric (plain weave pattern)

This SEM shows the interlacing/ basket-type configuration of the yarns in a woven fabric. (M.J. Grimson)

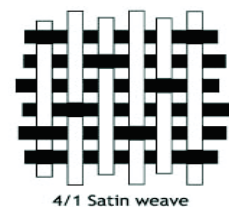
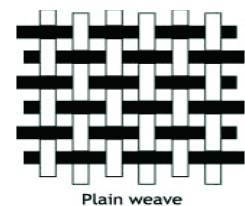
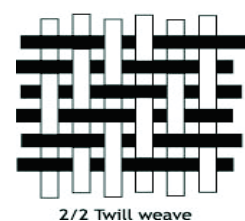

Figure 2.43: Basic weave patterns

These illustrations show examples of some basic fabric constructions.



Knitted fabric

Knitting involves looping the yarn or yarns around and through one another, much like hand knitting or crocheting (see figures 2.44–2.46).

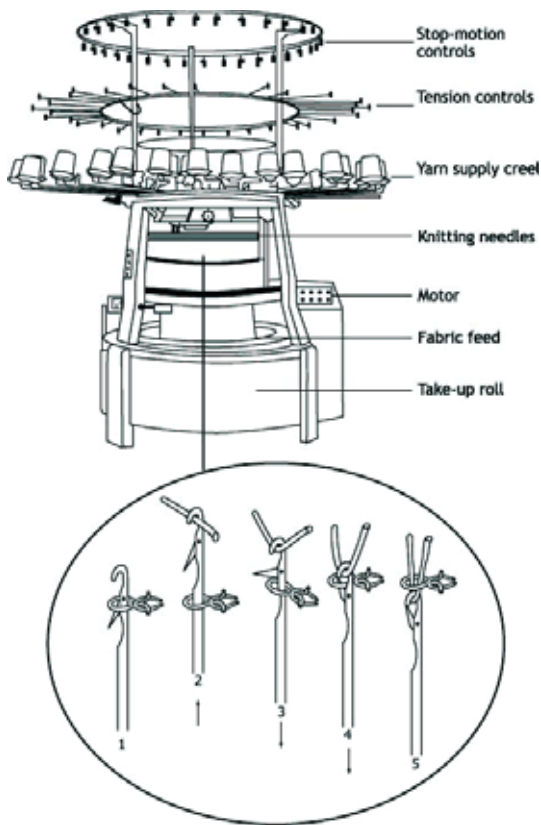

Figure 2.44: Circular weft knitting

(A) Circular (weft) knitting produces fabric in a continuous spiral form from numerous yarn supply packages.
 (B) Latch needle function and loop formation of knitting.

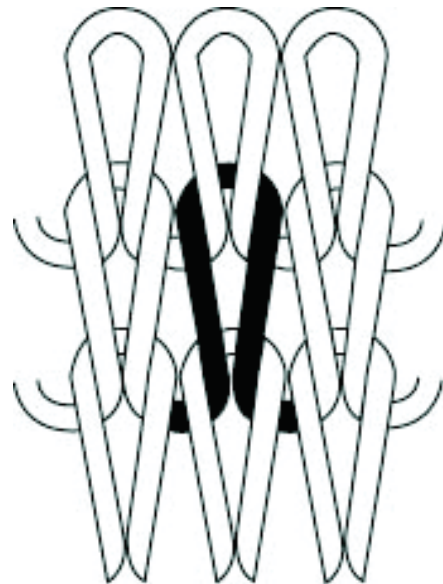

Figure 2.45: Diagram of knitted fabric



Figure 2.46: SEM of knitted fabric

This SEM of knitted fabric shows clearly the looping configuration of the yarns which is the basis of most knit structures.
 (M.J. Grimson)

Nonwovens

Nonwovens are fabric structures created directly from fibre, bypassing the need for yarn formation. These fabric structures depend on thermal bonding, chemical bonding or mechanical entanglement for their integrity. Varied processes, chemistry, and machines are required, depending on the specific end-product desired and the technology employed. Common uses of nonwoven fabrics include products such as diapers, disposable wipes and feminine hygiene products. United States paper currency is a nonwoven product using some cotton fibre (see figures 2.47–2.48).

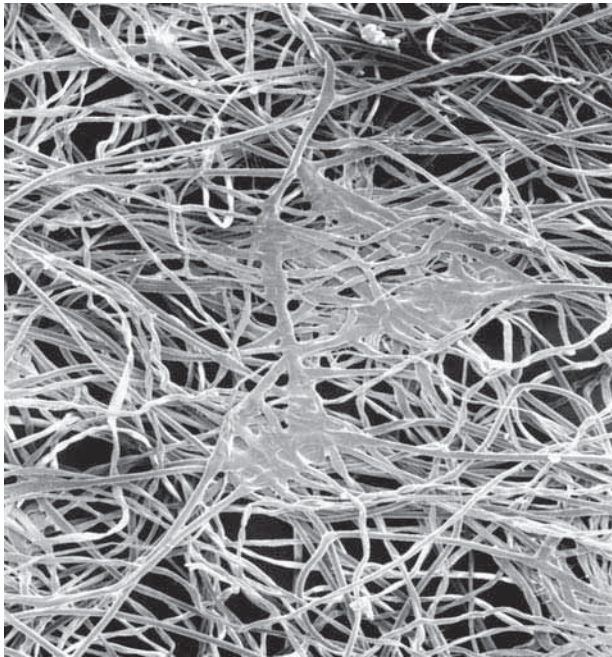

Figure 2.47: SEM of a thermal bonded nonwoven fabric
(M.J. Grimson)

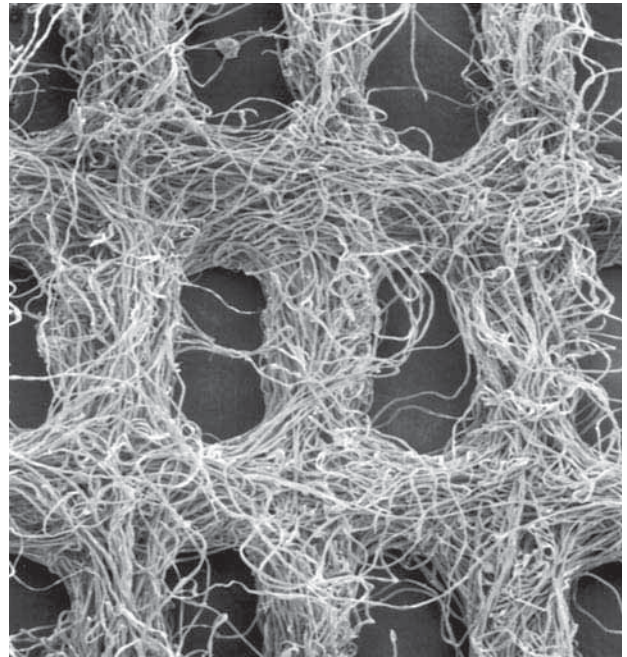

Figure 2.48: SEM of a hydroentangled nonwoven fabric
(M.J. Grimson)

Chapter 3

Cotton marketing

Contracts

The essential value of a well written contract

In the global cotton market it is important to establish a concise contract, placing particular emphasis on both parties holding a clear understanding of their joint obligations under the agreed terms and conditions. These terms and conditions should be clearly expressed and understood during the negotiations of 'offer and acceptance', and many of them are specific to the international trade in raw cotton.

Trade in cotton is generally conducted under a standardized set of terms and conditions. There are several recognized cotton trade associations assisting trade in cotton, of which the International Cotton Association Ltd (ICA), formerly the Liverpool Cotton Association Ltd, is most prominent. It is estimated that their rules are involved in approximately 60%–70% of global cotton contracts. This Association provides a draft international contract form for this purpose and a majority of cotton traded internationally is concluded under ICA Bylaws and Rules which can apply to contracts provided there is mutual consent. The ICA model contract can be found in the annex to this chapter on pages 167–168.

Parties can elect that any disputes will be resolved by ICA Arbitration; or they can mutually agree to limit ICA jurisdiction to either technical or quality matters arising from the contract.

Most sellers prefer to contract on their own personalized forms which contain, in general, a common or standard clear set of terms and conditions. Although under English law it is not mandatory to have a written contract it is commercially prudent. It is also important to recognize that for an arbitration agreement to be effective it must be made by 'an exchange in writing'.

When contracting it is necessary to be clear and concise in the identification of such items as the buyer's title and address and that of any involved agent or broker. The specifications and terms that apply to the contract, including items such as growth and quality, price, terms, shipment and payment, should be clearly and adequately expressed as they were agreed with the buyer. In addition contracts can include specific or special terms with the buyer's agreement.

It is important to recognize that if a contract incorporating the ICA Bylaws and Rules has not or will not be performed it cannot be cancelled by either party without mutual agreement and will be closed by being 'invoiced back' to the seller at a price to be agreed amicably between the parties. However, if this is not possible the invoicing back price will be determined by arbitration subject to English law.

Variations and amendments to the contract

After the terms and conditions of the contract have been agreed and prior to contract fulfilment it may be necessary, at the request of one party, to mutually agree to vary or alter the original terms and conditions. For example, the shipment period may be extended or the payment terms may be changed because of circumstances that develop 'post contract'. In such cases amendments should be documented clearly stating the changes, and that the statement is 'without prejudice' to the original terms of the contract. A contract amendment should be put in writing, issued and signed by both parties as evidence to the agreed changes.

In the event of disputes

Problems can develop and it is necessary to address such developments immediately so that each contract party has the appropriate time to try and protect its self interests. If the buyer is kept fully informed of any developments that may affect the terms and conditions and current or future performance of the contract it is likely the problem can be better controlled and any ensuing costs limited.

In relation to quality, if the contracted quality is unavailable it is prudent to inform the buyer and provide wherever possible a solution of reallocation or replacement. In the event of anticipated late shipment or late opening of the payment instrument it is prudent to advise the other party of any rescheduling at an early stage so that appropriate action can be taken to mitigate each party's position and costs.

Silence is no solution to a problem and in fact may result in delays, adding to costs and creating disputes leading to contractual default and arbitral action.

If a dispute cannot be settled amicably then the contract should contain the remedy and direction to an arbitral institution. Arbitration should be a last resort; priority should always be given to settling claims and disputes amicably and promptly.

Appointment of an agent

A majority of trade is conducted through a third party or 'agent', an intermediary acting on behalf of the supplier. The choice of agent can be fundamental to the positive and successful performance of the contract as agents hold an extensive knowledge of their market, local practices, and buyers' individual requirements in terms of quality and administration. The agent gives the seller a clear understanding of the workings of the market, market information and increased sales potential.

The agent will assist in negotiations at the offer and bid stage. The agent should monitor the contract performance and established timelines, and address any resulting problems or claims at an early stage before they develop into disputes.

The agreement between the seller (the principal) and its appointed agent should be documented in an 'agency agreement' and signed by both parties. This agreement should define the extent of the responsibilities of the agent along with any limitations. For example, the agent's client base may be defined or restricted, along with any other terms and conditions associated with the agency appointment.

Brokers work within a given geographical area, bringing local buyers and sellers together. Like agents they declare the name of both the buyer and the seller, and receive a commission but do not represent a party. **Traders** buy or sell in their

own name and for their own account. Agents or brokers who do not declare the buyer's name operate as traders because they take the cotton over in their own name.

Standard contractual terms

Quality – terms of valuation

Cotton fibre is produced at many different origins from a variety of seed varieties distributed under varying local controls and planted in different districts farmed and managed under different criteria and controls. The result is the production of a wide range of lint fibre properties influenced not only by these factors but also by climatic conditions throughout the planting, growing and picking cycles.

Cotton lint is marketed in different ways, and buyers rely on the supplier to meet the precise contractual quality specifications.

- *On description (based on 'Universal Standards')* is a system of manual classification of grade and colour with reference to the Universal Cotton Grade Standards. Universal Standard boxes are produced by USDA under the Universal Cotton Standards Agreement. Valuation of cotton lint is performed with reference to several different 'standard' boxes, created for that purpose by the accredited organization.

The role of standard boxes in the international cotton trade is to allow trading partners throughout the world to identify a quality of cotton by a written 'description', the quality being evidenced within the standard boxes, lodged and held by authorized bodies or 'signatories' which are the major international cotton associations. These standard boxes are available to anyone on application and payment of the appropriate fee.

- *Basis 'on type'* is the process of selling cotton fibre on the basis of a private 'type' (sample) which represents the specific named characteristics defined by the seller and is supplied to the potential buyer for approval. This may be an internationally recognized 'standard' type quality, and is sometimes traded by name alone if the quality is well recognized; however, it is envisaged that the potential buyer will hold a physical type at the time of contract. The 'type' may represent the grade (leaf/trash content and colour) and the staple length of the fibre, or just the grade alone; this will be defined on the seller's offer. Other characteristics obtained by mechanical testing may be expressed separately. Type samples should always be sealed to ensure that no manipulation of the contained fibre is possible.
- *HVI (high volume instrument testing) or SITC (Standard Instrument Testing)* is a fully implemented system that provides results not possible by manual or physical evaluation. The seller will specify in the contract the range of specifications they are content to offer. SITC fibre testing is operated by a majority of spinning mills in the world today, and an increasing percentage of cotton lint production is also being evaluated by SITC.

The testing authority should be agreed and stated in the contract.

- *Sale on government class* means a sale made based on government classification (e.g. USDA) based on grade, colour, staple length, micronaire and other standard measurements made by HVI. It is a practice in the United States to base sale on *green card*, or initial and obligatory classification of cotton performed by the USDA Classing Board when cotton is ginned. In Central Asia ginning mills issue *certificates of quality* with major quality characteristics of the fibre. In cases of deviation of quality from contract stipulations, value differences circulars issued by cotton associations can be used to settle

differences. The associations produce the value differences estimates for use during arbitration procedures to settle quality disputes between the contract parties.

- ❑ *Sale on certification* means that at the time of contract the parties will agree the basis of quality and insert a clause in the contract stating that an independent certification of quality will be conducted by a named independent international cotton controller. The certificate issued will form a part of the shipment documentation provided to the buyer. The certificate will identify the actual lot numbers and quantity, and be signed and dated by the appointed company.
- ❑ *Preshipment inspection and approval of actual stock lots* means that at the time of contract the parties agree the quality basis of the contract. A clause is added that permits the buyer to access the allocated lots of cotton and to inspect and sample prior to shipment. The buyer has the option of delegating a company representative or appointing an international cotton controlling company to attend the seller's nominated storage location to draw samples and value the fibre against the contracted quality basis. Shipment is not made until approval of the tendered lots has been received from the buyer.

Growth and quality

Growth and quality: the growth and origin of the cotton, or the agreed optional growths of the cotton, should be expressed in the contract. 'Quality' of cotton fibre can include the following identification of fibre valuations:

- ❑ Crop production year
- ❑ Seed variety of the cotton
- ❑ Obtained by either manual/physical classification or by mechanical testing:
 - Grade (leaf and colour)
 - Length (staple)
- ❑ Obtained by mechanical testing/SITC testing:
 - Colour grade
 - Leaf/trash content
 - Length (staple)
 - Micronaire (fineness)
 - Strength
 - Maturity
 - Uniformity
 - Moisture
 - Elongation
 - Short fibre index
 - Count strength product

If sales are made 'on type' or 'description' (based on the Universal standard boxes), unless otherwise stated, this would imply a physical valuation of the type sample. In the case of contracts mentioning, for example, strength (g/tex) or uniformity this would imply valuation by mechanical means. In this instance the contract may stipulate that certificates are to be supplied to evidence the mechanical testing/SITC results. It is prudent to stipulate which authority is to conduct tests and, in the case of certification, to certify the results. Alternatively, the tests may be conducted by the seller or under the seller's control or by an appointed third party without certification.

Whichever valuation method is used the buyer will, unless the contract stipulates certification is 'final', have recourse to claim on any lots which do not meet the contracted specifications and fall outside any permitted tolerance.

Quantity

Cotton is usually sold in lots, which vary in size from origin to origin. Contracts can be expressed in bales, by the number of 'standard' or 'high cube' containers FCL (20 or 40 foot), or by weight. All contracts are recognized contracts for weight and are based on the net weight of the shipment, so if for example '500 bales' are contracted and an average bale weight is stated as '200 kilos', the contract would be for 100 tons, allowing for any agreed weight tolerance. Weight tolerance gives the shipper much-needed flexibility within individual shipments. Normally the standard practice is to apply a tolerance of 3%–5% to cotton contracts.

Price and terms

Pricing can be 'fixed' or based 'on call', both expressed in a nominated currency depending on the parties' agreement and market tradition. Generally cotton prices are expressed in United States cents per pound or United States dollars per ton and sold in units of weight expressed in 'imperial' pounds, metric kilos or metric tons.

- *Fixed priced contracts*: are contracts where the price has been agreed at the time of contract and will not vary without the express agreement of the parties.
- *'On call' contracts*: are commonly known as a 'basis contracts'. The basis is agreed between the parties at the time of contract with reference to a nominated New York Cotton Futures trading month. The basis could for example be expressed as '200 United States cent points/pound off October New York'.

The mechanism for price fixing in an 'on call' contract is stipulated in the contract and expressed as either 'buyer's call' or 'seller's call'. In the case of 'buyer's call' the seller will fix the final price of the contract, or portion thereof, on the New York cotton futures month when he or she receives the buyer's instructions to fix. This must be prior to the first notice day of the future contract month and before the invoice is issued. If the buyer does not issue a fixation order and the parties have not agreed any extension to the fixation period the seller can fix the price.

Weight basis

There is an inherent natural moisture gain or loss in cotton bales depending on the atmospheric conditions in which the bales are stored and shipped. Most cotton is sold on the basis of 'certified landed weight' with each shipment requiring a weight adjustment or reconciliation upon arrival and discharge at the port of destination or mill premises, depending on the agreement or market tradition.

The standard formality for shipment is for the shipper to declare the 'gross' weight of the shipment. This is the weight of the cotton and the wrapping and wires that hold the bale in place. The 'tare' weight is declared on the invoice. This is the weight of the wrapping and the straps or wires. Most contracts use 'actual tare' in their reconciliation: the 'tare' is weighed and valued at the final destination and is then stated in the 'landing report' or weight reconciliation. The 'net' weight is found by deducting the 'tare' weight from the 'gross' weight and is the basis for invoicing the shipment.

The basis for weighing is often dictated by the available facilities at the origin. Most cotton is still weighed ‘bale by bale’. Certain locations, however, origin or destination, provide only ‘weighbridge’ facilities: the empty vehicle, trailer and/or container passes, prior to loading the cotton bales, over a ‘weighbridge’ scale and the weight is recorded. Once the cotton bales have been loaded on to the trailer or into the container the vehicle again passes over the weighbridge to ascertain the total gross weight of the cotton bales. This is calculated by deducting the weight of the empty vehicle, trailer and/or container (the ‘tare’) from the overall reported weight at the weighbridge. The bale tare weight is then deducted from the total gross weight, and the resulting figure is the net weight of the cotton fibre for that container/trailer load.

- *Gross landing weight*: can also be expressed as ‘certified landed weights’ and is usually conducted under supervision of an independent international weighing organization appointed by the seller. All cotton must be weighed under the supervision of the seller’s representative. Under ICA Rules there are specific time limits for weighing: for example, in the case of weighbridge weights 14 days (two weeks) from the date of arrival of the cotton, or 42 days (6 weeks) for bale weights.

The parties should establish the point of delivery for weighing and will cover the cost of their own representatives.

- *Gross shipping weights final*: are established under the control of the shipper’s and buyer’s nominated representatives and are usually final. It is normal practice for these to be established by an independent weighing organization or an organization agreed between the parties to perform the task at a named location. The time period for this task can be agreed separately by the parties. However, under ICA Rules it is to be conducted within 42 days (6 weeks) before shipment. It is important to ensure that weighing is conducted within the time allowed or that the time period is extended, or shipped weights are declared final with mutual consent of the parties.

Payment

There are various payment terms adopted by the raw cotton trade. Most trade is conducted under letter of credit (L/C) transactions. It is essential to be precise in the detail and mechanism for payment: for example, in the case of L/C transactions the payment clause should clearly specify the payment date or period, e.g. ‘at sight’ (on presentation of documents).

- *Letter of credit (L/C)*: may take several different forms, but unless otherwise stated they are all ‘irrevocable’ and cannot be cancelled. An L/C constitutes a definite undertaking by the issuing bank to pay provided the stipulated documents comply with the terms and conditions stated when presented to the ‘nominated bank’ or ‘issuing bank’. A ‘confirmed L/C’ is recommended to ensure payment, subject to the presentation of a compliant set of shipping documents. This requires confirmation to be added by the exporter’s (seller’s) bank or another nominated bank at the request of the ‘issuing bank’. It then provides a definite undertaking of the ‘confirming bank’ to pay, provided of course that all terms and conditions have been complied with.

L© payment terms can be ‘at sight’ or at a deferred date or period after presentation. This must be as agreed at the time of contract or contract amendment, as it obviously constitutes a cost consideration for interest.

The irrevocable confirmed L© is therefore an undertaking by the ‘opening bank’ (buyer’s bank) to reimburse the ‘beneficiary’ (the seller or other nominated party) upon presentation of a set of shipping documents fully in compliance with the specific list of documents in the L© and containing the

precise wording and clauses stipulated. Such documentation will normally include a set of invoices, original full set of bills of lading, weight/packing list, phytosanitary and/or fumigation certificate, and certificate of origin, along with other documents such as quality, inspection and shipping company certificates (the latter document may be called upon to stipulate the age of the carrying vessel).

A valid and workable L[©] should be opened by the buyer and advised to the seller in advance of the contracted shipment or delivery period. The contract should specify in the appropriate section the latest date the L[©] should be advised in order to allow the seller (shipper) the appropriate amount of time to prepare and effect shipment in accordance with the contract terms.

The list of documents specified under L[©] payment terms can be extensive. It is often based on the historical practice of the importing country or banking system within that country and bears little relationship to the documents actually required to effect import formalities. It is therefore important for sellers to check all requirements under an L[©] to ensure they can meet all the documentary demands within the timeframe permitted for presentation and negotiation. This is normally 21 days from the date of shipment (in the case of carriage by vessel, the date of the bill of lading).

Once the validity for shipment or negotiation has lapsed there is no security for payment, and the result may be an unpaid consignment lying indefinitely at a foreign port. If terms cannot be met the seller can only rely on an approach and the goodwill of the buyer to instruct their bankers to extend or amend the specific terms and conditions or to accept the discrepancies as advised.

The security provided by a letter of credit is only as good as its acceptability to the seller and the financial and commercial standing of the opening bank. Every care must be taken by sellers to ensure that they can comply with the L[©] terms with reference, and they should seek guidance from their bankers and also the advising or negotiating bank.

- *Cash against presentation of documents to a nominated bank*: provides an alternative payment mechanism but is not secure. It offers no payment guarantees and is normally used only between contractual parties with a long, regular and fairly secure relationship. Documents are dispatched by the exporter to his or her local bank, with instruction to be forwarded to the buyer's nominated bank for payment. Upon receipt of the documents at the buyer's bank, documents are presented to and accepted by the buyer who will authorize his or her bank to reimburse the value of the presentation, less a deduction of the bank's collecting charges. The documents remain in banking channels and there should be no concern of a loss of control of the documents, or the goods they represent, but there is no guarantee of or timing for payment.
- *Cash against presentation of documents on arrival of vessel*: is a similar payment term, with the exception that the due date for payment is the date the vessel arrives at the contracted port of destination or discharge. It is necessary under this payment method to ensure that a 'latest date for payment' is expressed in days commencing from date of bill of lading. Under ICA Rules this is stipulated as 49 days (7 weeks). This timing should be further stipulated in the contract and bank instruction letter to address the potential, for example, of an insured event and total cargo loss of the shipment or of the goods not arriving for any other reason.

Whatever method of payment is agreed, it is essential for exporters to have access to the financial status of their trading partner and to conduct any financial investigations necessary in advance of contract and shipment.

Prudence is essential in all transactions. It is the relationship between the parties that matters and that will eventually assist in addressing any documentary issues or difficulties arising from shipments. Mutual understanding of the trade and some flexibility is always required to resolve payment or documentary issues and releases. Delays in the release of the shipment due to non-payment can result in sizable costs being applied to the containers at the port of discharge, and should be avoided wherever possible.

Shipment

Shipment refers to the loading of the cotton on to a conveyance for delivery to the buyer or a carrier who will provide a bill of lading or combined transport document as a receipt. In the case of 'on board' bills of lading the captain or the captain's agent will sign the bill of lading when the goods are loaded on the vessel.

Most cotton today is shipped in 40 foot FCL (full container loads) under 'shipper's load, stow and count', meaning that the shipper takes responsibility for the contents of the containers, the majority of which are loaded or stuffed in the container yard. The container yard is where the containers are stored, collected or delivered, full or empty, and where loading and stuffing of containers is conducted by the shipper. It is the point where a shipping line or 'water carrier' accepts custody and control of containers for onward shipment.

Date of shipment: in the case of shipment by vessel this is the 'on board' date shown on the ocean bill of lading or the date the cotton is 'received' under a combined transport document.

Spot: goods are stored at a named fixed location or warehouse at the port or other named location for immediate delivery.

Prompt: in the case of tender or shipment, this is defined under ICA Rules as 14 days. It is prudent to avoid such expressions and ensure that specific dates or months are expressed in the contract to avoid ambiguity.

Shipment advice: the seller must provide the buyer with full details of the shipment as soon as these are available following shipment. This should include the name of the vessel, voyage number, bill of lading or combined transport document number and 'received' or 'on board' date, along with other information contained on the transport document (for example weight/number of bales and container/seal numbers). Under ICA Rules this must be done promptly. Otherwise the buyer has the option within 14 days of any deadline set out in the contract of closing the contract in accordance with the Rules. If the seller provides the invoice or shipment details after any deadline and the buyer intends to close out the contract he or she must inform the seller within three days. If there is no limit in the contract and the seller does not provide the invoice or details within 21 days of the date of the bill of lading, the above will apply.

Shipment delays: should be advised as soon as known to the buyer. Failure to inform can create problems, and potentially defaults. All delays should be documented wherever possible especially when the fault lies outside the control of the exporter. Claims of *force majeure* are evident at times but a notice for this or any delay in shipment can initially just extend the period allowed for shipment and not address the immediate difficulty facing the parties. Amicable solution is the best option and may include renegotiation of the shipment/delivery period, with any resulting agreement by the parties being duly documented.

The shipment month or period should be clearly stipulated, for example 'August 2008' or, for a spread shipment position, 'August/September/October

2008'. In the case it would be necessary to specify the quantities for each position should be specified. It may also be agreed to provide 'option months', for example 'August/first half September at seller's option' or 'September/October at buyer's option' or 'latest 15 August 2008'. Whichever expression is used, it is important to ensure that L/Cs are received and cotton lots are positioned for shipment to meet the shipment period.

Shipping companies often utilize a series of hub ports that serve as routing or transshipment stations where the containers are discharged from one vessel and reloaded onto the vessel serving the final port of destination. If the contract specifies a latest date of arrival or the duration of the voyage, it is important to ensure that the shipping schedule will fit with the buyer's requested arrival timing. Delays in shipment or arrival are a constant problem to buyers, who are increasingly dependent on 'just in time' arrivals to meet their production scheduling.

Freight – shipments by vessel

FOB (free on board) contracts: the buyers arrange the booking and payment of freight and must advise the seller or shipper before the commencement of the shipment month or period. The buyer should tell the seller the details of the freight booking in sufficient time for the positioning and loading of containers. The information should include the name and address of the shipping company and coordinates of the local representative office at the port of loading, name of the vessel, voyage number, and estimated time of arrival at, and sailing from, the contracted load port. FAS means 'free alongside ship'.

CF or CIF (cost including freight) contracts: the seller or shipper will arrange suitable freight and will book, pay the freight costs, and arrange all logistics at the port of loading or other nominated point of loading for the positioning of containers for loading and transport to the port for shipment. If the parties agree, the current cost of freight at the time of sale can be expressed in the contract. Any variation in this cost of freight from the date of contract to the date of shipment can then be directed for settlement to either the seller or the buyer. However, most CF or CIF contracts are based on 'freight final' terms, which means that the seller or shipper absorbs the risk and any variation in the rate of freight. Under this condition there is no recourse to the buyer.

Insurance

The responsibility to insure and the undertaking of risks are defined in the express terms of the contract. Under ICA Rules, whichever party is responsible for insurance must cover 110% of the invoice value of the shipment and must include:

- ❑ 'Marine cargo insurance' and 'transit insurance' in line with the Institute Cargo Clauses (A) or Institute Commodity Trades Clauses (A);
- ❑ 'War Risks Insurance' in line with the Institute War Clauses (Cargo) or the Institute War Clauses (Commodity Trades);
- ❑ 'Strikes, riots and civil commotions insurance' in line with the Institute Strikes, Clauses (Cargo) or Institute Strikes Clauses (Commodity Trades).

Unless otherwise agreed between the parties, sellers are responsible for 'country damage' (see below). Policy documents or insurance certificates should be produced as part of the shipment documentation providing cover for marine cargo insurance, transit insurance and country damage.

'Country damage' is generally recognized to be damage to or deterioration of the cotton fibre in the country of origin that has occurred prior to loading

containers or the vessel. It is caused by excessive moisture absorption or by dust or dirt (sand) contamination from the exterior of the bale, and is caused primarily by unsatisfactory storage or transit conditions. All care should therefore be taken when handling cotton bales and storage logistics at origin locations.

Special clauses

Special clauses are a 'free type' area in the contract that permits the parties to state any specific terms or conditions that apply to the contract. For example, this may include a statement containing an option that the sellers may apply to switch the origin of all or part of the contract, or may specify a latest date for an L/C to be advised.

Reverse side of the contract 'conditions'

Most sellers have established in their contracts a standard listing of terms and conditions that apply to every sale they conclude. The buyer must of course agree to these conditions. In a majority of cases a pre-existing relationship exists between buyer and seller so the standard contract form and layout is a recognized document. This section may reinforce certain terms or conditions and attach additional conditions, such as a section on 'carrying charges' (storage, insurance and interest costs that may apply in the event of a delay in shipment caused by the buyer's late opening of an L/C).

Main trade (logistical) terms and parties' obligations

Ex works: the seller places cotton at the disposal of the buyer at the agreed named location (ginning factory, warehouse etc.) It is the buyer's responsibility to arrange and pay for clearance of the goods for export and loading on to a mode of transport.

Free carrier (FCA): the seller attends to the clearance formalities for export, and delivers to the nominated carrier at the named location. The sellers are responsible for the loading only if this is conducted at their premises.

Free on board (FOB): applies only to shipment by sea or inland waterway. The seller clears the consignment, and delivery is effected when it passes the ship's rail at the contracted port of shipment. At this point responsibility for the cotton passes to the buyer.

Cost and freight (CFR): applies only to shipment by sea or inland waterway. The seller clears the cotton and pays for the freight. As with FOB, the cotton is delivered when the consignment passes the ship's rail at the nominated port of shipment. All risks for loss or damage or any costs arising from this point pass to the buyer.

Cost, insurance and freight (CIF): This applies only to shipment by sea or inland waterway. The seller clears the cotton and it is delivered when the consignment passes the ship's rail at the nominated port of shipment. All risks for loss or damage, or any costs arising from this point, pass to the buyer. However, the seller has to procure marine insurance to cover the buyer's risk of loss or damage during carriage.

Under ICA Rules the seller is responsible for any country damage on all the above terms.

Carriage paid to ____ (CPT): applies to all modes of transport. The seller clears the cotton and pays the delivery costs to the carrier and transport costs to the named destination and place of delivery. All risks and costs are the seller's.

Landed mill or delivered mill: the seller delivers cotton to a specified mill at its own cost. This term is usually used for sales to domestic mills in cotton producing countries.

The International Chamber of Commerce publishes *Incoterms 2000*, which contains an expansive listing of trade terms and specifies the responsibilities of the parties under contracts for the carriage of goods.

Documentation

Trade in cotton involves the passing of documents of title from the seller to the buyer. Most cotton trade involves a bill of lading, which will be accompanied by a selection of documents specified by the buyer and available to the shipper.

In the case of cotton lots sold from warehouse storage at the port of shipment or some other storage location within the country of origin, otherwise known as 'spot' sales, the title document would be a warehouse warrant or receipt. The receipt must be issued by the secure and bone fide warehouse company under the direct instruction of the seller, and the cotton should be free of all encumbrances, unless otherwise agreed between the parties.

Electronic documentation is playing a larger role in trade these days. The contractual responsibilities remain the same between the parties, and only the logistics are influenced.

All shipment documentation must comply with the terms and conditions of the contract, accounting for any amendments, and the terms of any payment instrument, for example L/C payment terms and conditions.

Shipment documents should provide an accurate picture of the shipment details and contain all required clauses and signatures. Wherever possible amendments should be kept to a minimum. If they are unavoidable, any documentary amendments should be duly endorsed by an authorized signatory.

Bill of lading: is a negotiable document of title, signed by the captain of the vessel or his or her named agent as receipt for the cotton goods received on board the vessel (the contract should specify the port of loading). The details usually contained in this document include:

- The full title and address of the shipper (seller);
- The title and address of the consignee (the buyer or receiver of the shipment);
- The 'notify party' – this can be the same as the consignee or may, for example, be a representative of the buyer at the port of discharge;
- Bill of lading number and date;
- Name of the vessel and voyage number;
- Port of loading;
- Destination/discharge port and any final delivery address;
- Cargo details – whether LCL/LCL or FCL/FCL, together with the container and seal numbers;
- A statement that the cotton is 'on board' (shipped on) the vessel, as opposed to 'received for shipment'.

Bills of lading are produced in sets. The number of original copies in the set is recorded on all originals and copies. Usually there are three in a set so, for

example, the expression used may be ‘3/3 original bills of lading’, meaning a full set. One reason for having several originals is to address the situation where the shipper sends the originals in two dispatches to minimize the risks of loss or delay during transit.

Any one of the original bills of lading may be lodged with the shipping line office or the local representative or agent operating for the line at the port of discharge to claim release and take delivery of the containers. Release is permitted only to the party named on the bill of lading.

Non-negotiable copies are also supplied in varying quantity as required. They hold no value in terms of title to the goods.

Endorsement/assignment of a bill of lading: may be assigned to a third party. Any assignment would have to be duly evidenced to the shipping company. It is important to check the assignment record to ensure the title is correct at the time of passing to any third party.

If the consignee is shown on the bill of lading only the consignee can take delivery and the original shipper has no further control over the shipment. The consignee may however decide to endorse the bill of lading to a third party.

If a consignee is not identified at the time of shipment the expression ‘consignee: to order’ may be used. The bill of lading is then endorsed on its reverse side by the named shipper to show that the document is freely negotiable to any bona fide holder or to a declared consignee nominated by the buyer at a later date. It is prudent that the name of the consignee be stated in the required section at the time of presentation of documents to avoid any ambiguity or confusion regarding title of the shipment.

Other documentation

Certificate of origin: a standard documentary requirement under L/C. It is issued by the local chamber of commerce, usually in the country of origin.

Phytosanitary certificate: a general certification that the goods are free of any specified infestations, issued by the applicable official institution in the country of origin.

Fumigation certificate: a certification that fumigation has been performed by specialist operators or an accredited organization in the country of origin. This is performed in either the warehouse or the actual containers prior to shipment on the vessel. Most cotton producing countries require cotton imports to be fumigated in advance of shipment, although it can sometime be arranged at the port of discharge.

Phytosanitary and fumigation clauses are sometimes certified within the same certificate depending on the payment instrument and its demands. The clauses are often dictated by the L/C wording. It is important therefore to ensure that the clauses meet the precise L/C stipulations.

Weight /packing list: a buyer may demand a listing of the individual gross weights of each bale, known as ‘bale/bale weighing’, or the total weight per container. In other cases a more general list may be acceptable providing a summary of the total number of bales, gross weight, tare and the resulting total net weight of the shipment.

Insurance certificates: are required under a CIF contract. The seller must provide an insurance certificate, issued by a first-class insurance company, showing that insurance has been covered in accordance with the terms of the sales contract. The certificate must enable the buyer to claim any losses direct from the insurance company. The certificate entitles the holder to the rights and

privileges of a known and stipulated master marine insurance policy that may cover a number of shipments. The certificate therefore represents the policy and is transferable with all its benefits by endorsement in the same manner as bills of lading.

Claims

Claims are fairly common in the cotton trade and may result from either technical events or variations in the characteristics of the natural fibre shipped against specific values stated in the contract. Claims seldom resolve themselves and the seller should therefore address any claims at an early stage and respond appropriately.

It is the responsibility of the claimant to evidence claims and to support them wherever possible with documentation, such as independent test results in the case of a quality claim. Time limits often apply. For example, in relation to quality disputes under ICA Rules there are specific timelines for sampling, application for and commencement of arbitration, and dispatch of samples for arbitration. Care should be taken to monitor these time limits and take any appropriate action within the time stated in the contract or applying under a named arbitral association.

Claims should always be documented in writing and held as evidence for use in any subsequent negotiations or arbitration.

It is always better to try and settle claims amicably. However, should this not be achievable recourse to arbitration may be possible and will offer a final remedy.

Scope and validity of an offer or bid

An exporter wishing only to advertise a potential availability at an approximate price uses terminology such as price idea or we offer/quote subject to availability or subject unsold. To the buyer this suggests there is a good chance of purchasing the cotton in question if the indicated price is agreed to. Although the exporter is not bound to sell, the buyer has some reason to be annoyed if the exporter refuses to do so for no obvious reason (e.g. was simply fishing for price information).

With a firm offer, however, the seller is committed to sell, if the buyer accepts the offer, within the validity timeframe of the offer. Sellers must stipulate a time after which the offer lapses. The same applies to bids from buyers: these too must be specific. Subject to immediate reply says that the reply should be immediate, but even immediate is not precise. It is always better to say, for example, subject to reply here by 3 p.m. our time. The choice of time limit depends on the situation of the exporter and the type of buyer to whom the offer is addressed. Exporters who are keen to sell may wish to try various markets at the same time. If they have only limited stocks of the cotton in question they cannot make multiple firm offers and will instead offer subject to availability or subject unsold. Alternatively, they can make firm offers for short periods to individual buyers by telephone or, increasingly, by e-mail. Conversely, they can give a buyer or, more probably, an agent an entire day to work an offer, but the exact time at which the offer expires should always be stated.

Modern communications offer almost instantaneous exchanges, especially through e-mail and electronic commerce, enabling exporters to contact many potential buyers within short periods of time. It is not only the face of trade that is changing, but also the methodology and terminology. What will not change is that acceptance, verbal or otherwise, within the time limit of a firm offer or bid constitutes a firm and binding contract. Disputes can be submitted to arbitration but the best approach is to ensure that the wording of offers or bids is clear and precise.

If a buyer counter bids a lower price against a firm offer this automatically releases the seller. The offer is no longer binding, because the buyer has rejected it by counter offering. If the seller rejects the counter offer the buyer cannot subsequently revert to the original offer – when they countered, that firm offer lapsed – unless, of course, the seller agrees to reinstate it.

Arbitration⁷

General principles and aims of arbitration

Arbitration can be defined as a private, formal and binding process available to contract parties providing a fair and impartial resolution to disputes without undue delay or cost. It produces an award which is enforceable through the courts. The result of arbitration is the issuance of a binding and enforceable award, subject to any appeal.

Contracts should provide a remedy for any disputes that arise during the life of the contract.

Arbitrations are conducted on the basis and existence of an 'arbitration agreement'. In the case of contracts subject to English law this must be evidenced in writing between the parties, either at the time of contract or at some subsequent date. Arbitrations are conducted by people who hold experience and expertise within the trade. They are conducted in private, with the parties agreeing to appoint either a sole (one) arbitrator or each appointing their own arbitrator to act for and on or behalf of that party. Arbitrators are not advocates of their respective parties and must act impartially at all times.

A Tribunal may, as dictated under the rules of any related arbitral association, include the appointment of a chairperson who holds responsibility for the directions issued and who ensures the timely and cost-effective conduct of proceedings.

An arbitration clause should clearly state the arbitral centre to be used. There are different centres of arbitration, located in different countries. These include:

- France – Association Française Cotonnière
- United Kingdom – International Cotton Association Ltd
- Germany – Bremer Baumwollbörse Bremen Cotton Exchange
- United States – American Cotton Shippers Association
- China – China Cotton Association
- India – Cotton Association of India

The United Nations Commission on International Trade Law (UNCITRAL) published in 1985 the model law that specifically addresses international commercial arbitration. It provides an arbitration law written in plain language which is easy to understand giving parties access to a valuable tool for arbitration, subject to adoption by the parties.

The model law has been adopted by certain countries, with the exception of England which has its own comprehensive system for arbitration with clear directions stated within the Arbitration Act of 1996. The International Cotton Association Ltd (ICA), located in Liverpool, United Kingdom, provides contract parties with a set of Bylaws and Rules under which a majority (approximately 60%–70%) of the global trade in cotton is transacted and arbitrations conducted.

⁷ Reference to and extracts of the ICA Bylaws and Rules are provided with the kind permission of The International Cotton Association Ltd, Liverpool, United Kingdom. This section is intended as a general guide to assist in the general understanding of formalities and procedures involved at arbitration. The extracts and references are not intended as a definitive expression of the those bylaws and rules and do not take precedence over the ICA Bylaws and Rules which should be consulted in their entirety by application to ICA or online at www.ica-ltd.org.

The following sections will deal specifically with arbitrations and arbitration proceedings conducted under ICA Bylaws and Rules. These are subject to the application of English Law and the Arbitration Act 1996.

Disputes addressed by ICA arbitration

'Quality' arbitration relates to the manual examination and appraisal of certain cotton characteristics. This excludes values that can be measured only by mechanical testing.

'Technical' arbitration deals with all other disputes.

Whatever the dispute, it is important to recognize that there are time limits to comply with in order to validate a party's claim and application for arbitration. For example, in quality arbitrations, arbitration must be commenced within 49 days of the date of arrival of the cotton. Likewise, samples must be drawn within 42 days and dispatched to the place of arbitration within 70 days of the date of arrival of the cotton. Failure to comply with these timelines may prejudice a party's position at arbitration.

Physical or mechanical tested characteristics of the cotton fibre

Arbitration is conducted on actual samples drawn and sealed under supervision of the seller's and buyer's representatives and dispatched to an agreed location for arbitration.

Physical arbitration is arbitration based on fibre values that are possible to identify by physical inspection, namely grade (colour, leaf/trash content, preparation) and staple (length).

Mechanical testing or testing by High Volume Instrument (HVI) or SITC testing provides results on various fibre properties, some of which cannot be identified by manual classification. These include strength, elongation, uniformity, micronaire and maturity. As there is no physical valuation involved this can be placed under the category of technical arbitration, with the arbitrators handling paper certificates.

Technical arbitration – dealing with the written aspects of the contract

Arbitration is normally conducted on the written evidence supplied by the parties. An oral hearing can be requested, but this will be permitted only on the authorization of the tribunal. An oral hearing involves personal representation: one or both parties would attend or be represented by a nominee on their behalf and address the tribunal.

Technical arbitration may involve issues relating to non-fulfilment of a contract or portion of a contract, or breach of any express terms of the contract and conditions, for example late payment of cotton or claims arising during the performance of the contract.

The commencement of arbitration and formalities

When a dispute arises it should be addressed at an early stage. Every attempt should be made to settle the matter in an amicable fashion, perhaps by finding a 'middle ground' where the parties would be content to settle their differences.

No party wants to have to resort to arbitration. A formal and legal resolution to a dispute therefore usually only follows a protracted period of dialogue and exchange. Only when negotiation fails and an amicable settlement is not possible does a party seek recourse to arbitration to resolve the dispute.

A party wishing to commence arbitration proceedings must first send a formal request to ICA advising the details of the respondent and confirm they have sent the respondent a copy of the application. The formal request will include a copy of the contract and, where applicable, a copy of the separate written arbitration clause and any application fee that is due in line with the Rules.

The claimant will nominate its arbitrator, unless both parties have agreed the name of the sole (single) arbitrator, who would then be advised.

ICA can refuse arbitration facilities. This can happen if, for instance, one party has been suspended or refused membership.

Appointment of arbitrators

When a valid request for arbitration has been received, ICA will direct the respondent to appoint its arbitrator within a specific time frame. Should this not be done, ICA will make the appointment.

Arbitrators must be members of ICA at the time of appointment.

ICA appoints a third arbitrator to act as chairperson, who will consult with the other tribunal members and agree and issue directions to both the parties. Directions are usually produced in a standard format. They include such items as timelines for documentary submissions and general comments on proceedings.

Conducting the arbitration

Once all the documents have been received from the parties the tribunal will commence its review of the dispute submissions. If one party, despite repeated requests for submissions, fails to supply any documentation, the arbitration proceeds *ex parte*, i.e. the tribunal makes its award based on the submissions of one party alone.

An oral hearing can be requested in writing by either party. The tribunal has the sole authority to grant or deny the request.

All procedural and evidential matters will be addressed by the tribunal and decided by the chairperson, who will ensure a timely process. Orders may be issued to direct the parties to meet certain schedules. All orders and decisions, along with the arbitration award, will be made by a majority decision of the arbitrators and chairperson. The chairperson has the final decision if the other two arbitrators cannot agree.

Evidence has to be submitted in English. If this is not possible, unless otherwise directed by the tribunal, an official and certified translation must be supplied.

The tribunal may at its discretion call upon the parties to clarify certain issues or supply additional documentation as required to assist in the tribunal's findings.

The arbitration award

An arbitration award is in writing and signed by all the tribunal members. It is dated, and will state the 'seat' of the arbitration (which in the case of ICA arbitration is England). It will also state the latest date that any appeal against the award must be received by ICA.

An award must be clear, complete and unambiguous, ensuring that all dispute issues raised by the parties are adequately addressed and that the findings and

directions are fully reasoned. The directions contained within the award must be capable of performance under the applied time schedules contained within the award directions.

The contents of an award will include:

- Identification of the claimant and respondent;
- Contentions (arguments) of the parties, or those of one party if proceedings are conducted *ex parte*;
- The contract details and any amendments;
- The arbitration clause;
- The history and facts of the dispute including the actions of the parties and the procedures leading to arbitration (including appointment of arbitrators);
- All relevant factors and considerations taken into account;
- The findings and direction (the award) of the tribunal, which must be reasoned;
- Direction on the award for interest and costs;
- The seat of arbitration;
- Latest date of appeal;
- Date and signatures of the arbitrators;
- ICA stamp.

The award is binding and effective when it is stamped by the ICA.

Both parties are duly notified that the award is published and the latest date for appeal. The award will be released only when all fees, costs and stamping charges are paid.

Appeal against an arbitration award

If either party disagrees with the first tier award it can lodge an appeal with ICA within the time limit specified in the award. Once this is done, ICA may demand a deposit against fees, expenses and costs of the appeal. If the appellant fails to pay the deposit, the appeal may be dismissed.

The appellant will send its reasons for the appeal, and the respondent will send its response. Once these formalities have been concluded, a technical appeal committee will be appointed, consisting of members with no involvement in the first tier arbitration. This committee consists of a chairperson (who must be a director or ex-director of ICA when appointed) and four other members.

Either party can object to the committee chairperson or members provided they supply the reasons for their objection and do so within the stated time limits. An objection will be upheld only where substantial injustice may result; if it is upheld a substitute member will be appointed to serve.

The appeal proceedings operate under a standard timetable which allows each party an adequate opportunity to present its case and to comment on that of the other party. Once this procedure is complete and the deadline for submissions has expired, further submissions will be allowed only with both parties' agreement or if the committee consider that substantial injustice would result from not allowing the additional submissions.

The appeal committee will take into account the parties' arguments and any new evidence supplied. It may vary and amend, confirm, or set aside the original award, and will write a new award that covers all the matters presented in the dispute. The new award is binding on the parties.

Failure to comply with an award

If an award is not honoured a party can provide written notice to the ICA directors, who may then circulate such advice to ICA members, registered firms, member associations of the Committee for International Co-operation between Cotton Associations (CICCA), or any other organization or person. The defaulting company will also be listed on the ICA website.

Such information will be circulated on the ICA List of Unfulfilled Awards at the request and responsibility of the reporting party, who indemnifies ICA and its directors for the accuracy of the information and for all liabilities, damages or costs caused by any inaccuracy in the information supplied. Over the years, this circulation has acted as a tool to promote good trading practices in the raw cotton trade.

It is the responsibility of the reporting party to immediately notify ICA if the award is settled, to enable the listed party to be removed from the List of Unfulfilled Awards.

Promotion of good trading practice

It is important to enforce and sustain good trading practices wherever possible. This evidently assists the performance and the satisfactory conclusion of contracts and promotes trade with reliable partners, without which uncertainty and problems may result.

Disciplinary procedures, such as those contained in the ICA Bylaws, are intended to act as a disincentive to any Registered Firm of ICA in circumventing the List of Unfulfilled Awards and trading with a company that appears on that list. All parties should therefore consider the reputation and standing of their proposed trading partner before proceeding with negotiations and to contract.

The European Cotton Rules

Association Cotonnière de Belgique, Association Française Cotonnière (AFCOT), Gdynia Cotton Association (GCA) from Poland and Centro Algodonero Nacional (CAN) from Spain took the lead in a task force aiming at modernizing and harmonizing cotton trading rules. The objective was to adopt a common set of cotton trading rules shared by the greatest number possible, while respecting everyone's identity.

The work began with a comparison of the various rules of each cotton association in order to have a common platform which would take into account the identity and the specificities of each one and would also satisfy the needs of all members of the cotton community, such as producers and exporters.

The work has been facilitated by the fact that the national laws in most countries of continental Europe share a common source: the written law. Written laws are also shared by many African and Asian countries. Based on this common platform, the European Cotton Rules (ECR) is a rule book that enables all parties to know their rights.

The European Cotton Rules were finalized in 2006. They are already in force, and provide protection to all users. ECR offers unique harmonized rules, which have been set up in accordance with CICCA's principle of sanctity of contract.

ECR offers security thanks to rules that have been defined with clarity and precision in order to avoid any uncertainty as to how a contract is to be honoured. ECR guarantees equal treatment to all parties, buyers and sellers, be they producers, ginners, merchants or spinners.

ECR offers flexibility. Each association that adopts ECR can keep some specific rules in an appendix to preserve its identity and specificity.

ECR offers freedom to choose the arbitration chamber to be used by the parties who sign a contract under its rules.

Documentation ('back office')

International cotton transactions are executed by transfer of title rather than by the physical handing over of cotton. Title to goods shipped under contract by sea from one country to another is represented by the bill of lading, accompanied by a set of additional documents, together known as the shipping documents. The document of title for goods already stored in the port or place of delivery under a spot contract can be a warehouse receipt or storage warrant issued by a recognized public warehouse. The only difference between the traditional chain of paper documents and electronic documentation is that the paper is largely eliminated. This is why using electronic documentation is sometimes also called paperless trading. Using electronic documentation does not change the contractual responsibility of the seller or the buyer: the only differences are in how and when documents are issued, and how and when they are made available to the buyer.

Shipping documents must always comply in all respects with the conditions of the contract between the parties. If they do not, a seller may not be paid on time, or, in extreme circumstances, may lose the money altogether. The shipping documents must therefore show or state that they represent the contracted and shipped cotton, that a known series of shipping rules has been complied with, and that they conform in all respects to the sales contract between the parties and to the standard form of contract on which that sales contract is based. Shipping documents must also be presented on time. Nothing is more annoying than late presentation of documents.

Letters of credit

Where payment against a letter of credit (L/C) is stipulated then the seller should obtain full details of the buyer's L/C as soon as possible. This is to ensure that the required documentation is in fact obtainable, that there will be sufficient time to obtain such documentation, and that there are suitable shipping opportunities to the named port of destination within the stipulated period of shipment. Sellers should also ensure that the L/C remains valid for the presentation of documents for at least 21 days after the date of shipment.

Buyers calculate all costs (from FOB through to delivery at final destination) to arrive at the final delivered price, taking into account any extra costs. For example, an origin that usually delivers documents late (i.e. after the vessel has arrived) is penalized, as the buyer will provide for this eventuality in the cost calculation to landed plant. In fact the importer actually saves money by not having to finance the goods for the expected period of time, but if the goods arrive before the documents then serious trouble will arise. If an L/C is demanded, the bid price will be lowered correspondingly to cover the costs. Such a bid will also be lower than that for similar cottons from other origins that do not require an L/C.

Payment: credit policy

Exporters must decide for themselves which payment conditions to accept. They must assess the financial status of their buyers and offer accordingly. Some information can be obtained from bank references that indicate a client's creditworthiness. Although such reports are useful, they cannot provide all the desired information, nor do they place any responsibility on the bank that issues them. Exporters using borrowed working capital are usually subject to stringent conditions concerning the buyers they can sell to, and on what payment conditions.

When entering into contracts and deciding on payment terms, sellers should investigate the identity of their buyers. International trading groups often work through foreign and local subsidiaries whose commitments are not necessarily guaranteed by the parent firm, even though they may trade under the same or similar names. When in doubt a seller can demand a guarantee from the parent firm that it accepts responsibility for contracts with a given subsidiary.

In some countries the monetary authorities dictate payment policy for exports, for instance by insisting that all exports must be covered by L/Cs to avoid possible loss of foreign exchange. This kind of blanket regulation results in some of the world's largest corporations with impeccable credentials being asked to establish L/Cs.

Shipping advice

As soon as the required information is available, the seller must advise the buyer about certain specific details of the shipment. The buyer is entitled to receive advice of shipment or delivery, or advice of delayed shipment or delivery, or advice of *force majeure*. For a shipment on terms other than CIF (which the seller insures), the shipping advice enables the buyer to insure the shipment and either to make the necessary arrangements to receive it at the port of destination or (where the bill of lading allows such a choice) to declare an optional port of destination in time for the shipping company to arrange discharge there.

It is not uncommon for buyers of cotton to have proper advice of shipment, within contract terms, but still not know the name of the vessel that will deliver at the final port of discharge because the name of the transshipment vessel is not always known at time of loading. Larger buyers working on just-in-time supply require carriers to inform them directly by e-mail, within a given time limit, of all transshipment arrangements including the name of the mainline vessel and its estimated time of arrival (ETA) at destination.

Delayed shipments

The seller must advise the buyer of delayed shipment as soon as, for example, it becomes aware that a vessel may not load within the contracted period because of problems connected with the operations of the vessel itself such as a delay on the inbound voyage. The seller must also show, using independent documentary proof, that a late shipment is not its fault. Delays in shipment usually affect buyers adversely. Conversely, delayed receipt of buyers' L/Cs affect sellers adversely.

Occasionally a problem of a much wider scope and of a more serious nature arises that prevents the seller and other shippers from shipping within the contracted period. In addition to sending the notification of delayed shipment as soon as this becomes evident, under certain circumstances the seller may be able to claim *force majeure*. The effect of both an advice of delayed shipment (or delivery) and an advice of *force majeure* is initially to extend the period allowed for shipment. Experienced exporters know that quick and frank admission of shipping problems usually helps them to reach an amicable settlement with their buyers. Failure to ship is bad enough, but failure to keep buyers informed is even worse as it prevents them from making alternative arrangements in time.

Upon completion of shipment and negotiation of the documents (the bill of lading being paid and in the hands of the consignee) any delay in arrival will become the buyer's or consignee's prerogative and it will be up to them to claim on the shipping line.

The bill of lading

A bill of lading (B/L) is firstly a receipt – the carrier acknowledges that the goods have been received for carriage – but it is also evidence of the contract of carriage. The contract commences at the time the freight space is booked. The subsequent issue of the B/L confirms this and provides evidence of the contract, even though it is signed by only one party: the carrier or its agents. A B/L is also a transferable document of title of goods. Goods can be delivered by handing over a B/L provided the shipment was consigned ‘to order’ and all the subsequent endorsements are in order.

The carrier’s responsibility commences on the physical acceptance of the goods for carriage. If this occurs at an inland point, a combined transport B/L will be issued. If the handover is in a port then a port-to-port bill of lading will be issued.

The B/L usually contains:

- The name of the seller at origin (the shipper); the name of the buyer (the consignee); and, specified by the buyer, the name of the party to whom delivery is to be made and who is to be notified of the arrival of the shipment (the notify address).
- The unique number of the B/L, the name of the vessel, the port of loading, the destination, and the number of originals that have been issued.
- Details of the cargo and whether shipped LCL/LCL or FCL/FCL, together with the container and seal numbers, where shipment is in containers.
- A statement that the cotton is on board *or* shipped (i.e. not simply received by the shipping company for shipment), and that there is no record of damage to the cotton (a clean B/L), and the date of on-board shipment. A ‘received for shipment’ LCL B/L may be acceptable if this has previously been agreed by the buyer. An on-board B/L is a bill that is signed by the captain of the vessel or the captain’s agent when the cotton has been loaded on the ship.

Bills of lading are issued in sets of identical originals, normally two or three, with a variable number of non-negotiable copies for record purposes only. Each original can be used independently to claim the cotton shipped, although not everyone holding an original bill of lading will automatically be handed the goods by the shipping company at destination. Who is allowed to claim the goods depends on how the bills are made out.

Under a combined transport bill of lading the carrier accepts responsibility, subject to the normal stipulations in the B/L, for the whole carriage, inland and marine, from door to door, or from door to container yard or container station. The carrier arranges both the marine and the inland transport. An intermodal B/L or combined transport document is a negotiable document issued by a water carrier after receipt of container of cotton on board a rail car or other transport equipment. A typical intermodal B/L might cover the shipment of containerized cotton from the ginnery or the warehouse to a spinning mill overseas. It is customary to issue the ocean B/L or intermodal B/L in three originals made out to order.

Sellers must provide shipping documents in good time (including a full set of clean on board B/Ls, i.e. bills stating that the goods were received on board ship in apparent good order), enabling the buyer to clear the goods upon arrival. Failure to provide documents in time will incur demurrage and other costs, and could even in extreme cases lead to cancellation of the contract.

Title to and endorsement of a bill of lading

Since the B/L is a title document, in theory anybody holding the B/L can take possession of the cotton. The B/L could be issued 'to order of ___', leaving the foreign bank insert the name of the buyer after payment has been received, but this is a very dangerous practice!

When B/Ls are made out, or endorsed, to a named consignee, then only that consignee can take delivery of the shipment. A B/L made out to a named consignee can be endorsed only by that consignee, not by the shipper. Once a consignee has been named, the original shipper no longer has any power to alter the B/L in connection with title to the shipment.

If the consignee is not known at the time the shipper instructs shipment on a particular vessel, then the B/Ls may also be made out to order. In this case, only the party to whom they are endorsed with the words 'deliver to ___' or 'deliver to the order of ___' can take delivery. This endorsement is made by the shipper named on the B/L. Occasionally buyers stipulate in their shipping instructions that the goods be consigned to order.

A bill of lading is a negotiable instrument and can be passed from a shipper through any number of parties, each party endorsing it to assign title to the next party. The only condition is that title can be assigned only by the party shown on the bill as having title at the time. Any failure to respect this condition breaks what is known as the chain of title; all purported assignments of title after such a break are invalid. Before paying for documents buyers will therefore carefully examine the B/L to see that they are named on it as consignee, either on the face or on the reverse in an endorsement. In the latter case, buyers will also make sure that the endorsements show an unbroken chain of title through to them.

There is one exception to the general rule that a consignee must be named on a B/L to take delivery of a shipment. This is when the bill is a bearer bill. In this case, anyone holding (or bearing) the bills (or one bill of the set) can take delivery. Bills are considered bearer bills when the word 'bearer' is entered in the space marked 'consignee' when the bills are first made out. Alternatively a title-holder can endorse the bills with the words 'deliver to bearer', or a named title-holder endorses the bills in blank (by stamping and signing them without naming any other party in the endorsement). Although this may be simple and convenient, it means that anyone who obtains all or any of the originals (including a thief or a buyer who has not yet made payment) can take delivery of the shipment. Bills of lading are therefore usually made out to or endorsed to a named consignee.

The greatest security of all is afforded by issuing or endorsing a B/L to a buyer-nominated bank, with an instruction to the bank to endorse and hand the B/L over to the buyer when, and only when, payment has been made.

Dispatching bills of lading

Because in theory each original B/L in a set can be used to claim the goods at destination, a buyer will want to be in possession of all the originals in a set before making payment. Documents are often sent in two dispatches, with the B/Ls split between them, simply to minimize the risks of all of them being lost or delayed. Only when the buyer has received both dispatches will payment be made, unless the first contains a bank guarantee for any missing B/L. Many exporters use courier services and send all documents at once.

If a B/L is lost, or does not arrive in time for the buyer to take delivery (e.g. when transit times are short), then the carrier will usually be able to assist by delivering the goods against receipt of a guarantee. The guarantee safeguards

the carrier in case the claimant is not the rightful owner of the goods. Wrongful delivery would constitute a breach of contract. The carrier will therefore insist on a letter of indemnity (LOI) from the buyer, backed by a bank guarantee with wording that meets the carrier's specifications, usually for an amount of 150%–200% of the actual CIF value of the goods, valid for one to two years. Although there is no express time limit beyond which the holder of a B/L can no longer claim the goods, a guarantee good for one or possibly two years should adequately cover the carrier's obligations. However, carriers are not obliged to deliver goods against guarantees.

Certificates of origin

Certificates of origin are issued for every international shipment of cotton from producers to consumers.

Insurance certificates

Under a CIF contract the seller must provide an insurance certificate, issued by a first-class insurance company, showing that insurance cover has been arranged in accordance with the terms of the sales contract. The certificate must enable the buyer to claim any losses direct from the insurance company.

The certificate entitles the holder to the rights and privileges of a known and stipulated master marine insurance policy that may cover a number of shipments. The certificate therefore represents the policy and is transferable with all its benefits by endorsement in the same manner as a B/L.

Other certificates

There are an increasing number of other certificates available for special contractual requirements. Some, such as weight and quality certificates, are supplied by recognized public or private organizations in the country of origin, and have various formats. Others, such as phytosanitary and fumigation certificates, are often supplied on application by government bodies in a set format prescribed by local law and regulations. The variety of formats available for special-purpose certificates is so great that it is not practical or useful to discuss them here. Shippers should be familiar with the format of local certificates, and should investigate their availability and cost before entering into any contractual obligation; otherwise they may be unable to supply a document at all or may require a price increase to cover costs.

Missing and incorrect documents

In principle a set of shipping documents made up of some documents and some guarantees can be acceptable, and it is possible for payment to be made and delivery to a buyer to take place even though no original documents have passed between seller and buyer. But if the absence of documents prevents the importation of a shipment, buyers will not make payment on the basis of a guarantee as they will be unable to gain access to the shipment. While bank guarantees from seller to buyer are generally acceptable for missing contractual documents, guarantees for missing B/Ls must be made out to the shipping company and forwarded to the buyer for use. Shipping companies provide their own pre-printed guarantee forms for this purpose.

A buyer may also accept the seller's personal guarantee for missing documents without a bank's involvement. The seller may take steps to rectify errors in documents, especially when the documents relate to prompt landing and importation of a shipment (e.g. B/Ls) and when the time saved by amending them on the spot either benefits the buyer or prevents charges to the seller. The

buyer can give the B/Ls to the shipping company's agent at destination, who will amend them on receipt of authority from the seller via the shipping company's agent at the port of shipment.

Occasionally an entire set of documents is lost or destroyed in transit. The shipping company can then be requested to issue duplicate bills in return for an unlimited bank guarantee as indemnity against possible future liability to a holder of the supposedly lost documents. Since 1 July 2007, according to UCP 600 article 35 (Uniform Customs and Practice for Documentary Credits), the courier risk is automatically covered by the issuing bank.

As far as incorrect documents are concerned, obvious clerical errors that do not materially affect a document do not entitle a buyer to delay or refuse payment. If mistakes invalidate a document or affect its reliability, the document is regarded as a missing document and a guarantee can be submitted in its place. The document itself is then returned for re-issue or amendment by the seller.

Electronic paperwork

Paperwork – what paperwork?

Shipping a bale of cotton from A to B can be a pretty daunting affair to someone new to the business. Whether 1 container is shipped or 50 containers, the amount of paperwork remains the same. A typical shipment requires paperwork consisting of:

- Original and copy commercial invoices;
- Originals and copy bills of lading;
- Original and copy certificates of origin;
- Original and copy phytosanitary certificates;
- Original and copy fumigation certificates;
- Original packing list;
- Original bale-by-bale weight list;
- Letters to insurance companies confirming shipment details;
- Copy of courier receipts confirming dispatch of documents.

Different countries have different customs formalities. China may require 3 copies of each document, while Bangladesh may call for 12 copies of each. It seems there is just no getting away from paper.

Why do we need this amount of paper?

The vast majority of internationally traded cotton still requires paper documentation. Concluding the purchase or sale transaction in the first place may be conducted by telephone, fax, e-mail, electronic trading platforms or even in person, but such agreements have to be documented in writing. With cotton being a globally traded and transported commodity, each country has its own formalities that require compliance in order to import, ship, rail or truck, and export.

Take a bird's eye view of a typical transaction. Imagine we have 500 tons of Malawi cotton purchased from a local Malawi ginner. This ginner has sold its

cotton via a European merchant, who in turn has sold to a Chinese buyer in Shanghai. Ignoring for the time being the specific documents required at this stage, let us review the movement of the physical goods required:

Day 1 – Cotton is loaded in Malawi on to trucks at the ginner's warehouse.

Day 2 – Trucks depart Malawi with instructions to drive to South Africa.

Day 3 – Trucks arrive at the border between Malawi and Mozambique. Customs inspection and clearance is required into Mozambique.

Day 4 – Trucks arrive at the border between Mozambique and Zimbabwe. Customs inspection and clearance is required into Zimbabwe.

Day 8 – Trucks arrive at the border between Zimbabwe and South Africa. Again, customs inspection and clearance is required to bring goods into South Africa.

Day 9 – Truck arrives at bonded warehouse in Johannesburg for unloading.

Day 10 – 500 tons of cotton stuffed into 40 foot shipping line containers for transport to seaport.

Day 11 – Containers loaded on to rail cars in Johannesburg for rail movement to Durban.

Day 12 – Containers arrive at the port of Durban and moved into stacks ready for ocean vessel to berth.

Day 14 – Vessel calls at port to load containers on board.

Day 15 – Vessel sails from South Africa.

Day 22 – Vessel calls at transshipment port of Singapore to transship containers on to feeder vessel calling at Chinese ports.

Day 24 – Feeder vessel collects containers at Singapore and sails to Shanghai.

Day 26 – Vessel arrives in Shanghai and unloads goods.

Day 27 – Receiver clears containers from the port authority and trucks full containers to its interior warehouse.

Day 28 – Containers arrive at interior warehouse and cotton is unstuffed.

Day 29 – Empty containers returned to shipping line.

Every one of the above processes requires some form of document to allow the movement of goods to continue to its next stage. It is easy to appreciate that, having to deal with paper documentation, and with the number of borders and customs formalities to comply with, complexities and delays are all too often experienced by seller and buyer.

It is therefore highly appealing to implement electronic paperwork to ease the flow of goods.

How can electronic paperwork assist me?

Banks, shipping lines, transport companies and others in the supply chain are all very interested in introducing electronic security and the standardizing electronic trade documentation. Some organizations have taken the initiative and have had electronic platforms implemented for some years now. Global shipping lines are probably at the forefront in this regard. A number of ocean carriers have fully integrated platforms that electronically monitor the initial freight booking received from the trader, automatically release containers at origin, electronically send notification of sailings and issue B/Ls when cargo is

loaded on board their vessels, fully track the carrier's containers through transshipment ports, prepare and send arrival notifications to the cargo receiver at the port of discharge – not to forget the raising and collecting of freight invoices.

For a trader, incorporating such electronic platforms results in immediate benefits. They provide visibility, accuracy, predictability and security as well as staff efficiency, reduced L/C presentation times and quicker capital turnaround. For many sellers, the time lapse between actual shipment, execution of the physical dispatch, processing of paperwork through banking channels and the receipt of funds can take as much as 15–25 days. By incorporating a paperless electronic system, those time frames can be reduced quite significantly.

Unfortunately, while work is being done by some in the supply chain, not all sectors are taking the required steps at this time. To return to the example of exporting Malawi cotton to China, it is understandable that with the movement from one country to the next along the chain it is virtually impossible to standardize customs formalities and paperless transactions. Sub-Saharan African countries are continually attempting to make customs procedures more uniform and therefore more efficient, but each border location has its own quirks and the procedures have yet to become totally transparent.

Other continents too face problems, and much work is needed to provide stability to those areas in order to avoid port congestion, lock-outs and political unrest. Recently, major congestion in the port of Chittagong, Bangladesh, has resulted in most feeder operations incorporating port congestion surcharges for inbound cargo, because there are up to 12 vessels at any one time sitting outside the port for more than 7 days waiting to berth. No matter how good the electronic systems are, there is always the threat of external factors disrupting the physical movement of cargo and document flow.

The electronic revolution

Not so long time ago, all shipping documentation had to be prepared manually without the use of a computer, and telex communication was the only form of liaison with origin countries to obtain shipping information. Then fax machines were introduced, providing data in a fraction of the time, today we cannot imagine life without e-mail – how did we ever cope!

The cotton trade has seen the introduction of the electronic contract brought in by the ICA as well as other trade association bodies. Today, 97% of L/C transactions are sent by electronic SWIFT, banks now forward these L/Cs by e-mail to the beneficiary instead of by post, freight bookings are made electronically, and B/Ls are produced immediately the cargo is loaded on board. There are also e-trading companies, but while they bring buyers and sellers together electronically, manual paperwork still has its place to bind the agreements and shipments between the trading parties.

The cotton industry was excited about the introduction of the 'Bolero' system, which promised an electronic revolution in the way international trade was transacted. As well as the electronic transmittal and negotiation of L/Cs, the EWR system in the United States allows the trade to buy and sell cotton electronically at the touch of a button.

Over the last five years, the major companies have utilized their huge resources in developing bespoke systems which they encourage their own customers to use. International banks, with their enormous client base across all traded commodities, have developed in-house systems. These developments hardly encourage straight through processing (STP), in which information that can be

recognized by participating systems can be transferred and data read from computer to computer without the need for user verification and subsequent re-entry of data.

What a giant leap forward it would be for all companies in the supply chain to incorporate systems that talk to each other. Perhaps the different applications will be brought together, as banks have done with SWIFT, but we are not there just yet.

The electronic revolution has certainly made an impact on the cotton trade, and those in the trade already using these platforms have seen a significant gain in their productivity and fast turnaround times for their capital.

But will electronic paperwork really make a difference to both large and small traders in the cotton industry? Absolutely! Banks, warehouses, shipping lines, chambers of commerce, government departments and trade bodies are all moving into the electronic age. Irrespective of whether they ship 2 or 2,000 shipments a month, exporters can obtain and print their certificates of origin online via the Internet, the shipping line allows the original B/Ls to be printed within the trader's office just hours after the cotton is loaded onboard the vessel, and courier companies have electronic air waybill manifests to evidence and track dispatched documentation. Banks receive electronic documentation to allow them to check compliance and claim for funds from the end-user quicker than receiving manual documentation from the seller. Warehouses provide electronic warehouse receipts for immediate passing of title to the goods between seller and buyer.

The advice is simple – whether you are a one person operation or a multinational, ask the companies in your supply chain what electronic platforms are available for you to incorporate within your business. Although it may not be possible to have one all-encompassing trading platform across the entire supply chain, the advantages already in the marketplace will allow greater efficiency, control and cost savings.

How secure is electronic paperwork?

We have all heard horror stories about computer hackers getting access to bank databases and stealing customers' identities and bank accounts, and the same scenario is possible with electronic documentation. International trade finance banks already take huge precautions with shipping documentation to check the apparent authenticity, and the electronic transmission of data is the next challenge.

There appears to be a return to bespoke systems in which the shipping lines, government authorities, warehouses and others organizations in the supply chain rely mainly upon their internal system controls and security. While this has its advantages, it shows that the collection of electronic paperwork under one core umbrella is not currently workable on a global scale. To marry up a Malawi certificate of origin with a South African-loaded B/L and present both e-documents electronically through a European bank under L/C negotiation is certainly a challenge!

It was only 20 years ago that telex ticker-tape was the main form of cross-border communication and we had never heard of e-mail. Imagine where we will be 20 years from now. Just ensure you go along for the ride!

Selection of screenshots for electronic documentation

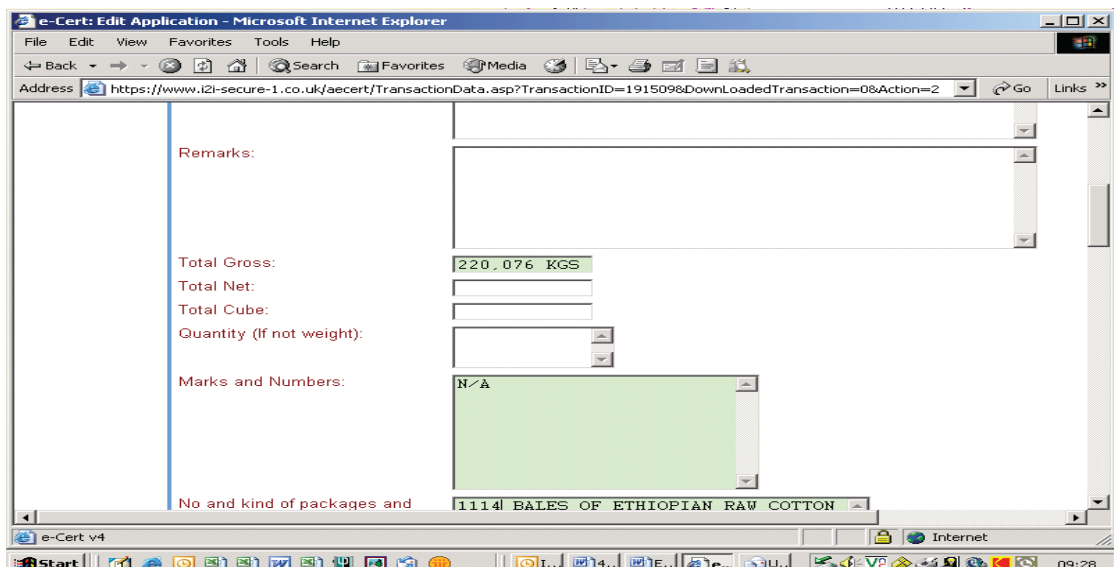
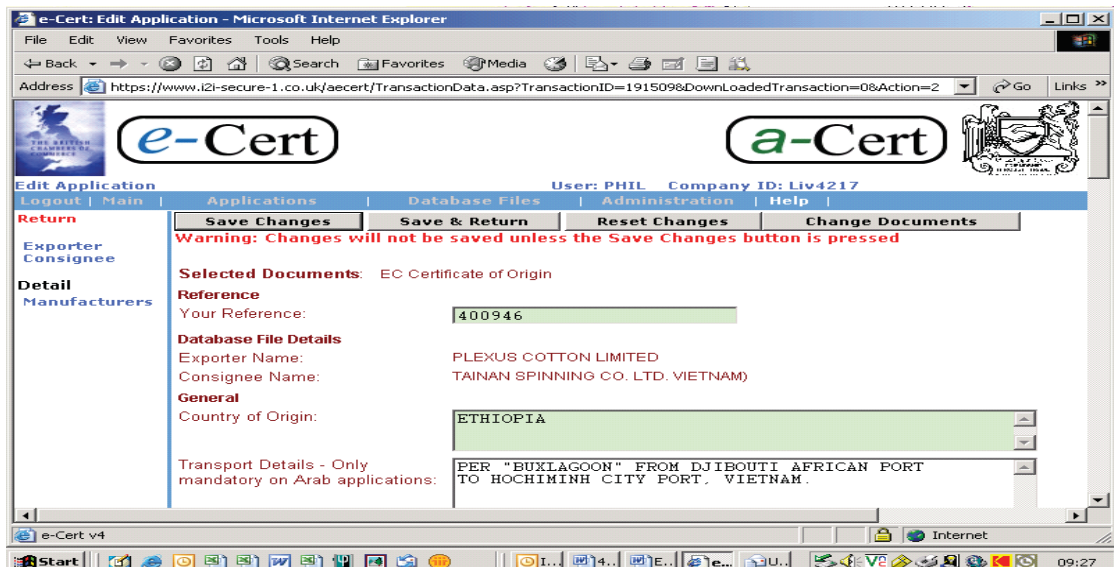
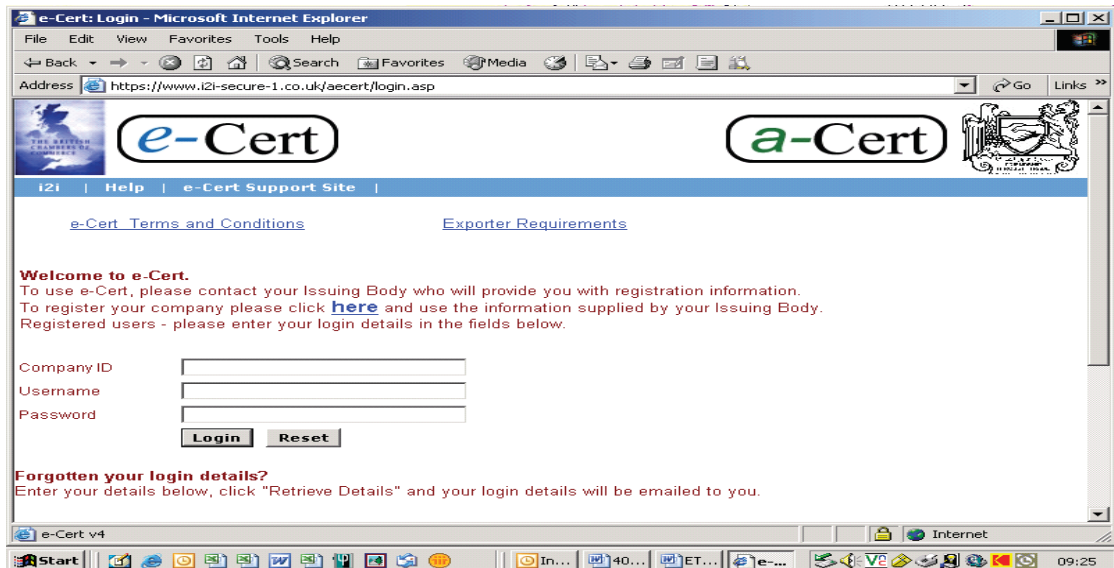

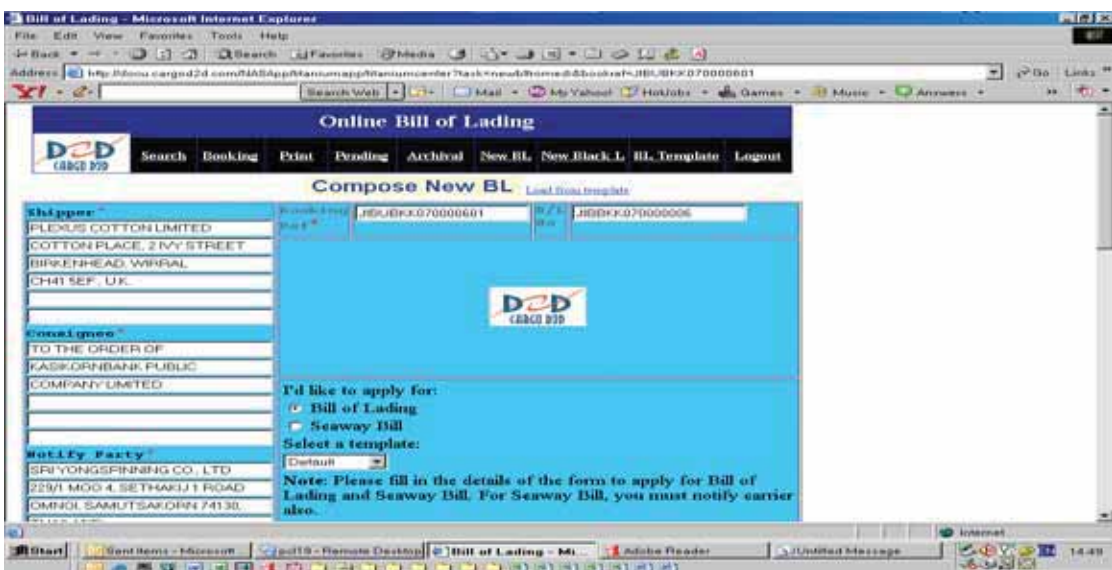
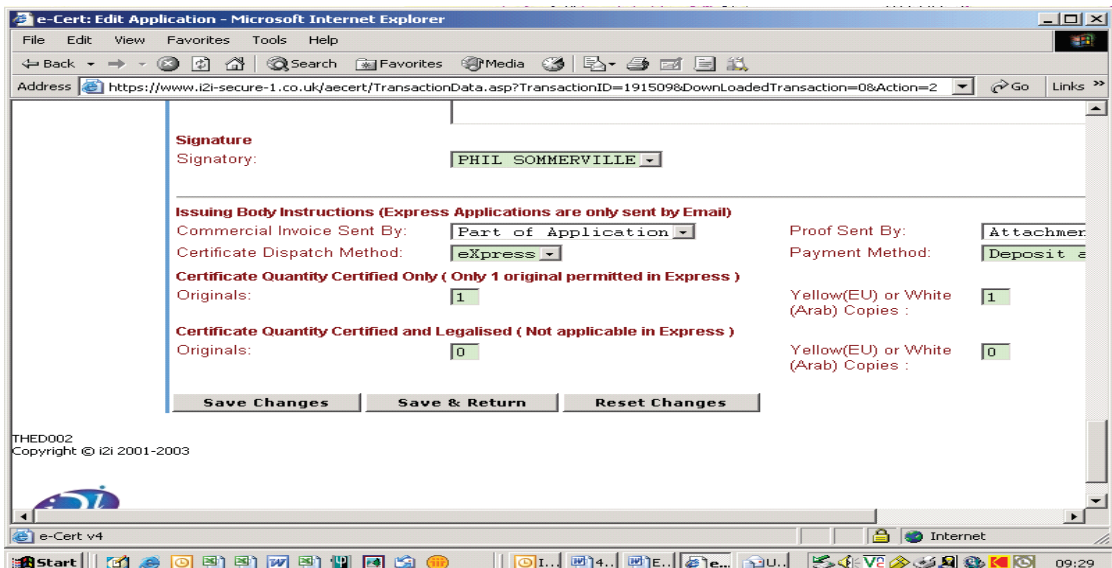
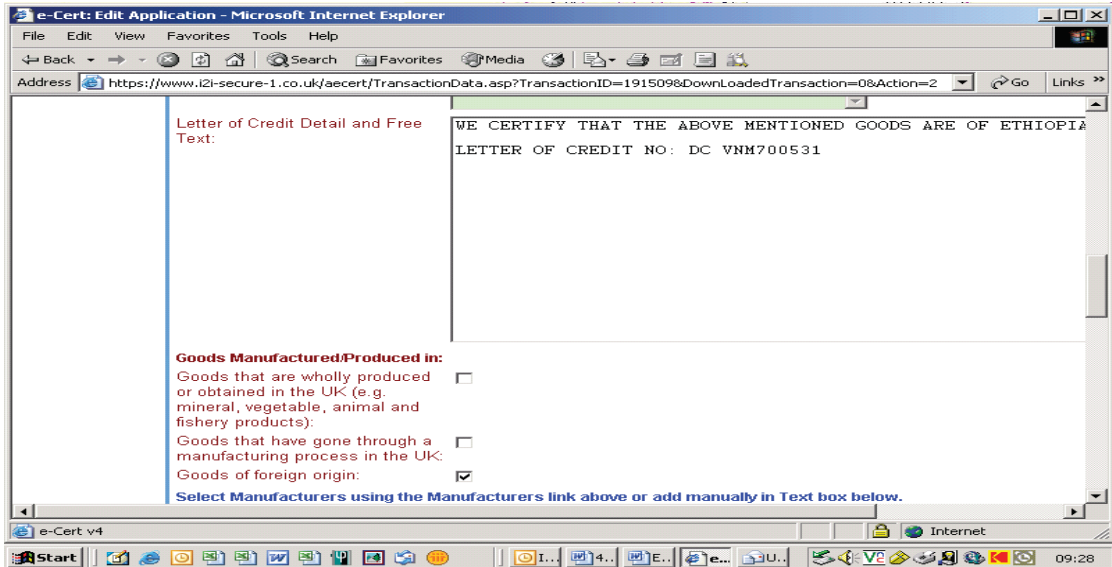

Bill of Lading - Microsoft Internet Explorer

Address: http://foc.cargo321.com/FA5App/Planum/app/PlanumCenter?task=new&from=di&bookref=JBLUBK070000601

Notify Party
 GRI YONGSPIN-INPG CO., LTD
 229/1 MOO 4, BETHANGU 1 ROAD
 OMOLO SAMUTSAKORN 74130
 THAILAND

Seaway Bill
 Select a template:
 Default

Note: Please fill in the details of the form to apply for Bill of Lading and Seaway Bill. For Seaway Bill, you must notify carrier also.

Pre-carriage Vessel Name	Pre-carriage Voyage Number	Vessel Name	Voyage Number
		BUXLAGOON	YBL016
Port of Loading	Port of Discharge	Place of Receipt	Place of Delivery
DJIBOUTI	BANGKOK	DJIBOUTI	BANGKOK
AFRICAN PORT	PORT, THAILAND	AFRICAN PORT	PAT PORT, THAI

Originals: 1

Shipper's load and count, said to contain:

Booking Representative: _____ Additional Info

Line Item 1 of 1 << >> Insert Delete Edit Container Total _____ containers

Bill of Lading - Microsoft Internet Explorer

Address: http://foc.cargo321.com/FA5App/Planum/app/PlanumCenter?task=new&from=di&bookref=JBLUBK070000601

Booking Representative: _____ Additional Info

Line Item 1 of 1 << >> Insert Delete Edit Container Total _____ containers

Marks and/ Numbers	Description of Goods	Gross Weight (Kilow)	Measurement (cu/mtres)
	549 BALES ETHIOPIAN RAW COTTON SHIPPED ON BOARD " BUXLAGOON" ON 07TH MAY, 2007 AT DJIBOUTI, AFRICAN PORT. FREIGHT PREPAID L/C NUMBER: ML07010757	104,960	

Style of formatting in the BL: Align container no with cargo desc. Preview

Freight Charges

FREIGHT PREPAID	Number of Containers/Packages (in words) FIVE FORTY FOOTER CONTAINERS ONLY
	Shipped on Board Date (dd/mm/yyyy) 08/05/2007

Bill of Lading - Microsoft Internet Explorer

Address: http://foc.cargo321.com/FA5App/Planum/app/PlanumCenter?task=new&from=di&bookref=JBLUBK070000601

ON 07TH MAY, 2007 AT DJIBOUTI,
 AFRICAN PORT.
 FREIGHT PREPAID
 L/C NUMBER: ML07010757

Style of formatting in the BL: Align container no with cargo desc. Preview

Freight Charges

FREIGHT PREPAID	Number of Containers/Packages (in words) FIVE FORTY FOOTER CONTAINERS ONLY
	Shipped on Board Date (dd/mm/yyyy) 08/05/2007
	Place of Issue LONDON
	Date (dd/mm/yyyy) of Issue 08/05/2007

1st ORIGINAL

In Witness Whereof this number of original Bills of Lading stated above all of the same and date one of which being accomplished the others to stand void.

Submit Save

EUROPEAN COMMUNITY CERTIFICATE OF ORIGIN

Issued by: HANAM COFFEE LIMITED, 11111 STREET, HANOI, VIETNAM

Destination: UNITED KINGDOM OF GREAT BRITAIN

Origin: VIETNAM

Product: 100% ARABICA COFFEE BEANS

Quantity: 20000 kg

Value: USD 200,000

Signature: Martin Fahidi, AUTHORIZED SIGNATORY

Stamp: Liverpool Chamber of Commerce & Industry, ELECTRONIC CERTIFYING STAMP, 18 Aug 2007, Certificate Number: DB 122048

Edit Container

Container Number	Seal Number	Container ISO	Container	Gross Weight (Kilos)	Measure (in meters)
PC1400000	4001400	40 HC			
PC1400011	4001401	40 HC			
PC1400042	4001402	40 HC			
PC1400043	4001403	40 HC			
PC1400044	4001404	40 HC			
PC1400045	4001405	40 HC			

Logistics

Freight

The total freight cost of exports, which is the cost of moving cotton from the point of origin to its final destination, comprises interior freight from gin yard or interior warehouse via land transport (rail or truck) to ocean shipping port, ocean freight from the shipping port to the disembarkation port, and delivery to the final destination (usually a spinning mill, sometimes a warehouse). Freight is a substantial part of the final delivered-mill price of the cotton. Sales contracts define precisely who is responsible for the payment of freight charges.

Shipping

Basic shipping terms

Break bulk cargo is stowed loose in the ship's hold. The disadvantages of break bulk shipping are numerous: the goods can be exposed to the weather during loading and discharge; the bales can be torn; there is a risk of contamination from other cargo during the voyage. Marine insurance is usually higher for break bulk cargo.

Containerized cargo remains in the container throughout the journey, often to the final inland destination. Container transit is faster, more efficient and more secure than break bulk. The cotton can be loaded in the container at the gin and transported all the way to the overseas spinning mill. Modern container vessels spend only short periods in port as all cargo is assembled before arrival, and container handling can proceed irrespective of weather conditions. Strict schedules can be maintained, and turnaround times are shorter.

Liner services are regular, scheduled shipping services between fixed groups of ports that operate regardless of cargo availability. Tramping vessels, on the other hand, make irregular, opportunistic calls at ports when cargo is available.

Unless specifically stated to the contrary, all cotton contracts automatically stipulate that shipment will be by liner vessel, operated under a regular, scheduled service. A small percentage of cotton, usually from and/or to non-standard locations may be transported under 'charter terms'. In theory, vessels can also be chartered for larger tonnages but chartering is a complex business and conditions for each charter must be negotiated individually. Shipment on chartered vessels is usually arranged by importers.

Conferences are groups of ship owners that offer regular sailings by guaranteeing the number of vessels that will be available during the year between different ports and the schedules that will be maintained. Most scheduled ocean liners probably operate under liner conferences (known simply as conferences). Conferences schedule and guarantee sailings to and from an agreed range of ports, thereby eliminating duplication among their members. The system benefits both sellers and buyers because freight rates are fairly stable, schedules are published well in advance, and regular and dependable services are provided. Conference vessels are usually of good quality and the operators normally have ample experience of carrying cotton.

The discontinuation in October 2008 of the European Union's block exemption from anti-trust rules for shipping line conferences means that shipping lines will have to find some other way to group themselves.

Vessels belonging to non-member shipping lines are called non-conference vessels. Such vessels may nevertheless also operate on pre-arranged schedules. On some routes they provide the only regular competition to the conferences.

Vessel sharing arrangements (VSA) or alliances are eroding the former dominance of the traditional conferences. In VSA, several carriers offer a joint service by agreeing a frequency and capacity from and to certain ports. The lines share the vessels that each contributes, but each carrier markets and sells freight space on an individual basis. Individual freight contracts can still be negotiated with each line and depending on the space available buyers can also nominate a choice of carriers for the goods.

Shipping hubs and container feeder vessels are becoming increasingly important as the shipping industry evolves to meet the demands of globalization and the proportion of bigger vessels in world fleets is growing. Larger vessels call only at ports with the required deep water offering both the cargo and the mechanized capability to handle it quickly and efficiently. Smaller ports increasingly feed cargo to the nearest regional hub.

Transshipment means that the first vessel discharges at an intermediate port and the goods are reloaded on to another vessel to the final destination. This is increasingly frequent as shipping companies rationalize operations. In particular, the use of containers has encouraged the development of shipping hubs: larger or more central ports that are fed containers from outlying ports by smaller vessels for loading on to large container vessels.

Shipping abbreviations and terminology

AI (all inclusive).

All in rate. Freight rate that is inclusive of all surcharges and extras.

ARB (arbitrary charge). Charge for added expense, such as transshipment charges or ice-breaking charges.

BAF or FAF (bunker adjust factor, or fuel adjustment factor or surcharge). Extra charge applied by shipping lines, or set by liner conferences on behalf of their members, to reflect increases in the cost of fuel, which are beyond the control of the carrier. This surcharge is expressed either as an amount per freight ton or as a percentage of the freight.

CAF (currency adjustment factor). Surcharge applied to freight rates by shipping lines or set by liner conferences on behalf of their members, to compensate for extraordinary fluctuations in currency relationships to the tariff currency, the United States dollar. It is normally expressed as a percentage of the freight and may be negative or positive.

CFS (container freight station). A place where consignments are grouped together (consolidated) as a number of TEUs. It may be accommodated on board a ship.

CY (container yard). Place to which full container loads are delivered by the shipper to the ocean carrier and to which empty containers are returned. A container yard is also be a place where containers can be parked, loaded (or stuffed) or unloaded (or de-vanned), picked up or delivered, full or empty.

CY/CY. Container yard to container yard movement of cargo.

CFS/CY. Container freight station to container yard movement of cargo.

FCL (full container load) simply means the seller/shipper was responsible for stuffing the container and the cost thereof. The contents of a sealed container cannot be verified from the outside. The FCL bill of lading simply states 'received on board one container STC [said to contain] X number of bales of cotton, shipper stow and count'. In other words, in an FCL bill of lading the shipping line acknowledges receipt of the container, undertakes to transport it from A to B without losing or damaging it, but does not commit itself as regards the contents.

Freight final. Most standard contracts for the sale of cotton under the terms of CFR and CIF stipulate 'freight final', meaning that any changes in the cost of transportation between the time of entering into the contract and the time of delivery are for the seller's account. Only increases that enter into force after the shipment took place shall be for the buyer's account.

'**House to**', '**container yard to**' and '**door to**' mean loading controlled by the shipper at the place of his or her choice. Whoever books the freight must pay all costs beyond the point of loading and the cost of providing containers at the house, CY or door.

LCL (less than container load) means that the carrier is responsible for the suitability and condition of the container, and the stuffing thereof. The carrier pays for this and then charges an LCL service charge. The bill of lading will state 'received in apparent good order and condition X number of bales said to weigh X kg'. The carrier accepts responsibility for the number of bales but not for the weight. Shipping lines will generally agree to carry cotton as LCL provided the containers are filled or stuffed on the carrier's premises, ideally at a container freight station (CFS). It has become accepted practice in some countries for containers to be stuffed at sellers' premises at their expense, under the supervision of the carrier or the carrier's appointed agent.

ORC (origin receiving charge) is a charge, added to the base freight rate, that reflects the cost of handling cotton from place of origin to on board intermodal conveyance. 'Pier to', 'container freight station to' and 'container base to' mean that the carrier controls the loading. The cotton must be delivered to the carrier at the pier, container freight station or container base.

Point of destination is the exact place where the cotton is delivered to the person who has ordered it, or that person's agent, and where the carrier's responsibility ends.

Point of origin is the exact place where the carrier or the carrier's agent receives the cotton and where the carrier's responsibility begins.

‘**Shipper’s load and count**’ means the shipper is responsible for the contents of the container.

TEU (Twenty-foot equivalent unit). A unit of measurement equivalent to one 20 foot shipping container, used to quantify, for example, the container capacity of a ship, or the number of containers on a particular voyage or over a period of time. It may be the unit on which freight is payable.

THC (terminal handling charge), **TRC** (terminal receiving charge) and **CYC** (container yard charge). Charge payable to a shipping line either for receiving a full container load at the container terminal, storing it, and delivering it to the ship at the load port, or for receiving it from the ship at the discharge port, storing it and delivering it to the consignee.

‘**To house**’, ‘**to container yard**’ and ‘**to door**’ mean delivery to the warehouse or mill yard selected by the person who booked the freight.

‘**To pier**’, ‘**to container freight station**’ and ‘**to container base**’ mean that the carrier will unload (de-van) at the carrier’s warehouse in the port of destination, the container freight station or the container base.

Transit time is the time for goods to be carried from one place to another.

War risk is a surcharge for higher insurance premiums for vessels operating on difficult or dangerous trade routes. Such unforeseen costs are a result of *force majeure* and may be passed on to shippers or buyers, usually at a flat rate per container.

Shipping in containers

Until the 1970s the only available ocean vessels were ‘break bulk’. Nowadays, almost all cotton transported over water is shipped in containers. Shipping cotton bales in containers is a major improvement over the old break bulk method but still involves extensive handling. Cotton can be loaded into containers at a ginnery or warehouse and transported all the way to the spinning mill overseas, saving the cost of loading and unloading cotton during transit.

As transport and freight costs are charged per container, rather than by weight, it is important to fully exploit a container’s carrying capacity. The container **capacity** is the total cube a container can accommodate. The term *cube* often refers to the cubic measurement of cargo. The capacity (i.e. the internal volume) is determined by multiplying the internal dimensions, that is, the product of internal length, width and height. The *rating* is the maximum gross mass (or weight), that is, the maximum permissible weight of a container plus its contents. The *tare mass* is the mass (or weight) of an empty container. The *payload* is the maximum permitted mass (or weight) of payload, including dunnage and cargo securement arrangements that are not associated with the container in its normal operating condition.

Therefore, $\text{payload} = \text{rating} - \text{tare mass}$.

The most widely used type of container is the general purpose (dry cargo) container.

Container capacity (of ships, ports, etc.) is measured in 20-foot equivalent units (TEU). A TEU is a measure of containerized cargo capacity equal to one standard 20 ft (length) × 8 ft (width) × 8.5 ft (height) container. In metric units this is 6.10 metres (length) × 2.44 metres (width) × 2.59 metres (height), or approximately 39 cubic metres. Most containers today are of the 40 foot variety: 40 ft (length) × 8 ft (width) × 8.5 ft (height) and thus are 2 TEU (approximately 78 cubic metres). Two TEUs are referred to as one 40-foot equivalent unit (FEU).

'High cube' containers have a height of 9.5 ft (2.9 metres). The rating of a 20 foot dry cargo container is 24,000 kg (52,900 lb), and that of a 40 foot, including the high cube container, is 30,480 kg (67,200 lb).

Standard containers used for cotton shipping are usually 40 foot boxes containing about 19.5 tons of baled cotton (net weight), typically between 80 and 90 bales. This may vary greatly depending on the various origins and sizes of the bales. Twenty foot containers are also used occasionally for cotton shipping. Bales are usually brought into their packing position using a forklift truck with bale clamp, and they are packed with their narrow, curved side in the direction of the longitudinal axis of the container.

Ocean freight rates

During the last three decades, seaborne trade of cotton followed the general trend in maritime transport of dry cargo, shifting from conventional ships to container ships. The rapid growth of the container fleet was accompanied by a concentration among shipping companies and an expansion in the share of larger vessels. The world cotton industry benefited highly from containerization, which led to shorter transit times and lower transportation costs.

Ocean freight is nowadays usually quoted as a lump sum per container, regardless of the payload or contents. Containers are usually shipped under FCL/FCL conditions (loading and discharge costs are not included in the freight rate). The cost of loading and discharging containers varies between container terminals and between shipping lines, sometimes considerably.

Freight rates are quoted in United States dollars. Freight rates are governed by factors more numerous and complex than the distances involved, and they fluctuate all the time with demand and supply, currency changes, oil price changes, etc. Depending on the routes, freight rates for cotton exports would range between \$20 and \$120 per ton (between 1 and 5 cents per pound).

Freight charges are of great importance to producing countries, because the real cost of raw cotton for the spinner is the price 'delivered mill'. If cottons from country A and from country B are used for the same purpose, the two origins can be substituted and should therefore be priced the same. If the ocean freight from country A is 1 cent per pound higher than the freight from B, then the FOB price for A should be 1 cent per pound lower to match the landed cost of B.

Freight rates used to be set by the so-called steamship conferences. The conference members would agree among themselves to charge fixed freight rates from certain origins to certain destinations. There were also carriers who did not belong to a conference (non-conference carriers), usually charging lower than conference rates. The conference system gradually fell apart during the past decade. It is now customary for exporters and carriers to negotiate individual freight agreements with shipping lines, sometimes on a worldwide basis. Shipping rates are based on volumes booked by the exporter during a certain time period with the carrier. Thus, as actual freight rates are not publicly known, many bills of lading simply state 'freight as per agreement' or 'freight payable at destination'.

Ocean freight includes variable elements beyond the control of shipping companies. The most important are the cost of fuel and exchange rate fluctuations. Carriers may offer fixed base freight rates for the entire cotton marketing season by having the most volatile components of the freight rate stated in the form of adjustment factors.

Ocean freight rates are usually calculated on a per-container basis, using the following formula:

$$\text{Container rate} = \text{container rate} + [\text{container rate} \times (\text{CAF})] + \text{THC} + \text{BAF} + \text{ARB}$$

Cost distribution between seller (S) and buyer (B)

	FOB	CIF/CFR	FOT
Loading at seller's premises	S	S	S
Inland transport (from the named place)	S	S	B
Trade documentation at origin	S	S	S
Customs clearance at origin	S	S	S
Export charges	S	S	S
Loading terminal handling charges (THC)	S	S	B
Ocean freight	B	S	B
Unloading terminal handling charges (THC)	B	B	B

Cotton and fire

Cotton has been transported by ships for many centuries. Especially in the nineteenth century and the first half of the twentieth century, many fires broke out in this cargo. For example, when the steamship City of Montreal caught fire on the Atlantic ocean in 1887 it was reported that 'she was carrying a cargo of 8,000 bales of raw American cotton, and was the 73rd ship with such cargo to catch fire in only 5 months'. The fires were caused by heating (stowage next to the engine room), self-heating and cigarettes thrown away between the cargo during loading. Extinguishing a fire in cotton was very difficult because water does not easily penetrate the compressed bales.

As a result of these fires, the cargo was regulated by IMO (the International Maritime Organization) without a United Nations number (UN number) until 2000; the UN number 3360 was allocated in 2000.

To fit more cotton in a container, the bales have been increasingly compressed since the 1970s. At the beginning of the twenty-first century, tests were carried out on these bales to determine whether the risk of fire was sufficiently low to allow cargo to be shipped as not IMO-classified. The results were very positive, and Special Provision 299 was added to UN 3360.

International Maritime Dangerous Goods (IMDG) code data:

FIBRES, VEGETABLE, DRY (COTTON)

IMO Class 4.1, UN 3360

EmS F-A S-I (Schedules on how to deal with fire and with a spill)

Stowage Category A (means on or under deck allowed)

Ignite readily.

5.2.2.1.2.1 A package containing a dangerous substance, which has a low degree of danger, may be exempt from these labelling requirements. In this case, a special provision specifying that no hazard label is required appears in column 6 of the Dangerous Goods List for the relevant substance. However, for certain substances the package shall be marked with the appropriate text as it appears in the special provision e.g.:

Substance	UN No.	Class	Mark required on bales
Baled dry vegetable fibres in cargo transport unit	UN 3360	4.1	NONE

Special Provision

29 The packages, including bales, are exempt from labelling provided that they are marked with the appropriate class (e.g. 'class 4.2'). Packages, with the exception of bales, shall also display the Proper Shipping Name and the UN number of the substance that they contain in accordance with 5.2.1. In any case, the packages, including bales, are exempt from class marking provided that they are loaded in a cargo transport unit and that they contain goods to which only one UN number has been assigned. The cargo transport units in which the packages, including bales, are loaded shall display any relevant labels, placards and marks in accordance with chapter 5.3.

117 Only regulated when transported by sea.

299 Consignments of: cotton, dry having a density not less than 360 kg/m³ according to ISO 8115:1986, are not subject to the provisions of this Code when transported in closed cargo transport units.

Controlling

Cotton can be sold direct from producer to consumer or it can pass through several hands on its way from the producer to the consumer. Each party in the chain wants to be sure that somebody looks after their interests in the event of claims for weight, quality or damage. This is the role of the independent controller.

The services covered by the cotton controller generally cover either the supervision of, or the actual, weighing, taring, sampling of the bales, either before shipment in the producing country or export port, or after arrival at destination. Other services include, but are not confined to:

- ❑ Tallying of bales prior to loading on conveyances or during unloading of bales from conveyances;
- ❑ Inspecting bales prior to loading on conveyances or during unloading of bales from conveyances;
- ❑ External and internal inspection of bales for damage;
- ❑ Stock checks in warehouses.

The cotton controller is appointed by either party to a contract. Although controllers may be appointed (and paid) by just one party to the contract, their services should be carried out in accordance with the terms of the contract and the rules under which the cotton has been traded. This helps to maintain smooth relations between the parties to a contract and with the nominated controller.

The different parties involved can appoint their own controllers for their own account or accept the reports of the controller appointed and paid for by the first party in the chain.

Cotton can be sold on either 'shipped' or 'landed' terms. Depending on the contract terms, one party to the contract will arrange and pay for any weighing or sampling charges, while the other party may appoint a controller for its own account to supervise all such weighing and sampling activities.

Cotton can be sold under a number of terms regarding the weight, such as original gin weight, inbound warehouse weight, outbound warehouse weight and net landed weight. Net landed weight is customarily used for exports. In

this case independent controllers must be appointed by the shipper to supervise weighing and sampling of the cotton upon arrival. The weighing is performed by the Buyer or their representative at the agreed point of delivery and the controller supervises the procedure on behalf of the shipper.

Depending on the contract terms, sampling can be done before or after shipment. Pre-shipment sampling can be done at the ginneries, warehouses or at the port of shipment. The buyer usually appoints an independent controller to draw an agreed percentage of samples (of 150–200 grams each) from each lot.

Post-landed sampling is normally ordered by the seller in the event of quality disputes. In the case of arbitration, the initiating party is usually responsible for drawing and forwarding the samples to the place of arbitration. The opposing party would generally appoint its own controller to supervise and seal those samples.



Preparation of bales for sampling



Pre-shipment sampling



Arbitration sampling

Samples drawn by the controller are used for quality classing at the request of buyers for the purpose of confirming quality prior to purchase or shipment. Classing by independent controllers in the producing countries or at the port of shipment may be undertaken against the national standards of the producing countries, against Universal Standards or against private type samples. Classing can be performed manually, with mechanical testing or HVI equipment, and usually evaluates grade, colour and leaf, staple length and micronaire, and strength (or all HVI parameters).



HVI testing

When cotton is sold on landed weights and quality final 'at destination', the buyer normally arranges for the bales to be weighed after arrival either by its own staff or by another company acting on its behalf. The sellers appoint their own controllers to supervise weighing to ensure that it is carried out within the terms of the contract.

Arbitration sampling (for grade, staple, micronaire and strength), is carried out after bales have been weighed, but only if the parties to the contract are unable to resolve any disputes amicably or if requested by either one or both parties to the contract.

When cotton is sold on shipped weights and quality final, the seller normally arranges for the bales to be:

- ❑ Weighed before shipment by its own staff or by another company acting on its behalf. The Buyer may appoint its own controller to supervise the weighing to ensure that it is carried out within the terms of the contract, or alternatively will agree that the Seller appoint a mutually agreed controller for this purpose.
- ❑ The Buyer may appoint its own controller to supervise the weighing to ensure that it is carried out within the terms of the contract, or alternatively will agree that the Seller appoint a mutually agreed controller for this purpose.

The following additional services are also frequently carried out by controllers for either buyers or sellers.



Supervision of loading

Pre-shipment

Supervision of loading

- Noting the visible condition of containers before loading.
- Where possible noting the visible external condition of bales during loading to containers and/or vessels.
- Noting the marks on the bales at the time of loading to containers and/or vessels.
- Supervising the sealing of containers after loading.

Post-landed

- Supervision of unsealing, de-vanning and tallying of bales from containers.
- Surveys for external and internal damage to bales.



Supervision of de-vanning



Surveying damaged cotton

Warehouse inspections

Controllers can also be appointed by buyers, sellers, underwriters or banks to:

- Inspect the condition of warehouses.
- Carry out inventory stock checks.

These can be carried out at various locations including, but not limited to:

- Gin or other warehouses in country of origin.
- Port warehouses at ports of export.
- Consignment warehouses after export.

Who appoints the controller?

Pre-shipment

- Buyers can appoint their own controllers to supervise the above-mentioned pre-shipment services on their behalf.

- ❑ Sellers also can appoint their own controllers to supervise the above noted pre-shipment services on their behalf.

Post-landed

The shipper normally appoints a controller to supervise buyers (or their representatives) weighing, sampling and/or any other surveys called for by the buyer.



Container loading



Unloading bales from truck

ICA Rules and Bylaws⁸

The majority of contracts for international trade are agreed subject to ICA Rules and Bylaws. In the event of a dispute concerning quality or performance, they are subject to ICA dispute resolution procedures. The Rules under which cotton is sold should appear in the contract of sale. However, it should be noted that the terms of a contract take priority over the Rules, unless otherwise stated.

For further clarification, the ICA Rules and Bylaws covering the controller's services are quoted in italics in this section.



Supervision of bale-by-bale weighing

Pre-shipment weighing

Rule 216

1. Gross Shipping Weights – must be established by an independent weighing organisation or other organisation as determined in writing between the buyer and seller within 42 days (6 weeks), or any other time period as agreed between buyer and seller, before shipment.

Weighing

Weighing can be carried out bale by bale, or by weighbridge. Generally sellers weigh the cotton themselves or appoint a representative to act on their behalf under the supervision of a controller appointed by buyers, or buyers appoint a controller

⁸ The Rules and Bylaws quoted in this section are those believed to be in force on the date this document was prepared. However, the Rules and Bylaws are subject to change as may be approved by the ICA membership from time to time.

to act on their behalf for the account of the seller. There may be other variations on the same theme, and it is essential that actual weighing terms are clearly stated in contracts.

Sellers should always make bales available to buyers' controllers in order that they may carry out their principals' instructions.

Other pre-shipment services



Checking the seal on a container

A controller generally offers the following pre-shipment services:

- Count bales as they are unloaded from conveyances at port or inland terminals.
- Visually inspect the insides of containers for suitability to load.
- Count bales as they are loaded on conveyances.
- Check the visible exterior of bales as they are loaded to conveyances. Note that bales are frequently loaded four or more at a time, and only limited parts of bales can be observed at this time.
- Witness the sealing of containers after loading.

Post-landed weighing

Rule 215

All cotton must be weighed 'gross weight' on a bale by bale basis unless otherwise agreed. The tare is to be deducted from the gross weight.

Rule 216

2. Gross Landing Weights – All cotton must be weighed by the buyer under the supervision of the seller's representatives at the agreed point of delivery or other location as determined by the buyer and seller. If the cotton has already been sampled, a weight allowance must be made for the samples taken.

- *If by weighbridge; must be established at the point of delivery or other location as determined in writing between the buyer and seller, in any event within 14 days (2 weeks) of the date arrival of the cotton.*
- *If bale by bale; must be established at the point of delivery or other location as determined in writing between the buyer and seller, in any event within 42 days (6 weeks) of the date of arrival of the cotton.*

3. Both the buyer and the seller can appoint representatives at their own cost to supervise any weighing. The party arranging the weighing must advise the other party where and when it will take place, allowing a reasonable time to enable the representative to attend.

(Please read Rule 215).

Bale by bale weighing

Each bale should be weighed individually and the tag numbers, marks and gross weight of each bale should be recorded. The weight of bales which arrive with no mark, incorrect marks or appear wet and/or damaged should be calculated in accordance with Rule 217 (paragraphs 1–3) as detailed below.

Rule 217

1. The weight of bales which are condemned, short-landed, burst, wrongly marked or not marked will be calculated according to the average gross weight of the landed bales, as long as at least 25% of the lot has been landed in good condition. If less than 25% is in good condition, the weight of these bales will be calculated according to the average invoice weight.



Bale-by-bale weighing

2. If the buyer accepts bales which are wrongly marked or not marked, those bales will be weighed, and the weights shown separately.

3. If the buyer does not weigh the total shipment within 42 days (6 weeks) of the date of the arrival of the cotton, the unweighed bales will be calculated according to the average gross weight of the weighed bales, as long as at least 90% of the lot has been weighed. If less than 90% of the lot has been weighed, the weight of the unweighed bales will be calculated according to the average invoice weight.

Weighbridge weighing

Conveyances should be weighed while they are fully loaded and again after they have been unloaded while they are stationary on the weighbridge.



Weighing truck at warehouse

Bales should be counted while they are being unloaded from the conveyances and any missing or short-landed bales should be calculated in accordance with Rule 217 (paragraphs 1–5) as detailed above and below.

Rule 217

4. If the shipment is by container and all the containers are loaded onto one ship, the 25% referred to in paragraph 1 of this rule will apply to the total number of bales delivered.

5. If the shipment is by container and the containers are loaded onto more than one ship, the 25% referred to in paragraph 1 of this rule will apply to the number of bales delivered in each ship.

Container seal numbers should be checked and recorded before doors are opened and note should be taken of any containers with broken or missing seals in accordance with Rule 9 of Section B of the Container Trade Rules Agreement between ICA and the American Cotton Shippers Association which states:

Missing bales: In case of shipper's load and count, seller is liable for the contents of the container. Unless otherwise agreed between buyer and seller, any claim must be supported by certificates issued by seller's controller stating the container serial and seal number and certifying that the seal was intact. However, in shipments involving 'pier to house' or 'house to house' movements and when seals are broken by customs or other authorities at port of entry container must be re-sealed and both the original seal and new seal numbers provided to shipper's controller.

Taring**Rule 213**

1. Unless the seller declares and guarantees otherwise, all cotton must be sold on actual tare.

2. The buyer can insist that the actual tare be established at the time of delivery. The actual tare must be measured within 42 days (6 weeks) of the date of arrival of the cotton and must be carried out by the buyer under the supervision of the seller's representatives. This will then be the measurement of tare applied to the weight adjustment.

3. If the buyer insists that the tare be measured and it proves to be not more than the allowance given in the contract or invoice, the buyer will have to pay the costs of taring. Otherwise, the seller must pay these costs.

Rule 214

1. To calculate actual tare, a minimum of 5% of the bales, subject to a maximum of 10 bales of each type of tare composed in any one lot or mark must be checked.

2. Actual tare is established by ascertaining the average weight of the wrapping, bands, ropes or wires from each type of the different tares comprising the lot or mark and multiplying the average weight of each type of tare by the total number of bales in the shipment.

3. Repaired bales must be tared separately.



Taring

All loose cotton, dirt and dust should be removed from the bale covers before they are weighed.

Arbitration sampling, micronaire sampling and sampling for strength

Part 3: Sampling (other than for moisture)

Rule 209

1. Sampling must take place at the point of delivery or other location as determined between buyer and seller. The buyer's and seller's representatives must supervise the sampling. The seller must give the name of his representative to the buyer:

- Before sending the buyer an invoice; or
- With the invoice.

2. Samples for arbitration must be drawn, sealed and marked in the presence of both the buyer and seller and/or their respective representatives.'

(Please read Bylaw 325)

Rule 210

1. A sample from a bale of cotton should weigh about 100 grams.

2. American and Australian cotton must be sampled 100%. Unless otherwise agreed, other cottons need only be sampled on the basis of 10% representative samples from each lot or mark as defined on the seller's commercial invoice.

3. *Samples may be drawn from part lots and/or shipments; however, a claim may only be made on the number of bales available at the time of sampling.*
4. *If the buyer or seller believes that the cotton or cotton waste is false packed, mixed packed or in plated bales, every bale must be sampled, and samples must be drawn from each side of the bale.*
5. *In the event that a quality arbitration award is made, the party, whose final written offer for amicable settlement is furthest from the quality arbitration award, must pay for the cost of drawing of samples and dispatch of samples.*

However, if the quality arbitration award is less than the seller's final offer for amicable settlement, then the buyer must pay for the cost of drawing and dispatch of samples.

If there is no written offer for amicable settlement by both of the parties, the cost of drawing and dispatching of samples shall be shared in equal proportions.

Rule 211

The buyer must not sample the bales before weighing without the seller's permission.

Rule 212

If the seller takes a set of samples, he must pay for them at the contract price of the cotton.

Arbitration sampling

Bylaw 325

1. *In quality arbitrations, unless both firms agree otherwise:*
 - *Samples to be used must be taken within 42 days of the date of arrival of the cotton;*
 - *Arbitration must be commenced in line with Bylaw 319 within 49 days of the date of arrival of the cotton; and*
 - *Samples must be sent to the place of arbitration within 70 days of the date of arrival of the cotton.*
2. *A committee appointed by the Directors (Standing Committee A) can extend these limits, but only if the firm concerned can show that substantial injustice would otherwise be done and that the request for an extension is reasonable in all the circumstances. Applications must be made to us in writing. The committee will take the other firm's comments into account before it makes a decision.*

Micronaire sampling

Bylaw 340

1. *This bylaw applies to all disputes about micronaire, including disputes concerning American cotton. Its terms are intended to be consistent with a micronaire agreement between us and the American Cotton Shippers Association, but if there is any conflict between the two, the terms of this bylaw will take priority after the terms of the contract.*
2. *If there is a dispute about the micronaire, the cotton will be tested again and the following will be done:*
 - a. *The buyer will choose which bales are to be tested. The time limits for commencing arbitration and sending samples for testing are the same as those laid down for quality arbitration.*

(Please read Bylaw 325)

- b. *If samples have already been taken for arbitration in line with Rule 209, the same samples can be used for the micronaire tests.*
- c. *For American cotton:*

If new samples have to be taken, they should be taken in line with ASTM sampling procedures Designation D1441-54, except that both samples may be taken from one side of each bale. If one firm asks that an average micronaire reading be obtained from these two samples, that firm asking must pay the additional cost.

For non-American cotton:

If new samples have to be taken, they should be taken in line with Rule 209.

- d. A first set of tests will be done in a laboratory agreed between the buyer and seller or their arbitrators. If there is no agreement or no other laboratory available, the tests will be done in our laboratory.*
 - e. The laboratory which does the tests will issue a certificate signed by one of its officers. The certificate will show the results of the test, and the fees, costs and expenses.*
 - f. Either firm can appeal against the first test results within 21 days of the results being dispatched. The appeal must apply to the total number of bales in the first test. If no appeal is lodged against the test results, the information on the certificate will be final and both firms will be bound by it, and the arbitrator, arbitrators or umpire will then make an Award.*
 - g. A second set of tests, done as a result of the appeal against the test results, can be done in any laboratory agreed between the buyer and seller or their arbitrators. If there is no agreement or no other laboratory available, the tests will be done in our laboratory. The tests will be made on pieces of cotton drawn from the original samples.*
 - h. If another laboratory is to do a second set of tests, the first test results must not be given to that laboratory.*
 - I. Unless both firms agree otherwise, our laboratory can do the second set of tests, even if it also did the first set.*
 - j. The laboratory which does the second tests will issue a certificate signed by one of its officers. The certificate will show the results of the test, and the fees, costs and expenses. The information on the certificate will be final and both firms will be bound by it. The arbitrator, arbitrators or umpire will then make an Award.*
 - k. Either firm can appeal against the Award given by the arbitrator, arbitrators or umpire in line with Bylaw 349, but no further tests will be conducted unless both firms agree otherwise.*
- 3. Unless the firms agree otherwise, the usual control limit of 0.3 will apply.*
 - 4. If the contract states 'micronaire' but does not say whether it should be the 'minimum' or 'maximum', it will be taken to mean 'minimum micronaire'. However, both firms can agree otherwise in writing before they send the samples for testing.*
 - 5. A contract may say how much variation is acceptable in the other fibre characteristics that can be determined by recognized laboratory tests.*
 - 6. Whoever asks for the tests must pay the laboratory the whole cost. But if the buyer pays, the seller must repay the cost of testing every bale which does not come within the control limit set out in the contract.*
 - 7. The costs of micronaire tests done in our laboratory are laid down in Appendix D of our rule book.*

Sampling for strength

Bylaw 341

- 1. In any dispute about strength, the procedure in Bylaw 342 will apply. However, the terms of the contract will take priority over Bylaw 342 if the two conflict.*

2. Unless the buyer and seller agree otherwise, for contracts which set out a minimum strength value, the allowances for bales which do not reach this minimum will be as follows:

HVI – grams/tex below the control limit by:	between	and	Percentage allowance
	1.1	2.0	1.0
	2.1	3.0	1.5
	3.1	4.0	3.0
	4.1	5.0	5.0
	5.1	6.0	8.0

Plus 4% for each gram/tex below 6.

Pressley – psi below the control limit by:	between	and	Percentage allowance
	1050	3000	1.5
	3050	5000	3.0
	5050	7000	5.0
	7050	9000	8.0

Plus 4% for each 2000 psi below 9000.

Bylaw 342

1. If there is a dispute about the strength, the cotton will be tested again and the following will be done:

a. Only samples from the bales in dispute will be tested. The time limits for commencing arbitration and sending samples for testing are the same as those laid down for quality arbitration.

(Please read Bylaw 325)

b. If samples have already been taken for arbitration in line with Rule 209, the same samples can be used for the strength tests.

c. If new samples have to be taken, they should be taken in line with Rule 209.

d. A first set of tests will be done in a laboratory agreed between the buyer and seller or their arbitrators. If there is no agreement, the tests will be done in our laboratory.

e. Either firm can object to the first test results within 21 days of the results being dispatched. The objection must apply to the total number of bales in the first test. If no objection is made against the test results, the information on the laboratory certificate will be final and both firms will be bound by it, and the arbitrator, arbitrators or umpire will then make an Award.

f. If an objection is made, a second set of tests must be done in a laboratory agreed between the buyer and seller. If one firm demands it, the second tests must be done in a different laboratory and if the firms cannot agree which laboratory should be used, we will decide. We will not do both sets of tests in our laboratory unless both firms agree. The tests will be made on pieces of cotton drawn from the original samples. The information on that laboratory certificate will then be final and both firms will be bound by it, and the arbitrator, arbitrators or umpire will then make an Award.

g. If another laboratory is to do a second set of tests, the first test results must not be given to that laboratory.

h. Either firm can appeal against the Award given by the arbitrator, arbitrators or umpire in line with Bylaw 349, but no further tests will be conducted unless both firms agree otherwise.

i. Any laboratory which does tests will issue a certificate signed by one of its officers. The certificate will show the results of the test, and the fees, costs and expenses.

2. Unless the firms agree otherwise, the usual control limit of 2.0 grams/tex or 3000 psi will apply.
3. Whoever asks for the tests must pay the laboratory the whole cost. But if the buyer pays, and if an allowance is paid to the buyer, the seller must repay the buyer the cost of testing samples from bales on which an allowance is due.
4. The costs of strength tests done in our laboratory are laid down in Appendix D of our Rule book.

Moisture sampling

Rule 233

If the buyer and seller disagree about a claim for internal moisture, the dispute will be settled by arbitration under our bylaws.

Rule 234

The following will apply when sampling bales to test for internal moisture:

- *Samples of at least 250 grams must be taken from each bale to be sampled. These samples must be taken by the representative of the party who has asked for the test, and in the presence of a representative of the other party (if it appoints one). The samples must be taken at the time of weighing.*
- *Representative samples must be taken from 5% of the bales in each lot (at least 3 bales). These bales must be selected at random. Samples must be taken from at least two different parts of each bale from a depth of about 40 centimetres inside the bale. The samples must be placed at once in dry, hermetically-sealed containers and labelled to show the identity of the bale the samples have come from.*
- *The samples must be sent immediately to a testing laboratory mutually acceptable to both parties.*

Rule 235

1. The buyer must:

- *give notice of any claim for internal moisture within 42 days (6 weeks); and*
- *produce a report from a mutually agreed laboratory and final claim within 63 days (9 weeks),*

of the date of arrival of the cotton.

2. The allowance given to the buyer will be based on the laboratory's report. The allowance will be the difference between:

- *the weight of the absolutely dry fibre in the lot plus the percentage of moisture regain set out in the contract; and*
- *the total weight of the lot.*

This allowance will also be based on the invoice price.

Rule 236

The party claiming and asking for the moisture test will have to pay the cost of sampling and all related charges. If the claim is proved, sampling, courier and laboratory charges will be reimbursed by the other party.

General

Tag numbers and marks should always be checked to ensure that the correct bales are sampled. Before sampling, bale covers and the surface cotton in the areas to be sampled should be removed and samples drawn from within the contents of the bales.

Surveying

Damage and/or foreign matter contamination surveys are generally conducted after landing. Controllers normally attend surveys on shippers' behalf, that have been arranged by buyers on allegedly damaged bales (whether exterior or interior damage) or bales with foreign matter contamination. Surveys are covered by the following Rules 205A, 206, 207, 230 and 231. Tag numbers and bale marks should always be recorded.

Rule 205A

Unless otherwise agreed between the parties, the seller shall be responsible for country damage, subject to the limitations detailed in Rule 207 b.

Rule 206

The following conditions apply to contracts where the seller is responsible for providing marine cargo insurance, transit insurance and country damage insurance:

- a. There must be a policy document or certificate of insurance. This document or certificate must be produced as one of the shipping documents.*
- b. If the cotton is country-damaged when it arrives, the buyer must separate the damaged bales and must make a claim against the seller within 7 days (1 week) of weighing or devanning, whichever is later, notwithstanding that the claim must be made within 42 days (6 weeks) of arrival of the cotton. The parties must try to agree on an allowance. If they cannot do so, a Lloyd's Agent, or a qualified surveyor recognized by the insurance company shall be appointed to inspect the damaged cotton. The cost of the survey shall be for buyer's account in the first instance. If the survey confirms country damage, the seller's insurance shall be called upon to pay:
 - the buyer for the market value of any country damaged cotton removed from the bales as set out in the surveyor's report, plus any reasonable charges incurred in the separation of the country damaged cotton,*
 - the cost of the survey.**
- c. If a charge is made for collecting the insurance claim and the buyer pays it, the seller must refund the buyer. If the loss is not covered by seller's insurance the seller must pay.*

Rule 207

The following conditions apply to contracts where the buyer is responsible for providing marine cargo insurance or transit insurance, and the seller responsible for providing country damage insurance:

- a. So that the buyer can arrange insurance, the seller must give the buyer the necessary details of each shipment.*
- b. If the cotton is country-damaged, the buyer must separate the damaged bales and must make a claim against the seller within 7 days (1 week) of weighing or devanning, whichever is later notwithstanding that the claim must be made within 42 days (6 weeks) of arrival of the cotton. The parties must try to agree on an allowance. If they cannot do so, a Lloyd's Agent, or a qualified surveyor recognized by the insurance company shall be appointed to inspect the damaged cotton. The cost of the survey shall be for buyer's account in the first instance. If the survey confirms country damage and that the damage is greater than 1.0% of the total weight of the shipment, subject to a minimum claim of \$500.00, the seller's insurance shall be called upon to pay:
 - the buyer for the market value of any country damaged cotton removed from the bales as set out in the surveyor's report, plus any reasonable charges incurred in the separation of the country damaged cotton,*
 - the cost of the survey.**

c. If a charge is made for collecting the insurance claim and the buyer pays it, the seller must refund the buyer. If the loss is not covered by the seller's insurance the seller must pay.

Part 10: Claims for false packed, mixed bales and so on

Rule 230

1. The buyer must claim for false packed, mixed packed or plated bales within 6 months (26 weeks) of the date of arrival of the cotton. If the seller tells the buyer within 14 days (2 weeks) of the claim being proved that he intends to take back this cotton, he has the right to do so. If the buyer has already paid for the cotton, the seller must buy it back at the market value of good cotton on the date the claim is proved and repay the buyer his expenses.

2. If the seller does not take back the cotton, the claim must be settled based on the market value of good cotton on the date the claim is proved to the seller. The seller must also repay the buyer his expenses.

3. The buyer must claim for unmerchantable cotton within 6 months (26 weeks) of the date of arrival of the cotton. The bales must be set aside for inspection for a further 56 days (8 weeks) and the inspection must be done by an agreed expert. The buyer will be able to claim reasonable expenses from the seller for putting the bales into a merchantable condition. The buyer can also claim the value of any damaged cotton removed from the bales. The value must be based on the market value of the good cotton on the date the claim is proved to the seller. Any bales damaged as the result of fire can be invoiced back to the seller. This paragraph does not apply to country damage or damage caused by salt water or any accident during shipping.

4. The buyer must claim for foreign matter in the cotton within 6 months (26 weeks) of the date of arrival of the cotton. The bales must be set aside for inspection for 56 days (8 weeks) after the claim is made and the inspection must be done by an agreed expert. The buyer will be able to claim reasonable expenses from the seller for removal of the foreign matter.

Rule 231

The buyer must give notice of any claim for country damage as detailed in Rules 206 or 207 and the survey shall be completed within 14 days (2 weeks) of the notice of claim, or within 56 days (8 weeks), of the date of arrival of the cotton, whichever is earlier.

The role of banks in cotton export finance

Cotton as a globally traded commodity is subject to the particular financing requirements and the risk profile of cross-border transactions. Cotton exporters have to find answers to key financial questions, especially how:

- ❑ To secure funds to bridge the liquidity gap between payment for the raw cotton purchase, transport, storage, processing, etc. until payment is made by the buyer under the export contract;
- ❑ To secure payment by the buyer.

To raise financing and structure the export process, exporters turn to domestic banks, international banks, buyers, input (seeds and fertilizers) suppliers and export support organizations. The main sources of finance and risk cover are banks; in the section that follows, the focus will thus be on the role that banks play in raising funds and mitigating risks related to cotton exports.

The exact credit structure will depend on an individual borrower's solvency, balance sheet, internal risk control systems, general standing and track record,

on the security available under the transaction and its related legal aspects. As such, smaller companies are, as a rule, likely to be subject to more stringent controls than substantial and well-known companies. The costs of bank credit facilities and other related services differ from country to country and depend mainly on the solvency of the borrower as well as the strength of the underlying transaction.

Transactional finance

Principal credit standards

The most common type of financing is based on the strength of the export transaction. This type of financing is referred to as transactional finance. As a rule, the credit line agreed between the bank and the cotton exporter, and each utilization by the latter, are directly linked to the underlying commercial transaction. The financing covers the period from the purchase of the cotton or its production process through to the final payment of the sales proceeds by the buyer of the cotton.

Typical structures of transactional finance for cotton producers and traders involved in exports are borrowing base facilities, inventory finance, pre-sold, and back-to-back transactions where the quantity and quality of the cotton purchased and resold are the same.

Major criteria used by banks assessing the strength of an export transaction are:

- The buyer's solvency and reliability;
- The status and terms of the export sales contract;
- The quality, storage, transportation and processing of the cotton;
- Price and currency risks;
- The exporter's ability to deliver the cotton as agreed.

As a rule, for all financing, export goods must comply with industry, government and contract specifications. Payment by the buyer must be in line with foreign exchange and other governmental regulations.

Transactional financing is subject to proper loan documentation providing, among other things, for: the assignment of accounts, receivables, insurance policies and proceeds under the export contracts; the pledging of goods; and possibly also non-transaction-related collateral such as mortgages.

Borrowing base and inventory financing are related to physical stocks: these stocks are generally stored in eligible warehouses, properly marked, stored separately and clearly identifiable. Goods in storage should preferably be represented by title documents (e.g. warrants). Suitable commercial all-risks insurance covering storage, transportation and loading onboard ship should be in place.

Mitigation of the buyer's payment risk

A major risk facing the cotton exporter and the financing bank in transactional finance is that of non-payment by the buyer for the cotton that has been delivered. It is therefore of vital importance to carefully assess the buyer's ability and willingness to make payment. In cases where financing is provided by the bank, the receivables are assigned to the bank and the buyer makes payment into the borrower's account with the financing bank.

Below are some of the tools that can be used to eliminate or at least mitigate the risk of non-payment by the buyer:

Letters of credit (L/Cs)

An L/C is a payment instrument in which a bank assumes the payment obligation of the buyer. An L/C is:

- The written assurance of bank
- On the instructions of the applicant (buyer)
- To pay a specific amount
- To the beneficiary (exporter)
- In the agreed currency
- Against submission of documents in conformity with the documentary credit
- Within the prescribed deadlines.

The information on payment flow is shown in figure 3.1 below.

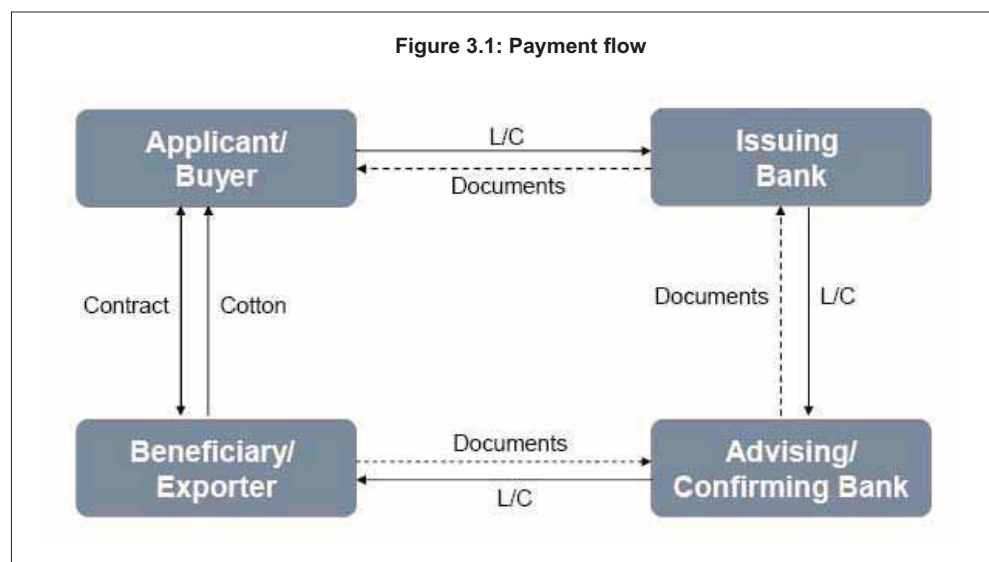

One of the major advantages of an L/C is that the bank will effect the payment regardless of the buyer's willingness to pay (meaning that the buyer cannot withhold payment on any pretext), provided the documents submitted are in conformity with the documentary credit. It is therefore very important for the exporter to ensure that no discrepancies arise in the documents: if there are discrepancies, the bank is no longer obliged to pay.

Another major advantage is that L/Cs are subject to the Uniform Customs and Practice for Documentary Credits (UCP), which are recognized and accepted worldwide.

By choosing an L/C, the cotton exporter transfers its payment risk from the buyer to the bank. This risk can also be mitigated by asking another bank (one with a better rating, for example) to confirm the relevant L/C. In this case, the confirming bank promises to pay as stipulated in the letter of credit against presentation of documents that conform with the L/C. Confirmation by a bank located in a country other than the one where the issuing bank is located removes the transfer, political and credit risks in respect of the issuing bank.

Standby letters of credit

A special form of documentary credit is the standby letter of credit. The standby L/C basically fulfils the same purpose as a guarantee: it is payable upon first demand and without objections or defences on the basis of the underlying

transaction. The standby L[©] is used to secure any claims the beneficiary might have against the applicant due to a breach of contract. It may cover performance obligations by the exporter or payment obligations by the buyer. The documents presented in the claim under the standby L[©] must be submitted within the period specified therein and in the required format. These documents should show that the party that applied for the standby L[©] has not or has insufficiently fulfilled its obligations.

Documentary collections

Documentary collection offers the exporter far greater security than selling on open account, but not as much as an L/C. Credit, political and transfer risks, for instance, are not covered. Documentary collections can be either

- Documents against payment (DP) – instructions under a collection order to hand over the documents to the buyer against payment; or
- Documents against acceptance (D/A) – instructions under a collection order to hand over the documents to the buyer against acceptance of the bill of exchange drawn on it.

The advantage of documentary collections is that the documents, and thus the cotton, can be released to the importer simultaneously upon payment of the amount owed or acceptance of a draft. Furthermore, documentary collections are subject to the Uniform Rules for Collections (URC). However, if the importer refuses to accept the documents, losses can be incurred by the exporter. The exporter may be obliged to find an alternative buyer, which may prove to be extremely costly or even impossible.

Advance payments or export pre-finance

If the buyer and the exporter have a good track record and a trusting relationship, they might agree that part of the payment for the future exports should be made in advance. To provide clear conditions for the advance payment and its reimbursement if the exporter fails to meet its contractual delivery obligations, banks are involved to provide assurances through guarantees and letters of credit.

Banks can also be involved in financing advance payments on behalf of the buyer or even for their own account. In these cases, the bank grants a loan to a cotton exporter in an emerging market country, either directly or indirectly via the buyer. The facility is repaid using the proceeds from the sale of the cotton. As a rule, the receivables under the sales contract are assigned to the bank and paid directly by the buyer to the borrower's account with the bank. The bank could also ask for the underlying cotton to be pledged in its favour.

Advance payment guarantee

The buyer of the cotton demands an advance payment guarantee to ensure that any advance payment on the contract made before delivery of the goods will be reimbursed if the exporter fails to meet some or all of its delivery obligations. The advance payment guarantee is issued by the bank at the request of the exporter and may be counter-guaranteed by the buyer's bank. An advance payment guarantee may also be issued in the form of a standby L/C.

Red clause letter of credit

Under this type of L/C, the issuing bank agrees to advance part of the estimated sale proceeds of the cotton to be shipped, without remittance of the shipping documents. The balance is then paid once the shipping documents are presented. Obviously, the issuing bank and the buyer will issue strict directions as to how, when, by whom and under what circumstances funds may be drawn.

Conditions for the draw-down may include warehouse receipts as collateral (also referred to as green clause), advance payment guarantees and conclusion of an advance payment agreement. Depending on their assessment of the exporter's reliability, the buyer's bank or the buyer may decide to appoint someone to supervise the stocks on their behalf – such supervision is usually called collateral management.

Warehouse receipt systems

Marketing systems for agricultural commodities, including cotton, have changed considerably since the 1980s and have affected the livelihoods of over two billion farmers in commodity-dependent developing countries. International stocks and price management mechanisms have been dismantled, leading to steady decline and increased short-term variability in commodity prices. Domestic cotton marketing systems have also been reformed in most developing countries, with the State's involvement in input and output marketing, as well as in setting domestic producer prices, being substantially scaled back or abolished. The parastatal cotton marketing boards are no longer directly involved in cotton exports, their role being primarily limited to sector policy-making. Second-tier cooperatives, the cooperative unions, which used to dominate domestic procurement of cotton, have become rather marginal players. These reforms have allowed increased private sector participation in cotton marketing, but the impact has been rather mixed due because of the following constraints:

- ❑ Lack of trade finance, limiting price competition (especially at the farm gate) and also leading to concentration of market power in a few foreign companies, which have access to relatively cheaper offshore finance.
- ❑ Decline in cotton quality, accompanied by loss of quality premium enjoyed by exporting country. This is often due to weak enforcement of quality standards in private trade and non-payment of quality premiums at the farm gate, although further down the marketing chain some traders enjoy premiums for quality.
- ❑ Lack of certainty regarding the other party's performance, especially where traders from producer countries lack the required track record.
- ❑ Price uncertainty, originating in part from global price volatility but accentuated by significant intra-seasonal price swings as producers are often compelled to sell because of household cash needs rather than by expected price movements.

This section discusses how the use of warehouse receipts systems (WRSs) can help address some of these constraints and thereby improve benefits to producers from the reforms. Cases from Uganda and the United Republic of Tanzania illustrate how WRSs can simultaneously help address some of these problems, notably by easing access to finance, reducing transaction costs (through the use of standardized grades and trading by description), and shortening the commodity chain linking farmers to end-users.

What are warehouse receipt systems?

Under a WRS, a warehouse receipt (WR) is issued to a named depositor (who may be a farmer, farmer group, processor or trader) as evidence that he or she has deposited a specified commodity, of stated quantity and quality, at a specified location. The holder of the receipt may pledge it to a lender (with the stored commodity being the collateral for a loan) or transfer it to a buyer (by way of a sale). The warehouse operator or collateral manager, who has custody of the stocks, guarantees delivery against the receipt, and should be able to

make good any value lost through theft, fire or other catastrophes. The key players in the WRS are depositors, the warehouse operator or collateral manager, and lenders. Their roles, responsibilities and benefits may differ depending on whether the WRS is regulated or not as discussed below.

Unregulated warehouse receipt systems

An unregulated WRS is a legal or formal system of inventory collateralization, in that the provision of services as well as the rights and obligations of parties are based on existing contract law. Aggrieved parties can therefore seek redress through the courts. However, unlike the regulated WRS, neither the collateral managers (who take custody of stored commodities) nor the issuing of receipts are regulated by an independent regulatory agency.

Contractual obligations and rights under the system are usually defined in tripartite *collateral management agreements* between three key players shown in figure 3.2: borrower, collateral manager and the lender (usually a bank). In the cotton sector, borrowers tend to be medium-scale to large-scale ginning or export companies, handling large enough volumes of seed cotton or lint to justify the cost of this service, and who either own or can lease suitable storage space. Very large traders, especially the vertically integrated multinational companies, often do not use WRS because of relatively easier access to cheaper offshore finance. For reasons of scale, it is often difficult for smaller-scale traders and groups of smallholder farmers to use it.

Figure 3.2: Key players in the unregulated WRS

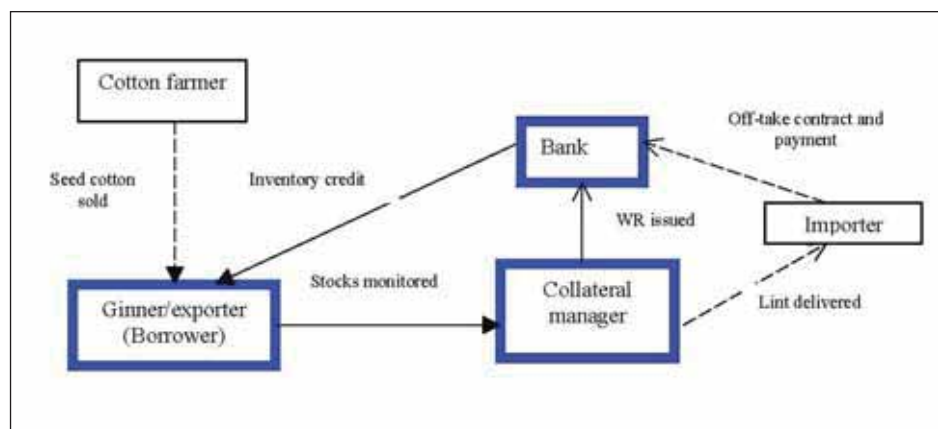

The collateral managers usually issue non-negotiable, non-transferable warehouse receipts and guarantee of delivery of the stored commodity. Most of them are local subsidiaries of international inspection companies, which obtain international insurance and performance bonds to back their guarantee of delivery. They also tend to have a track record in quality and quantity certification for various commodities. Société Générale de Surveillance (SGS) is the best-known example of such companies. Others include Audit, Control and Expertise (ACE), Cotecna, Baltic International, Bureau Veritas and Socotec/ITS.

Transaction cycle under an unregulated WRS for cotton

The cycle is typically as follows:

- The borrower applies for credit prior to the opening of the harvest season. The loan application is usually assessed on the basis of the borrower's balance sheet and track record as well as on the adequacy of security provided.

- ❑ If the loan application is approved in principle, the bank and the borrower will select a collateral manager; but quite often the bank's view is paramount in the choice made. A collateral management agreement (CMA) is then signed between the borrower (ginner), the collateral manager and the financing bank.
- ❑ The collateral manager, on the basis of the CMA, takes exclusive access to the warehouse provided by the borrower – it may be leased if the borrower does not own a suitable facility. A nominal fee (about \$1) may be paid to the borrower by the collateral manager to cement legal control over the warehouse.
- ❑ From that point, the collateral manager has legal custody of the seed cotton and/or lint stored in the warehouse and is authorized to release such stocks only with explicit authorization from the specified lender. The collateral manager is expected to provide regular updates on the quantity, quality and value of stocks, which are expected to be insured by the borrower.
- ❑ After ginning and upon receipt of a confirmed order, the bank authorizes release of the lint to an importer. The importer must have either paid for or made satisfactory arrangements to pay for the lint delivered.
- ❑ Payments to the ginner are required to be channelled through the lending bank, to ensure full recovery of the loan and related servicing costs. Some banks insist that if the contract is not backed by an L/C then stock release will be permitted only after payment has been received.
- ❑ The collateral management fee is usually between \$1,500 and \$3,000 per site per month, implying that it is more cost-effective for borrowers handling relatively large volumes of inventories.

Quite often the banks will, in addition to the CMA, require the following as additional security:

- ❑ Personal charge over the assets of directors and/or shareholders as well as a fixed and floating charge on the borrower's assets, usually the ginnery.
- ❑ A confirmed fixed-price off-take contract or L/C against which the cotton collateral will be valued.

The main drawbacks of the system include lack of access, especially by relatively small ginneries for whom the cost of collateral management and insurance may be too high. Financing decisions can be slow and the requirement for fixed-price off-take contracts often denies borrowers the opportunity to benefit from favourable price movements. Since the receipts issued are non-transferable, they can not be used as delivery instruments against contracts, hence limiting their role in facilitating trade.

Collateral managers, like other operators, sometimes experience losses through theft and fraud. Their liabilities, when they occur, are often limited by indemnity and 'limitation of liability' clauses in the CMA. Hence, it is essential for lenders to carry out effective due diligence in the selection of collateral managers and closely monitor their operations.

The regulated warehouse receipt system

The involvement of an independent regulatory agency is what distinguishes the regulated WRS from the unregulated model. The regulatory agency may be government-based, as is the case in the United States (where USDA is the main regulator) and the United Republic of Tanzania, which opted for this model following promulgation of enabling legislation in 2005. A private-sector-based agency, for instance a strong commodity exchange as is the case in South Africa, can also regulate warehouse operators issuing negotiable receipts which are

traded. In Zambia and Uganda, another model is being promoted, in which an arm's-length private-sector-controlled agency is authorized by the government to enforce appropriate laws and industry standards regulating the WRS.

The independent regulator is responsible for licensing or certifying warehouse operators as custodians of collateralized stocks (ensuring that they comply with criteria set in relevant laws and regulations); regulating the issue of standardized warehouse receipts to minimise the risk of fraud; and overseeing the operations of warehouse operators (including carrying out unannounced stock and quality verifications).

Licensed operators offer 'public' warehousing services, implying that they can store commodities on behalf of multiple depositors (of all sizes) in a single warehouse or site. The receipts issued may be transferable and negotiable, depending on the enabling legislation. Licensed warehouse operators may include international as well as local inspection companies, and processing companies such as ginneries.

Transaction cycle under the regulated WRS

Depositors requiring financing for initial procurement of seed cotton apply for credit prior to the opening of the marketing season. The application is usually appraised on the basis of traditional criteria and procedures, including:

- The borrower's balance sheet and credit history or track record.
- Satisfactory demonstration of the feasibility of the proposed activity.
- Personal charge over the assets of directors and/or shareholders, and/or fixed and floating charge on the company/group's assets.
- Price risk mitigation, in the form of off-take contracts, where market-based price risk instruments are absent.

As in the case of lending under the unregulated WRS, decision-making is slow and bureaucratic, involving recommendations by credit officers, credit committees and management.

Once seed cotton is procured or assembled by farmer groups, it is delivered to designated ginneries for storage and processing. The independent regulatory agency is responsible for licensing or certification of the designated ginneries. Deposits can be made by any party but must meet the following criteria:

- Minimum volumes as determined by individual designated ginneries (e.g. 3 to 7 tons of seed cotton in the United Republic of Tanzania and Uganda) – in order to reduce administrative, transport and transaction costs.
- Minimum quality standards set by the independent regulator in consultation with the trade. The seed cotton must be storable, and the lint readily marketable.

The designated ginners issue WRs to depositors, after weighing and grading the seed cotton deposited. The WR states the quantity and quality of the seed cotton deposited; the name of the depositor; and the obligation of the ginner to deliver the seed cotton described or its lint equivalent to the depositor or a bona fide party to whom the receipt has been transferred. The WR also contains the terms and conditions under which the stocks are being stored.

Where the depositor intends to borrow against the collateralized stocks, the process involved includes the following steps:

- The borrower approaches a bank providing inventory financing with the relevant application backed by the WR and, where required, an off-take contract.

- ❑ The bank confirms the status of the WR from the designated ginner before advancing any credit – this is critical in minimizing the risk of fraud.
- ❑ The credit advanced depends on the market valuation of the lint out-turn from the deposited seed cotton, with appropriate adjustments reflecting anticipated future price movements.

Prior to sale, a system of monitoring the collateralized stocks is enforced to safeguard the interests of depositors and lenders, including:

- ❑ Submission by warehouse operators of daily stock position reports to lenders and the regulators.
- ❑ Unannounced inspections by regulators to verify the volume and quality of stocks and confirm compliance with storage standards and regulations.
- ❑ Complementary inspections by insurance companies and banks.
- ❑ Monitoring of market developments that affect the value of the collateral by credit officers, who can advise clients liquidate stocks if necessary to minimize exposure to potential adverse price movements.

When the crop is sold, payment is required to be made through to the financing bank. This is often included in the off-take contracts.

The financing bank will, after being satisfied that the loan obligations have been satisfied, release the WR to the bona fide buyer, who can take delivery of the lint or seed cotton, after presentation of the WR to the designated ginner. When the WR and instructions from the bank are presented, the ginner will allow delivery of the lint or seed cotton to the buyer and cancel the WR to complete the transaction.

The regulated WRS has the added benefit of being accessible by small-scale operators, such as farmer groups, as illustrated in the cases from the United Republic of Tanzania and Uganda. However, establishing such a system requires painstaking work on creating and maintaining a supportive regulatory and policy environment.

WRS pilots for cotton in the United Republic of Tanzania and Uganda

The regulated WRS has been successfully piloted in the United Republic of Tanzania and in Uganda. One farmer group, the Oridoyi Rural Cooperative Society in the United Republic of Tanzania, which has used the system, was able to raise seed cotton output by its members almost 10-fold over a period of four years. Financing was provided by a local bank, CRDB Bank Ltd, which also lends about \$10 million per year against collateralized coffee. The cooperative was also able to market its lint direct to a United Kingdom-based cotton merchant in the 2005/06 season. The rise in output was primarily financed by the cooperative society from retained profits accumulated through marketing cotton on behalf of its members, through the WRS.

In Uganda, the Nyakatonzi Cooperative Union offered storage and toll-ginning services to its member primary cooperative societies, making it possible for them to use the WRS. The primary societies did not obtain inventory finance, as members were prepared to wait for payment until after the lint was sold. Participating farmers earned incremental income of over 40% because they sold lint and cottonseed, instead of seed cotton. The cooperative union also benefited from increased throughput without having to raise additional financing for procuring seed cotton.

Source: Natural Resources Institute reports.

Insurance in an uncertain world

This section discusses a range of insurance issues with reference to the dynamic and challenging nature of the cotton industry. Growers, ginners, financiers, merchants or spinners, should all find that the topics covered assist in developing a greater understanding of how insurance works.

There are three key principles involved in understanding the fundamentals of insurance: risk, indemnity and utmost good faith.

Risk

A risk, according to the Chambers Dictionary, is a ‘*hazard, danger, chance of loss or injury, degree of probability of loss, person, factor or thing likely to cause danger, to incur the chance of unfortunate consequences by doing something.*’

A combination of factors are associated with the term ‘risk’, including uncertainty, cause of loss and level of loss. The level of loss is a combination of frequency (how often the event may happen) and the severity (the financial impact of the event).

Management of risk

In all businesses it is important to manage the impact of risk according to the severity faced. This is in terms of both business profitability and reputational risk (with clients and financiers). An audit of the risks your organization faces enables you to understand which of these risks can and should be ‘transferred’, and to assess the resulting cost. This transfer of risk can be made through a number of methods including better cost control or collateral management, or more traditionally, through the purchase of insurance.

Figure 3.3 below illustrates the process for effective risk management. Initially risks should be identified and analysed according to how severe they could be and at what frequency they might occur. Following this, a business must decide how to mitigate these risks, by either retaining and managing or transferring the risk. Whichever option is chosen, it is important to monitor and review the exposure to ensure the organization is not exposed to unnecessary risk.

Figure 3.3: The process for effective risk management

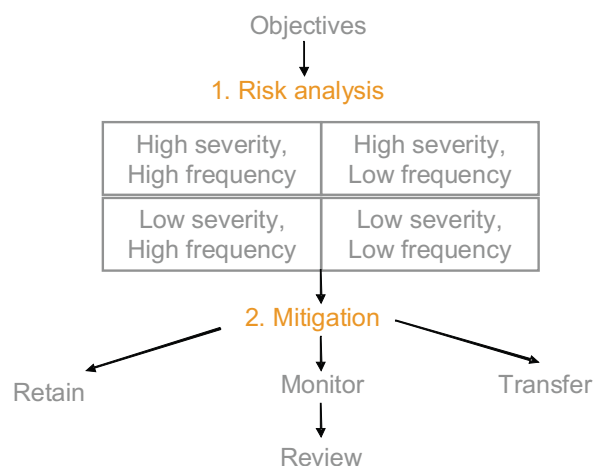

Indemnity

Insurance provides financial protection against the outcome of an unforeseen, pre-defined event. Insurance is a contract between the owner of the commodity, who wishes to avoid or minimize the risk of loss or damage, and the insurance company, which takes on that risk in return for the payment of a premium.

Indemnity is the term used to describe the right to receive compensation for a loss suffered that is covered within an insurance contract. The owner of the commodity must practise risk avoidance, just as the insurance company must indemnify the insured or make good legitimate losses.

It should be noted that not every risk or eventuality can be insured. Insurable risks must be deemed to be unforeseen or chance events. They must also adhere to the principle of 'insurable interest', and the risk must not be against public policy (law or regulation).

Utmost good faith

All insurance contracts are subject to the principle of utmost good faith, which means that the insured must truthfully inform the underwriter of every material fact that may influence the insurer in accepting, rating or declining a risk. This 'duty of disclosure' continues throughout the life of the policy.

Types of insurance cover to protect your business

The types of insurance that might be considered for protecting a business include:

- ❑ **Comprehensive cargo insurance** can include all named physical losses or damage to the cotton, seed, linters or other named goods while the business has an insurable interest.
- ❑ **Property all risks**, which may include all named physical losses or damage to the business's buildings, contents and named equipment while it has an insurable interest.
- ❑ **Money in transit** is aimed at buying agents who carry cash. Money in transit cover from the risks of theft can be included as part of a general cargo policy.
- ❑ **Strike, riot, civil commotion or malicious damage** cover will include physical losses to the insurable interest.
- ❑ **War at sea or on land or terrorism** is physical damage caused by war, whether in marine transit or in storage, and including acts of terrorism.
- ❑ **Non-delivery or non-payment** following political events such as embargo, cancellation of previously valid import or export licence, confiscation of the cotton or non-contractual non-honouring of the contract by a foreign state entity.

Figure 3.4 illustrates the options available to a cotton trader. Cover can be bought in isolation or in combination.

Insurance through the stages of the cotton production process

Through the cotton production process there are many stages at which materials or products pass from one owner to another. Overall the risks to consider at each stage are flooding, fire, lightning, explosion, destruction or damage following strike or riot, theft and burglary. Deterioration due to excessive moisture content, prolonged storage or infestation should be considered, but not all those will be insurable.

Figure 3.4: Insurance options

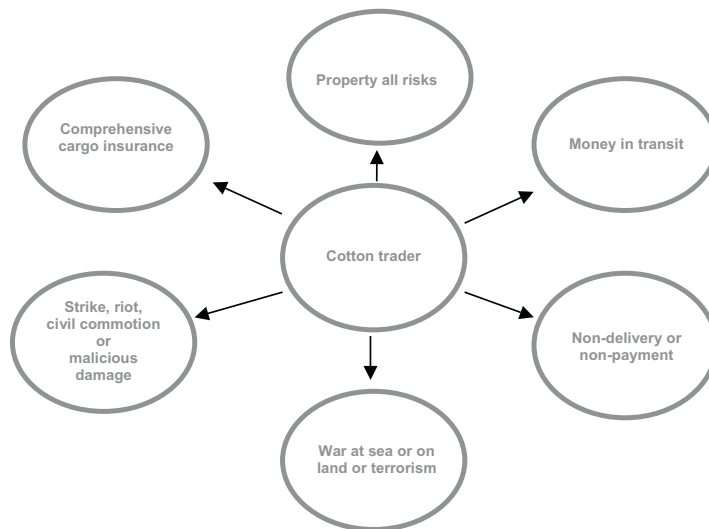

In order to purchase cover, the business must have a valid insurable interest. Figure 3.5 shows a typical supply chain for cotton. Some examples of key considerations at various stages in this process are discussed below, as well as the application of insurable interest.

Figure 3.5: Typical supply chain for cotton

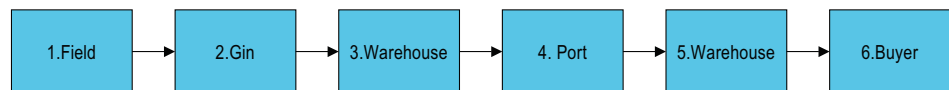

Stage 2 to 3 – Ownership at inland gins or warehousing

At this stage, post-ginned cotton is often wrapped in marked bales with the owner's mark stamped onto the wrapping, which is secured by metal bands. Cotton can be stored within warehouses, or outside on tarpaulins or on pallets. Damage by adverse weather or damage by fire are examples of recognized chance events. It is important to have strong inventory records and controls in order to be able to show exposures.

Stage 2 to 3 to 4 – Inland transit to port or warehouse

Cargo is often moved by independent hauliers or transported by railcar, and therefore shipments should be checked for quality, weight and moisture content. The use of the business's own personnel or designated collateral managers for quality and quantity control should be encouraged to minimize the risk of fraud or receiving damaged cotton.

Stage 2, 3, 4 and 5 – Warehousing

The better the quality of the warehouse and operator the easier it is to obtain cover and negotiate favourable terms and conditions. When providing cover, insurance companies wish to know and understand how the insured business operates. It is important that cotton is stored in an easily identifiable manner, using a numbered bay system in the warehouse with the bay numbers and boundaries painted on the floor. Cotton should always be stored on dry, clean wooden baulks or pallets, off the floor, away from walls.

Exclusions

Ginning

Usually the risk of faulty or improper ginning cannot be insured but there are some measures a trader can take to minimize this exposure. Measures include a strong relationship with the buyer, previous knowledge of the ginner and good quality control.

Exporting

Exporters should bear in mind that at all times the cotton travels and is stored at their risk. There is also the obligation to deliver a particular quality and quantity at a given time and place. Poor management of the risks to FOB may ruin any chance of claiming a mishap on *force majeure*.

When do I become liable? The attachment and termination of risk

Depending on the terms of the contract of sale contract, the insurance may terminate at different stages of the shipping process. This has strong implications for who will be liable for compensation, and therefore who should arrange insurance protection for the goods.

FCA or FOT (free on truck – can be either **CY** or **CFS**). The buyer or its agent nominates the place for the delivery of the goods, pre-cleared for export by the seller, to the carrier at an inland place, probably at the seller's gin or warehouse, or on the carrier's truck. No risk of physical damage or destruction attaches to the exporter after this point, but the exporter remains responsible for errors or omissions that occurred while the goods were under its care and responsibility.

FOB and CFR. The buyer has responsibility for all costs and risk of loss or damage to the goods once they have been delivered by the seller to the named port and have passed the ship's rail. The seller must pay freight costs, and under CFR, must also clear all goods for export.

CIF. In addition to paying the ocean freight the shipper must also arrange and pay for insurance that must be in conformity with the current ICA stipulation: warehouse to warehouse, all risks including SRCC (strikes, riots, civil commotions commodity trade) risk and war risks at a value of CIF + 5%. The seller must contract the insurance and pay premium, but is obliged only to pay the minimum cover. If the buyer requires greater cover, it must either agree this with the seller, or arrange it itself.

Other important considerations

The importance of cover – claims

It is the duty of the insured and whoever is acting on their behalf to:

- Take all reasonable measures to avoid or minimize losses recoverable under the insurance, such as:
 - Cotton fire in storage or whilst in transit
 - Wet damage to bales in storage or transit
 - Rioters destroy bales in storage
 - Theft of cotton bales.
- Ensure that all rights against third parties (warehouse staff, transporters, port authorities, etc.) are properly preserved and exercised.

Available structures for your insurance cover

Open cover

This is the most flexible structure for cover, and for those with varying and ongoing requirements it can work out lower in cost per unit. If you have regular need for insurance, it is usual to seek a cargo insurance contract that is valid for a period of time – usually one year. Within the principal contract, all necessary stipulations are discussed and agreed once, and they apply for the entire period. This means that within its period of validity the cover is always available when needed, subject to the terms of the policy.

Maximum exposure or limit of liability

This cover means that you get back only what you have lost. Typically with open cover, the insurance contract will stipulate the limit of the underwriters' liability to compensate the insured for a single occurrence. The amount of liability may vary depending on each stage of transport or storage. On a case-by-case basis (insurance per certificate), the amount stated in the insurance certificate is the limit of liability.

Extent of insurance – all risks

This cover is bought on an one-off or annual basis. If volumes covered are large enough, this may be the most cost effective option. In reality, however, the phrase 'all risks' certainly *does not* mean that all possible risks are covered. Normal storage and transport insurance principally covers only losses due to physical damage to goods that occurs by chance.

'All risks' normally covers all the physical risks stated within the policy. If an event is not stated it is probably not covered.

Glossary of basic insurance definitions

The scope of any insurance cover is determined by the wording of the policy document. Below are some terms frequently encountered.

Broker. Licensed, authorized intermediary acting on behalf of the insured in arranging an insurance policy, any subsequent amendments and, where required, the negotiation and settlement of valid claims from the insurer.

Condition. Stated clauses within the insurance policy which must be complied with by the insured and/or insurer.

Excess. Pre-agreed monetary amount for which insurers have no liability in the event of a loss. This may also be known as a 'deductible' or 'franchise', which is a pre-determined uninsured percentage.

Exclusions. Events defined within the insurance policy which are outside the scope of the policy.

Indemnity or policy limit. The maximum amount for which underwriters agree to be liable to the insured for any number of agreed events of loss within the insurance policy.

Insurable interest. The insured must own or have an interest in what is being insured. Once a business has paid or pre-paid for cotton or other goods this principle is established (provided that in the event of the loss of the goods the business can show a direct financial loss).

Insured. Party with an insurable interest in the item at risk.

Insurer. The licensed and authorized provider of a pre-agreed indemnity policy, being the contract of insurance.

Loss adjuster. Specialist claims intermediary appointed by the insurer to assess the validity and quantum of any claim amount.

Period of cover. Clear stipulation of the designated dates and times between which cover is provided or is effective; loss experienced outside that given timeframe is not covered.

Premium. The agreed monetary sum payable by the insured to the insurer to validate the insurance policy.

Warranty. A clause within an insurance policy which, if (in the opinion of the insurer) ignored or broken by the insured, may cause the insurance policy to be invalidated.

Risk management – A cotton supply chain manager’s perspective

Risk

Risk can be simply defined as exposure to uncertain events. Examples of ‘uncertain events’ include:

- Strike in shipment port;
- Flood or drought in cotton growing areas;
- Default on contractual obligation by a buyer or supplier;
- Fire in the cotton warehouse;
- Sharp increase in cotton prices;
- Poor quality of cotton crop.

Risk management is an effort to proactively manage the uncertain events. The idea is not to eliminate uncertainty but to set up processes to actively identify and control uncertainty and to manage it within agreed exposure limits that can be decided based on the organization’s financial ability or desire to deal with risk events.

Risk management has gained currency in the last one and a half decades. The primary reasons for the rapid growth of risk awareness are:

- High-profile corporate financial failures. These have brought a pervasive negative perception of corporate behaviour and shifted the onus on to companies to demonstrate sound risk management and governance practices.
- Market fixation on achieving short-term results.
- Legislative changes in corporate governance (Basel II norms, Sarbanes Oxley etc.).
- Rapid growth in trading volume of derivative products such as futures and options.

Risk management framework

Figure 3.6 below highlights the sequential steps required to institutionalize a risk management framework in an organization.

Identification of risk. Identify the key risks in a business. For example, the key risks for a cotton supply chain player are cotton outright price risk, cotton

basis risk (physicals prices with respect to futures), credit risk, counterparty risk on unshipped purchase/sale contracts, documentation risk (for L/C negotiation), currency risk etc.



Figure 3.6: Risk framework

only then), systems and processes should be implemented to capture risk data, measure the quantum of risk, and review, monitor and report risk exposure with respect to approved limits.

Aligning systems. Aligning performance evaluation systems and annual incentives is the most crucial aspect in effective implementation of a risk management framework. This provides the crucial link in developing a healthy risk culture and communicates top management's efforts to maximize returns in relation to risks.

Risk governance

Governance structure

An ideal risk governance structure is characterized by independent external assurance as well as internal management assurance as shown in figure 3.7.

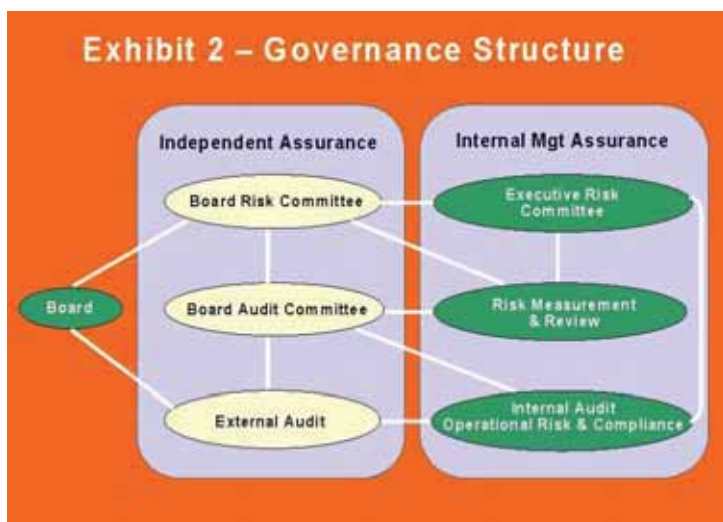

Figure 3.7: Governance structure

Risk control policies and procedures. Implement risk policies and procedures for managing the risks identified above. The business should also set up risk review mechanism to ensure adherence to risk management policies and constantly update risk control policies to adapt to new categories of risk.

Risk limits and risk capital allocation. The board of the company should decide the overall risk capital that the company is willing to stake. The company management can then allocate this risk capital (or risk limits) to the various business segments at unit level.

Risk capture, measurement and reporting. After the risk limits are finalized (and

External assurance

The board level risk committee should be the apex body for risk management. An external director should head this committee. The committee should be responsible for setting direction for market risks (outright, basis and currency), and credit and counterparty risks.

The board audit committee should also be headed by an independent director. This committee should oversee the operational risks associated with the company. The board risk committee and board audit committee should have members in common to prevent any gaps in governance process.

The external auditors should do an annual audit of the risk management processes of the company and ascertain the sufficiency of risk management practices for the company's level of operations.

Internal assurance

The executive level risk committee should be the apex management body for risk management in the company. This committee is responsible for driving risk management policies and procedures across the company for price risks (outright, basis and currency), and for credit and counterparty risks. The risk office should be represented in the executive level risk committee.

The internal audit team should be responsible for auditing the operational risks of the company, including the operational risk in implementing risk management processes.

Segregation of duties

The risk control process should be demarcated into front office, risk middle office and back office for all transactions, particularly those pertaining to futures and options. This is to ensure that:

- ❑ All trades are recorded in the company systems;
- ❑ Brokers' P/L and M2M are calculated independently;
- ❑ Traders are not able to make margin settlement directly.

The front office, consisting of product teams, should enter all futures and options transactions within 12 working hours of the transaction. The risk middle office should reconcile these trades with the daily broker recaps within one or two days of the transactions. Based on the reconciliation, risk middle office can calculate broker margin requirements, and send the margin settlement details to back office daily for the concerned brokers.

The back office (treasury) makes final payment to the brokers based on the instruction from risk middle office.

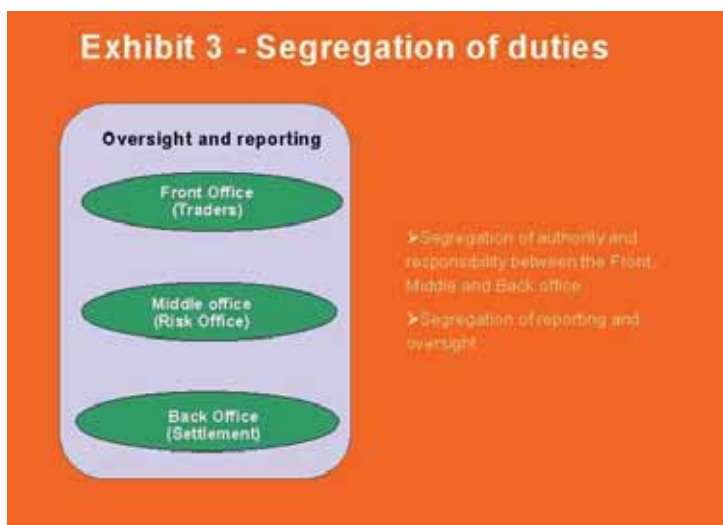

Figure 3.8: Segregation of duties

Risk measurement

Since risk is an exposure to uncertain events, for measuring quantifiable risks the following steps have to be taken:

- ❑ Ascertain current exposure – captured through suitable systems.
- ❑ Measure uncertainty or volatility based on historical data – standard deviation of changes in historical prices of a commodity.

Value at Risk or VaR is the metric for measuring market risks (price, basis and currency). VaR can be defined as the maximum loss a reference set of instruments (or portfolio) can incur based on historical data and given a chosen confidence level.

For example, if VaR for a portfolio is \$1 million, then the portfolio’s loss should not exceed \$1 million with a 95% confidence level. In other words, there is a 95% probability that loss will be in the range of 0-\$1.5 million.

The steps for measuring VaR are as follows:

- ❑ Determine the portfolio holdings – for example a cotton portfolio can consist of components like West African physicals, United States physicals and cotton futures across various terminal months in CSCE (Coffee, Sugar and Cocoa Exchange).
- ❑ Calculate the standard deviation for each component.
- ❑ Calculate the correlation of each component with respect to all other components. For example if there are three components C1, C2 and C3 in a portfolio, then correlation has to be calculated for C1 & C2, C1 & C3 and C2 & C3.

$$\sigma = \sqrt{\sum_i (s_i \sigma_i)^2 + 2 \sum_{i,j} s_i \sigma_i s_j \sigma_j \rho_{i,j}}$$

- ❑ Calculate VaR by applying the general result.

In the above example, σ is the standard deviation of the portfolio in dollar terms, s_i is the component holding in quantity terms, σ_i is the standard deviation of component in dollars per ton terms, and ρ_{ij} is the correlation factor between two components.

Multiply the portfolio ρ by the requisite confidence level (CL) to calculate VaR. For example, to calculate VaR for 95% CL, multiply σ by 1.645 and for 99% CL multiply by 2.33.

The VaR numbers and quantity exposure should be compared with the risk limit (both VaR and quantity) for ongoing risk control.

Price charts – Cotlook A Index and New York Cotton Futures

Figure 3.9: Price chart

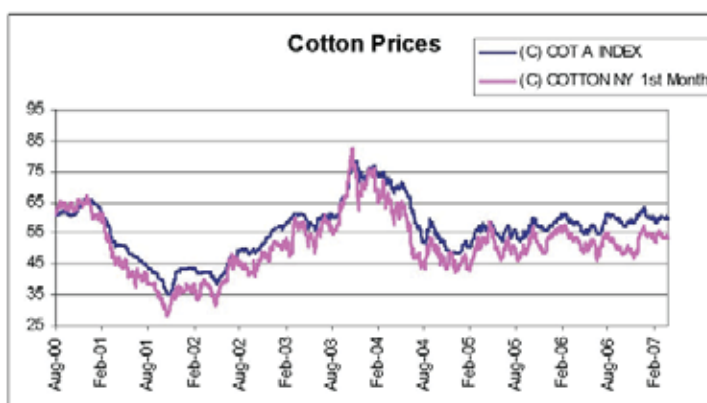

Correlation (with a 1 day lag)	67%
Futures first month 1 day volatility at 95% CL	3.31%
Cotlook A Index 1 day volatility at 95% CL	1.41%

The basis (or difference) between Cotlook A Index physical prices and New York first month futures has fluctuated in the last seven years as shown in figure 3.9.

The range of basis prices, computed as Cotlook A Index Price minus Futures first month is as follows:

<i>United States cents per pound</i>	
<i>Min</i>	<i>(4.54)</i>
<i>Max</i>	<i>14.55</i>
<i>Range</i>	<i>19.09</i>

Stress testing

Stress testing is:

- Examination of low probability events that could result in extraordinary losses or gains;
- Examination of key sensitivities that might emerge in a trading book.

Stress testing is an attempt to gauge the vulnerability of the portfolio when subjected to hypothetical events. It is done because of the need to find the non-linearity of the portfolio under conditions of duress. Stress testing incorporates external events (such as SARS and its impact on suppliers to the bird feed industry). It is a natural complement to VaR – stress testing is able to quantify the magnitude of low probability tail events that VaR cannot quantify.

Stylized scenarios are simulated movements in the major risk factors. These movements can range from relatively moderate to extreme, and can be expressed in terms of absolute changes, percentage changes or standard deviation units. For example, one can simulate a scenario by assuming a 10 cent per pound change in cotton prices, or 30% change in cotton realizations. Similarly one can also consider an extreme 5 or 10 standard deviation change in the cotton prices.

Scenarios can be constructed from actual extreme events (such as the stock market crash of October 1987 or the bond price falls of 1994). The best way to do this is to select scenarios of the same order of magnitude as the worst-case historical events.

Another methodology for stress testing is known as *factor push analysis*. In this methodology the prices of each risk factor are pushed in the most disadvantageous direction, and the combined effect of all such changes in the value of the portfolio is calculated. At first a confidence level, say α , is specified. Subsequently each risk factor is considered on its own and pushed by α times its standard deviation. Then the price movement up or down that has the worst effect on the value of the portfolio is selected (for example, for long positions push the prices down and for short positions push the prices up).

Back testing

Back testing is revalidating the efficacy of the business's VaR framework. This is done by verifying that actual price movements are within the probabilistic price movement calculated by the VaR model of the company.

Back testing provides a statistical measure for ascertaining whether the VaR model used by the company is suitable for its operations. It can highlight products where the actual price movement is higher than the price movement calculated by the VaR model.

Counterparty risk

Counterparty risk is defined as risk arising due to non-performance of contracts by the suppliers or customers. Examples are:

- Cotton supplier not shipping when cotton prices increase sharply;
- Customer not opening L/C when cotton prices drop.

There are two main ways to manage counterparty risk:

- Classification of counterparties.* Counterparties should be classified into risk category buckets based on the following factors:
 - Location of the company (thereby taking into account country risk);
 - Availability of financial information and rating from external agencies;
 - Track record of dealing with the company and assessment of the party's ability to bear losses.
- Fixed price quantity limit.* For non-futures products this is the only limit that needs to be monitored. For futures products, fixed price quantity limits includes fixed price contracts as well as differential contracts that have been price-fixed by the buyer or supplier in the futures terminal. The fixed price quantity limit for the counterparty is set taking into account the following factors:
 - Risk category for the counterparty as classified above;
 - Estimated annual trading volume of the counterparty and the expected margins from it;
 - Ability of the product to enforce claims.

Operational risk – mapping

Operational risks relate to:

- People;
- Operating systems and processes;
- Inventory and other assets;
- Documentation;
- Statutory and legal requirements;
- Reputation.

The organization should be able to map the operational risks for a business activity and devise suitable risk control and monitoring mechanisms. Some of the tools that can be used for tracking operational risks are operational risk scorecards, event diaries and learning notes.

A sample methodology for mapping operational risk in supply chain management for delivery of cotton is illustrated in figure 3.10.

Risk culture

Risk culture is the crucial link or software that binds the hardware of risk management framework. A positive risk culture is one where:

- People ask difficult questions;
- People admit ignorance;
- Whistle blowing is encouraged;
- Performance evaluation of businesses and people are based on risk-adjusted returns and not on absolute profit levels.

Sound risk management and governance processes will eventually lead to maximization of shareholder value.

Figure 3.10: Risk control system

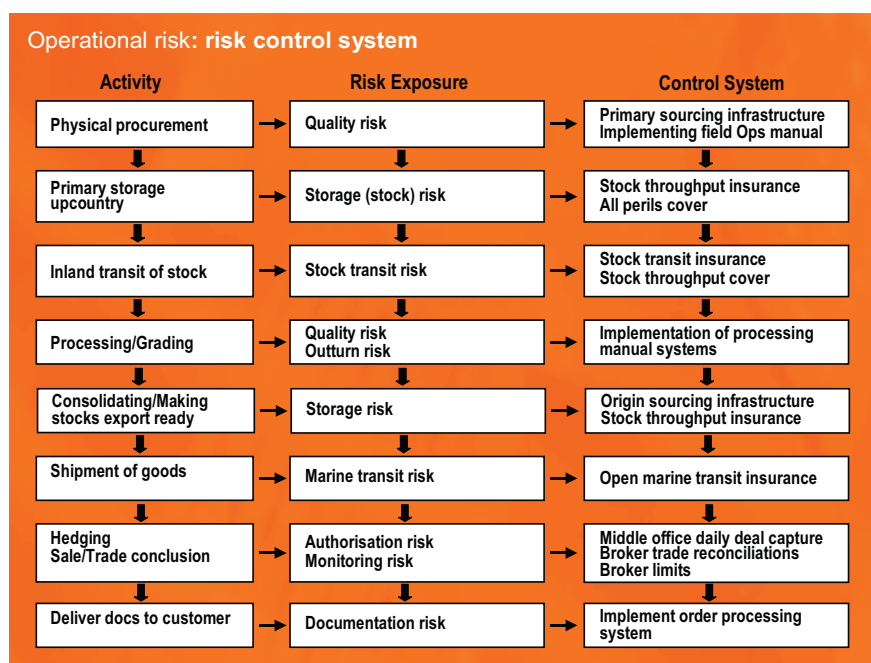

Cotton promotion

The importance of cotton promotion

Promotion is critically important to the cotton industry to enable it to regain market share from polyester. Globally, cotton's market share has eroded to about 40.6% from 50% in 1986, and polyester's market share has grown to approximately 42%. Cotton consumption, however, has grown since 1998, and the current years are the longest and most substantial cotton expansion period on record. Cotton's market share also showed a modest positive increase for 2005, the first in quite some time, but that is largely attributed to a price advantage over polyester.

Polyester is cotton's most significant competitor in the textile industries. Polyester competes with cotton on price, research and development of new products and new product variations, manufacturing efficiencies, and some categories of consumer performance, such as wrinkle resistance and physical durability. Cotton is usually the consumers' choice because it is soft, comfortable, natural, sustainable and renewable. Appealing to consumers' emotional preferences makes cotton promotion a viable way to improve cotton's market share.

Producing countries, trading countries, and consuming countries

Producing, trading, and consuming countries participate in cotton promotion. Producing and producing/consuming countries tend to take the leading role in promotion activities, with United States cotton organizations being the most active. Other countries that actively promote cotton include Australia, Egypt, India and South Africa. Producing countries that have begun, or are about to begin, promotion efforts include Brazil, Colombia and Turkey. Usually countries beginning promotion enter through low and medium cost activities, but sometimes move to higher cost activities, depending on funding and support structure.

Trading countries and trading/consuming countries, such as Germany, Poland and the United Kingdom, participate in middle cost and low cost activities, such as fashion shows, education programmes, contests, and publicity. Germany, through the Bremen Cotton Exchange (Bremer Baumwollbörse) manages a logo identification programme, as does Poland through the Gdynia Cotton Association (Izba Bawelny W Gdyni).

Some countries, such as Italy, Spain and Zimbabwe, have very little active promotion, but support the international organizations that promote generic cotton through membership and sponsorship.

International, national, state and private sector promotion programmes

Cotton Incorporated, the marketing and research company of United States cotton producers, reversed cotton's eroding market share in that country, which hit bottom in 1975 at 34%, by speaking directly to the consumer, and by working with the textile manufacturing supply chain to improve cotton's manufacturing competitiveness. While the programme was successful by every measure and cotton had begun to significantly regain market share by 1983, other countries have not followed suit, largely because of lack of budget. Australia has developed many interesting promotion techniques, including a retail operation focusing on offering cotton products, and combining various promotions with education; but the severe drought and textile manufacturing moving offshore over recent years has impeded the ability to sustain these efforts.

State and private sector funded and focused programmes are thought to be the next fertile sectors for cotton promotion activities. State programmes may be easier to facilitate, and private sector consortiums have fewer bureaucratic hurdles involved in the implementation.

Generic and branded cotton promotion

There are two types of cotton promotion. One country simply promoting its cotton against another country's is one type, and the other is to promote all cotton against chemical fibres, recognizing that the true competition is polyester.

The end-product retailer and consumers understand cotton branding primarily as country of origin. Some cotton organizations, however, will differentiate themselves by conveying the idea that specific cotton varieties can deliver some benefit to the consumer, and will communicate that benefit through the application of a visual logo or other icon. The benefit implied might be that the product meets a quality standard, a set of industry specifications, or perhaps was subjected to processes that will deliver important value to the consumer. Logos are also used to identify fibre content blend type or fibre blend level, with different criteria for the consumer depending on the individual programme focus. Most logo programmes have at least two versions of the icon to identify the product as either 'pure cotton', or a blend level limit.

To some organizations, 'pure cotton' will mean 100% cotton while to some, 95% cotton content is considered 'pure'. Blend levels for specific end-uses will be determined by the amount of other textile fibre that is required to support cotton in delivering an intended benefit to the consumer, and that intended benefit could be for a variety of end-uses. Examples of different blend levels to reach different end results would be the difference between the minimal amount of other fibre needed to achieve stretch, versus the larger amount of other fibre required to deliver wrinkle resistance, based on weight of fabric.

These logo programmes are usually managed in several forms of licensing agreements, administered by non-profit organizations with directors made up of industry participants, and others who have an interest in the well-being of the cotton industry.

Another example of cotton branding is through fibre length. Long staple and extra long staple *G. barbadense* cotton species have developed a consumer following with premium positioning, based on hand, lustre, texture and strength. While specific varieties command a price premium from fibre to consumer, they represent a very small portion of worldwide cotton production and consumption.

Advances in fibre and fabric technology along with quality consistency improvements throughout the entire textile supply chain have created a competitive price-sensitive marketplace, making it more difficult to differentiate between different varieties of cotton in the end-products. The more consistency improves, the more the cotton industry focuses on generic cotton promotion, as it becomes clear that the competition is chemical fibres, polyester in particular, and that sustainable growth for the cotton industry must come at the expense of synthetics.

Toward that end, the industry has set up a forum for the exchange of ideas, which acts as a clearing house to evaluate promotion techniques meant to improve cotton's market share at the retail level. The International Forum for Cotton Promotion (IFCP) is a non-governmental organization composed of regional, national and international cotton industry organizations and sponsors, with 18 members from 14 countries. The mission of IFCP is to encourage increased consumer demand for cotton through the implementation of national, state, and private sector cotton demand enhancement programmes. IFCP serves as a clearing house for information about proven techniques of cotton promotion, best practices in retail-level communication, and cost-effective measures of boosting consumer demand.

IFCP was established in 2000 in recognition of the need for a proactive effort on behalf of the cotton industry to increase cotton's share of domestic fibre markets at the consumer level. It does not promote cotton, but rather promotes the promotion of cotton. It has created a website, focusing on cotton promotion, for anyone interested in pursuing or learning about what it entails. See www.cottonpromotion.org.

There are other generic cotton promotion efforts, including the Cotton Gold Alliance, a programme intended to increase cotton demand in India, and Cotton: Beyond Your Imagination, to achieve similar results in China. These programmes do not feature one country's cotton over another's, and are meant to stimulate demand for all cotton.

The notion of having an international body that would actually collect funds and implement advertising and promotion of cotton fibre in major consumer markets outside the United States was attempted from 1967 through 1994. The International Institute for Cotton (IIC) was composed of the governments of as many as 14 producing countries. IIC's mandate was to promote retail consumption of cotton in Europe and Japan. IIC was effective, but government support proved unsustainable. Based on that experience, it is unlikely that a similar venture will be attempted again in the near future.

Demand enhancement vs promotion

The world price of cotton and carry-overs are not considered or factored into demand enhancement activities, and nor are trade issues or legislative issues, unless they directly affect the effectiveness of cotton demand. The term 'demand enhancement' is used to describe this activity, as 'cotton marketing' is

usually perceived to pertain to lint fibre trading activities, and ‘promotion’, while used frequently, must be clarified in some parts of the world, as it might imply price-cutting activities.

Demand enhancement implies that market share can always be improved by creating positive activity at the retailer and consumer level, and that several small activities together can result in a meaningful larger programme producing a measurable impact.

Textile fibre promotion activities are usually tied to the revenues produced by cotton fibre sales, usually based on an agreed assessed fixed price amount per bale, plus a percentage of the selling price, in order to fund promotional activities. Sometimes imports, exports or both are taxed, thus improving revenues, and increasing the range of activities possible. Since most organizations resist pooling funds for overall broad-brush cotton promotion, this manifests itself in various self-standing promotion activities, rather than a well-orchestrated series of events that could conceivably result in a lasting impact.

Generally speaking, true promotional activity tied to the bottom line (including price cutting for front-loading promotions) is best suited to businesses that have clear brand differentiation and clear ways to evaluate the impact on the individual brand or business. Demand enhancement is better suited to commodities that have few ways to distinguish themselves from their inter-industry competitors other than price, and that have realized that overall market share improvement is necessary to sustain long-term growth for the entire industry.

Export focused promotion and domestic promotion

Export focused cotton promotion programmes are based on the ability of a cotton producing country to supply cotton to textile manufacturing countries or regions that are net importers of cotton. This usually occurs when the producing country does not have textile manufacturing capability, or produces more cotton than the producing country’s manufacturing capacity can consume. With the relocation and reorganization of the world’s textile manufacturing complex, country and regional configurations are changing. Some countries that previously were cotton producing, textile and apparel manufacturing and consuming countries are now cotton producing and end-product consuming countries, as textile and product manufacturing has relocated elsewhere. China, for example, is the world’s largest producer of cotton, the world’s largest producer of textiles and apparel, and still is a large net importer of cotton from other countries.

Some countries that were always net exporters of cotton must now compete differently, because of a stronger focus on world price and unforgiving quality consistency demands. Most focus on price promotion, rather than trying to differentiate ‘cotton from other cotton’, unless there is a perceived built-in competitive advantage for the consumer.

Domestically focused demand enhancement programmes are built on the premise that cotton consumption can be increased by improving demand within the countries of the stakeholders of cotton activity, including producing, trading, manufacturing, and consuming countries and organizations. If every country or region increases demand within its own borders, cotton consumption will also increase, thus benefiting the entire industry. There are several advantages to domestically focused promotion, including the ability to manage the scope of that promotion for effectiveness, and the ability to control the competitive landscape more successfully. Working in a familiar market presents strong advantages, including a better understanding of the culture, the target consumer, and ways that will help influence fibre preferences more easily, effectively and with limited resources.

The cost of cotton promotion

Cotton promotion activities can be segmented into high cost, medium and low cost activities. The perceived cost of cotton promotion activities is an important barrier that must be overcome when beginning a promotion programme. Without question, well-funded cotton promotion programmes have the ability to be more effective in a shorter period of time, but there are many activities that are inexpensive and effective.

High cost promotion activities

- Developing logo programmes including support systems to make the promotion effective;
- Consumer broadcast campaigns;
- Consumer print advertising campaigns;
- Programmes that involve certification;
- Trademark programmes that require registration in many countries, including support and enforcement mechanisms;
- Programmes that offer technical assistance;
- Programmes that require exploratory, descriptive and causal research;
- Programmes that require extensive travel;
- Programmes that rely on contracting established professional task-specific firms;
- Comprehensive public relations initiatives.

Medium cost promotion activities

- 'Cotton Day' activities;
- Tie-ins with cause marketing or retail efforts;
- Cotton promotion workshops;
- Trade print advertising (usually less expensive than consumer print);
- Cooperative and payment-in kind-programmes;
- Hang tag and label programmes;
- Fashion shows;
- Billboards and posters;
- In-store product displays;
- Trade booth.

Low cost promotion activities

- Logos as identification, with no claims or enforcement;
- Sponsorship programmes;
- Working with higher education;
- Publishing in trade journals and conferences;
- Printed educational materials;
- Publicity;
- Websites;
- Design contests;
- Visibility/speaking engagements;
- Education.

Promotion strategy

Most cotton promotion combines push and pull communication strategies.

In a 'push' strategy, the product flow and the communication flow run parallel as seen in Figure 3.11. The push strategy has a direct customer focus, is usually based on manufacturing efficiency, and relies on the manufacturing supply chain to promote the product. The 'push' strategy relies on price.

In a 'pull' strategy, the product flow follows a linear process, but communication flow moves forward in the supply chain. The focus is on the end-user, or on the final consumption product, and the unique selling proposition (USP) is usually based on consumer benefits, or retail selling issues. The 'pull' strategy also frequently requires front-loading the promotion, which can require a significant cash outlay.

Most cotton promotion employs a combination of both the push and pull strategies, to get the benefits of both. This combination enables the promotion effort to convey messages directly to the consumer, while at the same time providing technical support to the supply chain, including product and service providers.

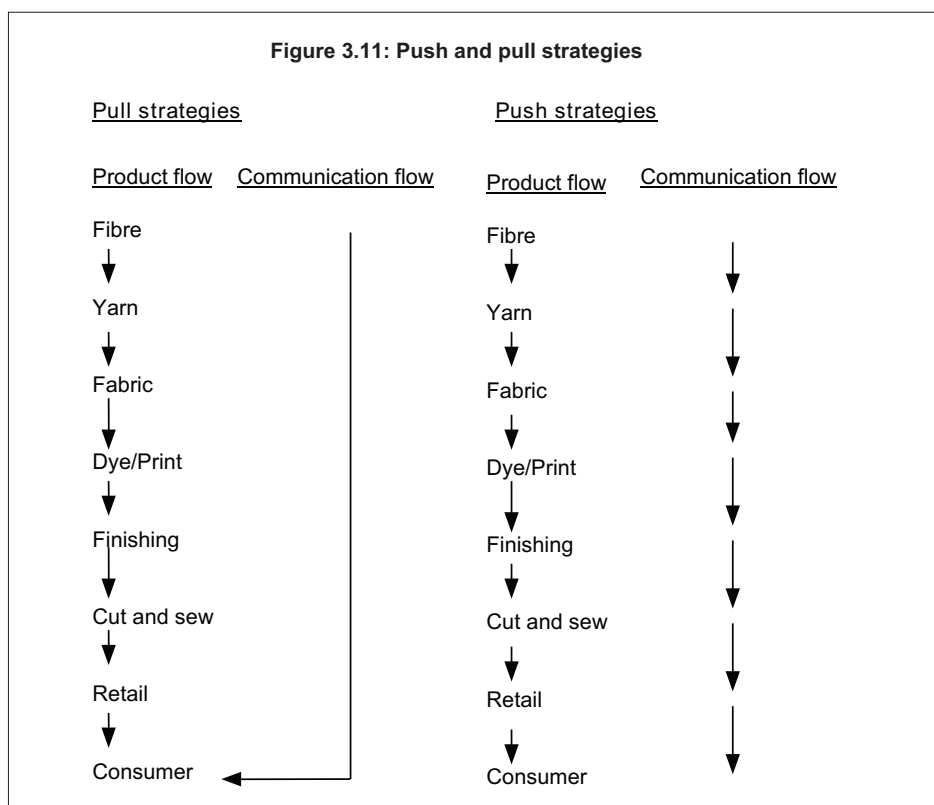

Factors that can affect promotion

Quality, quality consistency and quality assurance can influence promotion in a positive way. In a price competitive market, quality consistency makes it more difficult to identify differentiating features in the end product, but quality assurance adds value, and can be offered as a provided service. Quality also contributes to a promotion programme, in that it is easy to promote good quality, but nearly impossible to promote a product of inferior quality.

Research and development and new product development functions have different objectives in the cotton and textile industries, but the focus and importance placed on each is critical to successful cotton promotion. Research and development indicates to the supply chain that, regardless of what improvements chemical fibres can offer, natural fibres can do the same and better. New products make those improvements tangible. Both research and development and new product development provide substance for cotton promotion.

Economic conditions have a strong impact on cotton promotion, and cycles can be maximized. When the world economy is weak, that is the time for research and planning for better times. When the world economy is strong, cotton promotion has the advantage of its own profitability, but also the knowledge that the support industries will have the ability to consider investing promotional resources in a strong market showing growth and growth potential.

When fibre prices dip, that is the time to aggressively promote cotton, and position the industry for when the prices firm up. Low fibre prices can mean that the textile manufacturing complex is probably adding new cotton-rich products, or is amenable to doing so, including changing blend levels in cotton's favour. However, the reaction of many industries is usually to cut back on promotion during difficult economic times, and that is the case with cotton also.

Fibre content labelling is an important issue, but difficult to fix. No matter how visible the promotion, if the consumer does not know what the product is made of, the consumer can't buy what he or she wants. A research study conducted by the Strategic Planning Department of Cotton Incorporated in 2003, found that in an initial sample of 166 countries, detailed information could be gathered on 73 countries and there was no information for 76 countries. Only 59 of 166 countries (36%) have known labelling laws, only 49 countries (30%) have known apparel fibre content labelling laws, and only 47 countries (28%) have known home textiles fibre content labelling laws. In many parts of the world, the label is not a true indicator of the true fibre contents. This will affect fibre consumption negatively, even if fibre demand is influenced positively.

The more a retail community within a country is organized, the easier communicating with the consumer will be, and the more likely it is that a cotton promotion effort can be implemented. Usually more developed countries have established communication channels. When retailers of cotton products are not organized geographically or demographically, especially in developing countries, the mechanisms for creating cotton promotion are not in place, and the retail level of the supply chain becomes an obstacle rather than a partner in the effort. Not being able to communicate through retail can be overcome by working with municipalities or by communicating directly with the consumer, but the chance of a measurable success is lessened.

Changes in market share or in the competitive landscape will affect the level and type of promotion. Usually a significant drop in market share precipitates action by those affected, and that begins cotton promotion activity.

Annex

ICA model contract

The International Cotton Association Limited International Shipment Contract Form 1

Cost Insurance and Freight (CIF), Cost and Freight (CFR),
Free on Board (FOB) and other similar terms

This form is intended for use by Principal Firms and their Related Companies



From Dear Sirs, We have:	To BOUGHT the following from you today <input type="radio"/> (please tick one box and delete the other statement) SOLD the following to you today <input type="radio"/>
Contract Number _____ Agent _____	Date _____
1 Growth And Quality <i>See Condition 1</i>	
2 Micronaire <i>See Condition 2</i>	Minimum _____ Maximum _____ Control limit _____
3 Strength <i>See Condition 2</i>	Minimum _____ <ul style="list-style-type: none"> • Opsi 0 gauge Pressley • Ograms/tex $\frac{1}{16}$ gauge HVI calibrated with HVI calibration cotton (please tick one box and delete the other statement) Control limit _____
4 Quantity <i>See Condition 3</i>	Average weight of each bale _____ Variation allowed _____ %
5 Price and terms	6 Weight basis
7 Payment	
8 Shipment <i>See Condition 4</i>	
9 Freight	The current rate is _____ If it is different at the time of shipment: (please tick one box) <ul style="list-style-type: none"> • O you must pay the difference. • O we will pay the difference.
10 Export duty or subsidy	of _____ % is included in the price. If it is different at the time of shipment: (please tick one box) <ul style="list-style-type: none"> • O you must pay the difference. • O we will pay the difference.
11 Insurance	Insurance will be arranged in line with condition 5a <input type="radio"/> 5b <input type="radio"/> 5c <input type="radio"/> 5d <input type="radio"/> on the other side of this form. (please tick one box)
12 War risk	The current rate is _____ %. If it is different at the time of shipment: (please tick one box) <ul style="list-style-type: none"> • O you must pay the difference. • O we will pay the difference.
13 Special clauses	

Continued over the page

14 General

- This contract incorporates the bylaws and rules of the International Cotton Association Limited as they were when the contract was agreed.
- The conditions below are an integral part of this contract.
- This contract cannot be changed unless we agree in writing.
- This contract cannot be cancelled for any reason.

15 Arbitration agreement

- **All disputes** relating to this contract will be resolved through arbitration in accordance with the bylaws of the International Cotton Association Limited. This agreement incorporates the bylaws which set out the Association's arbitration procedure.

Note: If we agree, the words 'All disputes' can be changed to read 'Quality disputes' or 'Technical disputes'. But if nothing else is agreed, the words 'All disputes' will apply.

- You must not take legal action against us over a dispute suitable for arbitration, other than to obtain security for any claim, unless you have first obtained an arbitration award from the International Cotton Association Limited and exhausted all means of appeal allowed by the Association's bylaws. This also applies to us.

Our signature**Your signature****Contract Conditions**

- Growth and quality** All cotton provided must be of even running quality. (ICA Rule 228)
- Micronaire and Strength**
Unless we agree otherwise, any dispute about micronaire will be settled under ICA Bylaws 339 and 340, and any dispute about strength will be settled under ICA Bylaws 341 and 342. If we have not agreed percentage allowances or the use of market differences, or a control limit, the percentage allowances or control limit in the bylaws will apply.
- Quantity** Unless we agree otherwise, cotton is to be supplied in high density compressed bales.
- Shipment**
The seller must get any export licence necessary.
The buyer must get any import licence necessary and must tell the seller that he has this licence before the first permitted shipment date.
- Insurance** (ICA Rules 205 - 209)
According to whichever box is ticked in Section 11 of this form:
 - The seller must take out marine cargo insurance covering risk to the mill or warehouse, war risks insurance, and strikes, riots and civil commotion's insurance for the invoice value plus 10%. The seller must take out this insurance through Lloyd's or another first class insurance company; or
 - The buyer must take out marine cargo insurance, war risks insurance, and strikes, riots and civil commotion's insurance for the invoice value plus 10%. The buyer must take out this insurance through Lloyd's or another first class insurance company; or
 - The seller will be responsible for insuring the cotton until it is delivered to the shipping company or its agent; or
 - The seller will be responsible for insuring the cotton until it is loaded on the ship.
 In the case of (b) and (d), the seller must tell the buyer the ship's name as soon he knows it.
 In the case of (c), the seller must tell the buyer the date of delivery as soon as he knows it.
 The buyer is responsible for marine insurance on any amount over the invoice value plus 10%.
- Quality differences and quality arbitration** (ICA arbitration bylaws, especially Part 2)
International Cotton Association official differences will apply unless we agree otherwise. If the quality of the cotton is not as it should be, the seller must pay the buyer an allowance. We will try to agree the amount with you. But if there is no agreement, the dispute must be resolved through quality arbitration under the bylaws of the International Cotton Association Limited.
 If quality arbitration is required, samples for arbitration must be taken within 42 days of the date of arrival of the cotton. Arbitration must be commenced in line with ICA Bylaw 319 within 49 days of the date of arrival of the cotton. Samples must be sent off to the place of arbitration within 70 days of the date of arrival of the cotton. (ICA Bylaw 325)
 These deadlines can be extended if we agree, or an application can be made to the International Cotton Association for an extension under Bylaw 325. Each lot will be treated separately for arbitration.
- Shipping documents**
The seller must give the buyer a detailed invoice within 14 days of the date of the clean onboard bill of lading or other negotiable document of title.
 The required shipping documents are:
 - a full set of clean on-board bills of lading or other document of title. The document must show the buyer's name and address as the consignee. Otherwise, the consignee must be shown as 'To order' and blank endorsed;
 - a minimum of three copies of the invoice signed by the seller which sets out the total weight, the amount of tare and the total weight less tare; and
 - under CIF terms only, a marine cargo, war, and strikes, riots and civil commotion's insurance risk insurance policy or certificate.
- Weight**
Provisionally, the cotton will be invoiced on shipping weights. If net landed weights are stipulated, tare must be allowed for. If net landed weights are stipulated and the net landed weight of the cotton is different, the seller must compensate the buyer or the buyer must compensate the seller, as appropriate.
- Tare**
If the buyer thinks that the seller has not allowed enough for tare in the invoice, the actual tare can be established under Rules 214 and 215. The seller must not use sisal bagging.
- Claims**
Claims under Rule 230 for false packed, mixed packed or plated bales, for unmerchantable cotton and for foreign matter must be made within 6 months of the date of arrival of the cotton. Notice of any claim under Rule 231 for country damage must be given in accordance with Rules 206, 207 and 231. Unless we agree otherwise, all claims (including insurance claims) must be settled in the country the cotton is delivered to. Claims must also be settled in the currency of the contract.
- Damage**
If the cotton arrives country damaged or having damage which appears to have been caused before shipment, we must try to agree on a settlement in accordance with Rule 206 or 207, as appropriate.

*You can buy copies of the International Cotton Association's bylaws and rules from Secretary of the Association at
620 Cotton Exchange Building, Liverpool L3 9LH, England.*

CF1 (1/08)

Chapter 4

Cotton trading

The role of merchants in cotton exports

It might be tempting to think that cotton merchants have an easy job. They do not grow cotton, they do not gin cotton, and they do not spin it. Are they not just intermediaries who buy and sell? Because trading is their job, they must surely know whether prices will go up or down, and therefore it must be easy to make money out of doing very little. Exporters might be farmers, ginners, cooperatives, privately owned traders or government departments, or indeed a combination of two or more of these. Why should they not sell their cotton direct to overseas spinners? By cutting out the intermediary will they not be able to obtain a better price for their cotton?

In order to answer these questions it is necessary to understand the role of the merchant, which is a complex one.

The cotton market is geographically very diffuse. Although China is easily the largest importer, it still accounts for less than 40% of all global cotton imports. More than 70 countries account for the balance of over 60%. The larger international merchants have offices or agents in all the major importing countries. It is the job of these offices and agents to make regular visits to the spinning mills in their territory in order to find out when the mills are in the market and for which qualities. They will then do their best to negotiate sales to those spinners. However it is a sad fact of life that not all businesses are reliable, honest, and financially sound. The agent must judge which spinners fall into this category.

The fact that spinners are spread so widely across the world means that they are located in many different time zones, and of course they like to trade during their own office hours. Traders in a merchant's office accept that theirs is a 24/7 business. They have to be ready to take calls out of normal office hours and they know that they may be woken during the night. The plans soon to extend to 22½ hours the daily trading hours on the IntercontinentalExchange (ICE) are likely to intensify this pressure on international traders.

Time plays a part in the merchant's role in another respect, the timing of purchases and sales. Exporter suppliers seldom want to sell at the same time as the merchant's spinner customers want to buy. In some countries the farmers need loans well in advance of harvest time in order to pay for inputs such as pesticides and fertilizers. Often the banks will make such loans only if the farmer, or the organization that exports on behalf of the farmer, can provide evidence of sale contracts to a party which the bank knows to be reliable. Therefore farmers in these countries may need to make sales well in advance of the crop. In other countries, such as Brazil and Australia, producers may sell as much as two, or even three, years ahead if the price looks profitable to them. Few spinners would want to commit themselves so far ahead, but a reliable producer will nearly always be able to find a merchant who is willing to make a

price and enter into a contract. Merchants may hedge their risk by making a sale of New York futures, or may cover themselves by selling the same cotton, or a completely different cotton, for an earlier shipment. They must use their experience and judgement to decide what the difference in price should be between the physical cotton that they have bought and the cotton or futures that they will sell. They may even decide not to make a sale at all in the belief that the price will eventually go up. There may be people who will say with disapproval that this sort of trading is speculation. However, without 'speculating' merchants, producers would not be able to sell their cotton so far in advance. By using their skill and judgement to take a calculated risk in this way the merchants provide a service to the producers and to the spinners. Sadly, from the merchants' point of view, their market judgement will not always be right, and they will make losses as well as profits. However, it is safe to assume that established merchants must have been right more often than they have been wrong!

We have seen that probably the exporter will not want to sell at the same time as the spinner will want to buy. It is also likely that the exporter will not want to sell on the same terms as the spinner will want to buy, especially as regards payment. Most exporters want to be paid by an L/C against shipping documents at sight, or in some cases against documents of overland transport when the cotton is delivered from the gin. Some exporters may want to be paid before shipment against a warehouse receipt at the shipping port, or even before the cotton has been harvested. It is the job of the merchant to do his or her best to meet these requests as far as possible. It will not always be possible to meet the exporter's optimum requirements, but it is surprising how often creative solutions can be found by a merchant. On the other hand, spinners may want entirely different payment terms. They may be willing to open an L/C, but often with a term of 180 or even 360 days instead of at sight. In such cases the merchant must take the risk that the opening bank will remain creditworthy for the full period or must find another international bank to confirm the L/C. An international merchant will have close relations with many of the international banks for this purpose.

Receipt and confirmation of a valid L/C is only the start of the process of receiving payment. Many L/Cs are very demanding with regard to the documents the seller must furnish in order to obtain payment. They will usually demand bills of lading, a phytosanitary certificate, a certificate of origin, an invoice, and a packing or weight list. The seller will also have to furnish an insurance certificate (if the sale is on CIF terms) or a copy of the seller's advice of shipment to the buyer's insurance company if the sale is CF or FOB. The wording of all these documents must comply exactly with the requirements of the L/C, and the complete set of documents must be presented to the negotiating bank within the time stipulated in the L/C. They must also comply with the *International Chamber of Commerce Uniform Customs and Practice for Documentary Letters of Credit*. If even the smallest detail in the documents does not comply, the bank will advise the seller that there is a discrepancy in the documents, and payment will be refused until the opening bank has notified the negotiating bank that it accepts the discrepancy and authorizes payment. Obtaining this authorization can be a very long process and, at this point, the seller depends entirely on the goodwill of the buyer. Obtaining payment by L/C can require not only an expert shipping and documentary department, but also a good relationship with the buyer. This is an important part of the role of the merchant.

The accepted international currency of the cotton trade is the United States dollar. However some exporters may wish to be paid in their own currency, and some spinners may wish to buy in a currency other than the United States dollar. It is part of the role of the merchant to bridge this gap.

A more obvious gulf between the exporter and the ultimate buyer is a probable difference of language. Many international business relationships founder because communications break down. When speaking or writing in an unfamiliar language it is all too easy to convey a message that was not intended. Even when the two parties speak the same language it is quite common for misunderstandings to occur and for words to be taken as hostile when they were not intended to be so. When the two parties have no common language, such difficulties are magnified. It is part of the merchant's job to ensure that he or she can communicate clearly and effectively with both suppliers and with customers, either directly or through his or her branch offices or agents.

Not only is it likely that exporters and spinners will seldom want to buy and sell at the same time or on the same payment terms, it is also likely that their requirements as to transport will be different. Exporters will probably want to sell on ex gin or FOB terms, whereas spinners are likely to want CF, CIF, ex warehouse in their own country or delivered mill terms. In order to transport the cotton in the cheapest and most efficient way it is necessary to have close contacts with numerous shipping companies. Some of them may be cheap but not efficient. Others may be very efficient but have high freight rates. The merchant will be in constant touch with the major shipping companies in order to ensure that his or her cotton is transported across the world in the most effective possible way.

The global market is dominated by China. China is important because it accounts for about 40% of the world's cotton imports; consequently, world prices are very sensitive to the strength or weakness of demand in China. The Chinese market is not only large but very complicated and difficult to service efficiently. Nobody knows exactly how many cotton spinning mills there are in China but the number is thought to be over 10,000. Of course, many of these are too small to be able to import cotton effectively, but China consumes between 10 million and 11 million tons of cotton annually, and produces less than 7 million tons, so it is easy to understand that there are many large importing mills. They are spread over a huge area, so in order to service the Chinese market the merchant must have sub-offices or representatives all around the country. In recent months it has become more and more usual for merchants to 'consign' cotton to China. That is to say, they will ship unsold cotton to China, store it in port warehouses and finance it until they can find a buyer. Chinese spinners like to buy from consignment stocks because they can inspect the cotton before buying it. Furthermore they can take delivery on whatever exact date they agree with the merchant, so they do not have the uncertainty about arrival time that is inevitable when they buy cotton which is still in the country of origin. At the time of writing it is believed that international merchants have stocks of about 350,000 tons lying unsold at Chinese ports. Chinese spinners are growing used to buying in this way and they expect their major suppliers to be able to provide this service.

It should now be clear that, even if goodwill exists between the parties, the performance of an international cotton contract is a very complicated task. Problems may arise at any time. Vessels may be delayed, harvesting of a crop may be delayed, and transport of the cotton to the port may be disrupted by strikes, bad weather, or even war. The spinner may wish to delay shipment because of an unexpected downturn in demand for its yarn or cloth. If a shipment to China is delayed, for example, the merchant may be able to deliver substitute cotton on time to the spinner from stocks already lying in China, thus avoiding disruption to the spinner. If a spinner wishes to have a shipment delayed, the merchant may be able to allocate the cotton to another of his or her sale contracts, and thus still take delivery from the supplier on time. This kind of problem solving is an important part of the merchant's job.

It can also happen that, despite the best efforts of the seller, the spinner may be dissatisfied with a shipment. It may be that the spinner is unhappy with the quality or with the condition of the bale packing. If it is a matter of quality the spinner will need assurance that it is going to be financially compensated and that future shipments will be of the correct quality. If there is a problem with the condition of the bales this may be a matter for an insurance claim or for a claim on the seller, depending on the type of damage and the terms of the contract. It is much easier to solve this kind of problem in an amicable way by face-to-face discussion. As we have seen, the merchant will have a branch office or an agent who can visit the spinner to assess the nature of the problem and discuss it personally on the spot. If the problem is really serious the merchant may decide that an executive from the head office should visit the spinner.

Perhaps the most interesting part of the merchant's role is to bridge the many diverse cultures which exist in the world. Only by regular travel and telephone contact can mutual confidence and understanding be made to grow and prosper. If the two parties know each other personally and have developed some mutual understanding it becomes much easier to do business and to solve any problems that eventually may arise.

By far the most serious problem that can confront an exporter is a complete failure on the part of the buyer to perform the contract. Like any other business, spinning mills round the world vary in their financial strength and in their

attitude to contract performance. In recent months world cotton prices have been very stable, but this has been a very unusual period. The Cotlook A Index has moved within a range of less than 5 cents per lb. However, the average range over the past 15 seasons is over 18 cents per lb, and in 1994–1995 the range was over 46 cents per lb. Figure 4.1 illustrates the unusual stability of prices since January 2005.

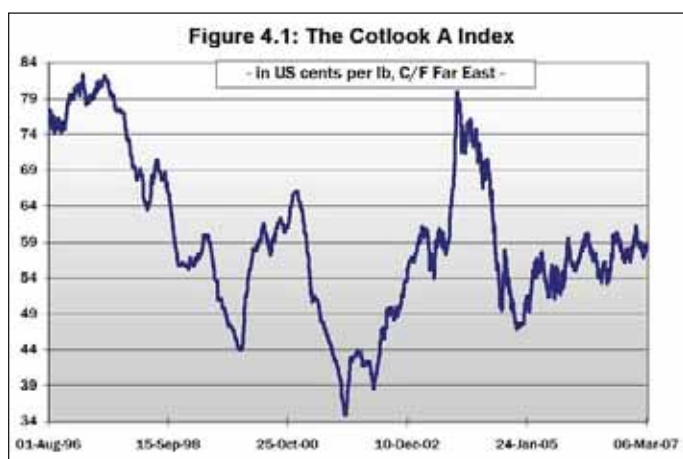

The more prices fluctuate, the greater the risk of non-performance. If the price has fallen sharply between the date of the contract and the contracted date of shipment, it may be that the spinner does not have the financial strength to open an L/C at the original contracted price.

Spinners might gamble that prices would increase when they buy cotton, and he/she be unwilling to face the loss when prices do the opposite to what they expect, so simply refuse to open their L/Cs. A more frequent occurrence than outright refusal to open the L/C is an assurance that it will be opened next week, then the following week, then next month, until it finally becomes clear to the seller that it will never come. In such a case the seller will be able eventually to obtain a financial award at arbitration, which in theory will compensate the seller for the loss. However, arbitration is a lengthy and laborious process which can take many months. When the award has been obtained it may take more time to persuade the spinner to comply with the award or to enforce it in the courts of the spinner's own country. Losses due to contract non-performance can be very substantial: a loss of 18 cents per lb (the average fluctuation in the A Index over the last 15 seasons) on sales of 2,500 tons amounts to about \$1 million.

Performance guarantee is probably the most important of all the merchant's roles. An established international merchant cannot afford to default on a contract with an exporter, even if the merchant's own customer has let him or her down. Although the cotton trade spans the globe, news within the cotton

community travels very fast and bad news travels fastest of all. Many of the major merchants have spent many decades building up their reputation, and their continued existence depends upon maintaining this reputation. To default on a contract would, and indeed should, ruin their reputation and eventually drive them out of business.

It would be foolish to maintain that there are no circumstances in which exporters should sell directly to spinners in another country, but they should be aware that there are many potential risks and a great deal of hard work involved in doing so. Because international merchants have a large turnover they are able to work for a small margin. Therefore a merchant can often pay to the exporter a price which is very close to the price that a spinner would pay. Indeed, it is not uncommon for a merchant who takes a bullish view of the market to pay a higher price to the exporter than is currently being paid by spinners.

Ease of travel and modern methods of electronic communication make it simpler today for exporters and spinners to be in contact with each other if they so wish. Nevertheless, merchants will certainly continue to provide their services to exporters and spinners for many decades to come.

The changing role of cotton merchants

The global cotton industry has never before experienced a period of change, development and evolution such as the current time. We are witnessing a rapid change in production practices and capacity through technology and newly developed regions, an increase in market information availability and efficiency, shifts in the manufacturing and processing advantage, and an evolution in the function and role of the cotton merchant.

How has the role and function of the traditional cotton merchant changed?

In the past, the cotton merchant profited by keeping ahead of the information curve. This practice is no longer what it used to be, thanks to the introduction and adoption of global information systems that allow market participants to access weather, supply and demand, and pricing information in real time. Market participants are now on a level playing field, in effect.

While merchants could become gloomy about how this information windfall is preventing them from staying in the cotton business, the reality is that by changing their focus and revolutionizing their business model they are able to create value by becoming integrated global cotton supply chain managers. The objective of the global cotton supply chain manager is to add value to each part of the process from production through to the mill door.

Managing the supply chain starts, as one would expect, with the production of raw cotton. By providing crop inputs such as fertilizer and funding to the cotton farmer, merchants can ensure the producer has the proper resources to achieve the highest possible yields and quality. Merchants combine this finance service with marketing facilities that assist the farmer in managing production and price risk. They position themselves as the preferred buyer for the farmer's crop. This provides substantial advantages in managing quality and delivery that eventually benefit the cotton mill buyer.

Once the crop is produced and ginned, having warehouse and logistics facilities under management ensures additional quality control and allows merchants to better service the mill customer with just-in-time delivery or specific quality requirements.

The warehouse business is often split between origin and destination. An example of destination warehousing is the consignment business in bonded areas in China; this service allows the Chinese mill customer to better manage cash-flow and quality by having a menu of actual cotton to choose from. This service is another innovation of the supply-chain minded cotton merchant.





While these concepts are already ‘in the market’, few cotton merchants have fully integrated each stage to ensure customer quality, price and service. For cotton merchants to remain relevant in today’s markets, they need to focus on being integrated supply chain managers.

What about the future of supply chain developments? How will the cotton merchant remain relevant in the future?

Technology in the cotton business includes additional improvements in genetics and crop production practices leading to increased yields and improved quality. There remains a significant difference between high and low global performers when it comes to yields. As technology is used more and is better implemented, average world yields will increase substantially as a result of a rapid improvement in the relatively low yielding producers.

As yields increase, the need for capital will increase also as increased crop inputs must accompany improved production practices. The cotton merchant has an expanded role to play in this area, which is a snug fit with the supply chain structure. Providing access to capital where it will be needed most in the coming years will require sophisticated financial engineering that will in turn require the cotton merchant to expand know-how beyond current convention.

Capital will also become a tool that the cotton merchant can use in better servicing the cotton consumer sector. This is not to suggest that cotton merchants will begin investing in cotton spinning mills but that by ‘partnering’ with their consuming customers they can provide additional liquidity for customers to use their own capital more efficiently and effectively. This side of the business is in the very early stages of development and has exciting prospects.

Technology also includes risk management skills. These have tangible value to both producers and consumers, and until now have not really gained traction, particularly on the consumer side. This will have to change in the future as macro conditions become more uncertain generally.

In the past, world class cotton merchants mostly subscribed to quality, service and price as the foundations of successful business. They must now include technology and capital contained in an integrated supply chain to remain relevant and useful to the industry into the future. Overlying this evolution and, more importantly, allowing merchants to achieve this strategy, are direct relationships. Direct relationships with producers and consumer are important, and in fact necessary for cotton merchants to successfully implement a supply chain strategy.

Direct relationships allow the merchant to better understand and manage the needs of the producer and consumer and more importantly allow them to add value to a client’s business. To be and remain relevant and viable in the long term, merchants must be committed to the integrated cotton supply chain business and direct relationships with producers and consumers.

Cotton exports and Internet trading

The Seam (www.theseam.com) began in 2000 as a completely Internet-based online marketplace for cotton. Founded by a consortium of companies involved in cotton, manufacturing and agriculture, the vision for the firm was to become a web-based hub for a variety of business-to-business transactions and services. That vision has been expanded to now include other commodities and products.

One facet of that vision was to make online cotton trading available globally. A long history of trading United States cotton electronically had already demonstrated that buyers and sellers recognized the value of the efficiencies gained through technology. The Seam launched its International Marketplace in 2002 with five growths: Australia, Brazil, Commonwealth of Independent States (CIS), West Africa and United States. The International Marketplace offers a platform for merchants to post offers or bids to the global trading community. It provides an end-to-end solution for generating, managing and fulfilling an ICA contract. In addition to expanding the global reach of merchants, instantaneous, transparent price discovery is available. The system also manages counterparty screening and credit.

The International Marketplace has continued to grow and extend its service offerings to other market participants. Growths from Greece, Paraguay, Argentina, Pakistan and the United Republic of Tanzania have been added to the platform. Other world growths will be added soon. More recently, the system was opened to a limited number of origin sellers in Brazil through online auctions.

Cotton exports and Internet auctions: a case study

Auctions are a time-tested manner of selling cotton from origin to the trade. For decades, cotton producers in Mali, Côte d'Ivoire, Sudan, Argentina, Pakistan and others have auctioned their cotton to merchants. Traditionally, auctions have been conducted via sealed bid, with buyers using a local representative to deliver a single submission to the seller by a specific deadline. While this has the advantage of allowing for the very occasional possibility that one buyer may bid significantly higher than the others, it does not match the drama of an auction room, with multiple bidders sparring to be the successful buyer.

Internet auctions

In 2005, The Seam launched a product known as cAuctions® for Brazilian farmers. cAuctions capitalized on the fact that in a sellers' market, buyers will aggressively compete to purchase and therefore control exportable supplies of cotton. Auctions create a level of competition that does not exist in conventional bilateral negotiations. One of the primary factors introduced by the auction process is instantaneous price discovery. This, combined with the velocity of activity and the commitment of auction participants, means that the auction process produces prices above what the seller can expect using other means. A well-facilitated auction should capture the maximum market value available to the seller. These elements are essential to any auction process, whether online or in a physical location. However, the Internet has introduced a new point of access for all participants in the market. Sellers can utilize its connectivity and interaction to consolidate liquidity and intensify the auction effect to their benefit.

In this scenario, Brazilian producers announced that their cotton would be tendered for auction on a specific date and time. To give buyers an incentive to participate, producers offered multiple lots simultaneously in the same auction event. There was no requirement for any participating producer or bidder to be in the same physical location.

Facilitating the auction market

Prior to bidding, the potential buyers were allowed to review each offer during an announced preview period. Offers were for forward shipment and specified all necessary criteria, including: origin, volume, grade, staple, micronaire, strength, shipment, Incoterms, payment details, special clauses, and rules and arbitration. The offer appeared in the form of a provisional final contract to ensure that the buyer knew the terms and quality prior to bidding. Sellers established reserve (floor) prices. If the highest bid was above the reserve, the offer was booked to the highest bidder. If the reserve price was not met during the auction, the bids were still valid for a period of time after the auction. This gave the seller the option of accepting the highest bid (or several of the highest bids) even if the reserve had not been met.

The Seam provided a mechanism for unattended bidding called Bid Manager (see figure 4.2). Bid Manager allowed buyers, in the preview period before the start of the auction, to enter a starting bid and a maximum bid. This allowed participants in any time zone to participate in the auction, thus further increasing liquidity.

Figure 4.2: The Seam's Bid Manager allows buyers to participate in auctions unattended, by establishing their price parameters and then letting the system bid for them

The screenshot shows the 'Bid Manager' interface with the following details:

- General:** Offer 15117, Origin BR, Growth Mato Grosso, Quantity 1350 mt, Description 31-4 & better, Staple 1-3/32"
- Fixed:** Bid Price: \$2.00 (xx.xx usc/lb), High bid: \$2.00, Reserve: Not 1, Maximum Bid Price: \$2.00 (xx.xx usc/lb)
- Basis:** Bid Price: (xx.xx points), Maximum Bid Price: (xx.xx points)
- On/Off:** Off, NYF Month: December 2005
- Bid Types:** Domestic / Export - Buyer's Option, Quantity: 1350 (mt)

A note at the bottom right states: "Bidders may place both Fixed and Basis bids. Buyer's final position will not exceed one bid per lot."

Figure 4.3: Buyers can view auction activity and respond to price changes

The screenshot shows the 'International Trading' interface with a table of offers. The table has the following columns: Status, Offer, Origin, Growth, Quantity, My Fixed, My Basis, Expiry, High Fixed, High Basis, Description, Staple, Micronaire, Strength, Shipment, and Terms.

Status	Offer	Origin	Growth	Quantity	My Fixed	My Basis	Expiry	High Fixed	High Basis	Description	Staple	Micronaire	Strength	Shipment	Terms
Expired	15454	BR	Mato Grosso (do sul) 2000 mt		\$1.25			\$1.25		21-2 & better	1*	3.5 to 4.9		7/05	Paranagua FOB
Open	15482	BR	Mato Grosso (do sul) 2000 mt		\$1.25		11:09 CST	\$1.25		21-2 & better	1*	3.5 to 4.9		7/05	Paranagua FOB
Expired	15466	BR	Mato Grosso (do sul) 2000 mt			-300/25			-100/25	21-2 & better	1*	3.5 to 4.9		7/05	Paranagua FOB
Open	15477	BR	Mato Grosso (do sul) 2000 mt							21-2 & better	1*	3.5 to 4.9		7/05	Paranagua FOB
Open	15476	BR	Mato Grosso (do sul) 2000 mt							21-2 & better	1*	3.5 to 4.9		7/05	Paranagua FOB

The interface also includes a navigation bar with 'Offers', 'offers', 'bids', and 'manage farmers' buttons, and a footer with 'Page 1 of 1'.

Once the auction started, the bidders could increase their bids but not lower them. If bidding was still continuing at the end of the auction, then the auction automatically extended to make sure that the final price was the best the market would pay. Once the auction was over, the sellers had a defined period of time to confirm the bids they had received – with electronic contracts being automatically generated upon confirmation

Strategies and effects

A system such as the one provided by The Seam suits a market where the sellers are the owner of the commodity and their only interest is in getting the best possible price. Where an agent is acting on behalf of a seller, then that agent is simply interested in getting a sale and so may prefer to conduct bilateral negotiations. Internet auctions have proved an effective way to conduct simultaneous, transparent, multilateral negotiations. In the Brazilian case, the basis for their cotton was raised significantly. The initial auction increased producer prices by approximately 5%. Successive auctions moved more than 40,000 tons of cotton to market.

Buyers do not universally embrace electronic auctions just because they promote transparent competition. It is therefore critical that sellers commit a certain volume to the market, and that buyers know that this is the only channel through which this cotton can be purchased. Facilitators and sellers must stay the course to ensure that, once the auction method has been established, buyers are required to participate. Anything less than compulsory participation will diminish the benefits of the auction.

In the Brazilian case, the cotton was offered with all specifications noted on the offer. Offers tended to be for forward shipment, often on cotton that had not yet been ginned and classed. However, as electronic instrument testing grows in popularity around the world, it would be desirable for sellers to be able to upload spot offers and sell with HVI data final.

The future

E-commerce in cotton and other commodities is a permanent feature of the market. However, as with all production and processing activities, enhancements to technology and business practices are inevitable. One probable enhancement will be the ability to provide certified HVI data for electronic auctioning, so that the buyer knows the description of each bale being offered. This is already a reality in the United States, and has been for many years, through The Seam's online cotton market. As other cotton producing areas become HVI enabled, the market, especially spinning mills, will demand the data at the time of sale. Another advantage is that the seller does not have to deal with any claims for lower than contracted quality. The certified data is final, and thus cannot be disputed.

Electronic data may also present opportunities for electronic documentation. If the contract, all the specifications, and the shipment details are already confirmed electronically, then the first step for electronic documents to be presented has been completed. If export documents, such as the bill of lading, phytosanitary certificate, invoice and certificate of origin could also be generated electronically and certified as original, this package could be sent electronically to the buyer, thus speeding up payment time for the origin seller.

Many of these advantages rely upon different segments of the trade and government creating common technology that can communicate easily.

Conclusion

Internet auctions provide sellers and buyers with the beneficial elements of conventional auctions, plus additional benefits afforded only by the Internet. Internet platforms such as cAuctions by The Seam help sellers to overcome time and space challenges to maximize the number of participants in an auction event. Provided the seller is committed to the method and the facilitator can assemble adequate liquidity, auctions can produce results far superior to conventional bilateral negotiations. For more information, see www.theseam.com.

Cotton futures and options – ICE Futures U.S.⁹

The trading of agricultural commodities represents one of civilization's oldest commercial activities. Crop commodities, such as cotton, have been in use for thousands of years. Basic commodities with universal value in different cultures could be described as the first international currencies of exchange. With such a long history as a basis of commerce, it is easy to understand how the marketplace value of a commodity could play a major role in the rise and fall of empires.

The shape and scope of commodity trading has evolved since the early trading routes were established, but the role of commodity trading remains a

⁹ Formerly the New York Board of Trade®, NYBOT®, NYCE®, Cotton No. 2, United States Dollar Index®, and USDx®, are registered trademarks or service marks of the Board of Trade of the City of New York, Inc.

fundamental economic component in world economic development. The price fluctuations of a basic commodity can still shock the economy of a country or an entire region. The price of the latest cotton crop matters a great deal. The central importance of commodity pricing gave rise to the commodity exchanges and their principal pricing tools – futures and options contracts.

Futures markets exist *because of price risk in the cash market* for the underlying industry. No price risk means there is no role for a futures market – a fact that is crucial to any understanding of the purpose and function of the futures markets. Cotton futures represent cotton that will become available at some point in the future, based on standard contracts to deliver or accept a predetermined quantity and quality of cotton at one of the contract specified delivery ports. The only points to determine when trading a futures contract are the delivery period (the month listed for the contract) and the price. The delivery period is chosen from a preset list of calendar months or contract months. The price is negotiated openly in the marketplace.

For well over a century, cotton industry representatives have joined traders and investors in the ICE Futures U.S. (formerly “the New York Board of Trade (NYBOT)”) futures and options markets to engage in price discovery, price risk transfer and price dissemination for this internationally traded commodity. Each day, people from around the world look to the ICE markets for a benchmark price in cotton.

To support a futures market, a cash market must have certain characteristics: In addition to sufficient price volatility and continuous price risk exposure affecting all levels of the marketing chain, it should have enough market participants with competing price goals (buyers and sellers) and a quantifiable underlying basic commodity with grades of common characteristics that can be standardized.

The futures marketplace is an organized marketplace that provides and operates the facilities for trading; establishes, monitors and enforces the rules for trading; and keeps and disseminates trading data.

The exchange does not set the price. It does not even participate in cotton price determination. The basic price functions supported by the exchange marketplace are price discovery, price risk transfer, price dissemination, price quality and arbitration. The exchange maintains a transparent, free market setting for the trading of futures and options, which helps the underlying industry find a fair market price (*price discovery*) for the product and allows the *transfer of price risk* associated with cash price volatility. As price discovery takes place, the exchange provides *price dissemination* worldwide. Continuous availability of pricing information contributes to wider market participation and to the *quality of the price*. (More buyers and sellers in the marketplace means better pricing opportunities.) Greater participation means that price discovery reflects the fundamental conditions of the commodity market as a whole (particularly in relation to the basics of supply and demand). To ensure the accuracy and efficiency of the trading process, the exchange also resolves disputes through *arbitration*.

Two markets

To understand the cotton futures market, a distinction must be made between physical (cash) cotton and cotton futures.

In the cotton cash market, participants buy and sell physical cotton of different grades and quality that will be delivered immediately on a specified date. The cash transaction therefore involves the transfer of ownership of a specific lot of a particular grade of physical cotton. Cash market contracts for later delivery of

cotton, called forward contracts, should not be confused with futures contracts. *The cash price for the cotton is the current local price for the specific product to be transferred.*

In the cotton futures market, participants buy and sell a price for a standard grade of cotton. The futures transaction centres around trading a futures contract based on physical cotton (or its cash equivalent) at a price determined in an open auction – the futures market. *The futures price is the price one expects to pay, or receive, for cotton at some future date.*

The futures contract is a standardized legal commitment to deliver or receive a specific quantity and grade of a commodity or its cash equivalent on a specified date and a specified delivery point. The standardization of the contract allows market participants to focus on the price and the choice of contract month.

Traders in the cotton futures market are primarily interested in risk management (hedging) or speculation, rather than the physical exchange of actual cotton. Although delivery of physical cotton can take place under the terms of the futures contract, few contracts actually lead to delivery. Instead, purchases of contracts are usually matched by offsetting sales and vice versa before the contract expires, and no physical delivery takes place.

In addition to its pricing functions, the cotton futures market helps to support standards of quality and grade that can be applied throughout the industry.

Price risk

Since the futures contract is standardized in terms of the quantity and quality of the commodity, the futures price represents an average price for an average range of qualities. The price for each individual grade and quality of cotton may be higher or lower than the futures price. Historically, the futures price and the cash price tend to move closer together as the futures contract delivery date draws near. While such convergence does occur in an efficient market, prices for physical cotton often fluctuate quite independently from the futures market. The physical premium or discount (the differential) represents the value the market attaches to a specific cotton compared to the futures market (plus or minus). This price differential, or basis, can reflect local physical market conditions, as well as the cotton quality and grade.

Price risk has two components:

- *The underlying price risk.* Prices for cotton futures rise and fall and reflect the overall market conditions.
- *The differential or basis risk.* The difference in price between physical and futures for a particular shipment of cotton (the basis) increases or decreases compared to prices in the futures market.

Futures markets can be used to moderate exposure to price risk because they represent the state of supply and demand for an average grade of widely available cotton. They cannot be used to moderate the differential or basis risk, which attaches entirely to a particular bale, shipment, grade or quality of cotton. Underlying price risk is almost always greater than basis risk, so the risk reduction capability of the futures market is an important management tool. Basis risk can sometimes be very high and should never be ignored, however. It is useful to examine historical differential pricing to identify periods and sources of increased differential risk, such as seasonal factors.

Physical cotton prices are often largely determined by applying a differential to prices in the futures market; that is, the combination of the differential and the price of the selected futures position gives the price for the physical cotton.

Price quality

Liquidity is critical in determining the success of a futures market. A futures market that has enough participants with competing price goals (buyers and sellers) can produce a turnover high enough to permit buying and selling of contracts at a moment's notice without direct price distortion. Large transaction volumes provide trading flexibility (liquidity) and enable traders to pick the most appropriate contract month, corresponding to their physical delivery commitments, and to hedge the price risks inherent in that physical transaction. More bids to buy and offers to sell in the market at any given time increase pricing efficiency for the participants. A mature marketplace such as the ICE cotton market provides the necessary deep liquidity on a global scale.

Speculators and hedgers competing for price helps the futures and cash prices to move in the same direction over time, and creates price convergence near the contract expiration. The futures market, however, may not always completely reflect cash market conditions, especially over a very short term period when large volumes may be traded for purely speculative reasons. The volume of futures trading (and the underlying physical quantity of cotton represented) may easily exceed total production of cotton. The fundamental conditions of supply and demand in the marketplace and the execution of related hedging strategies by segments of the cotton industry generally correct any short-term variations that may come from increased speculative activity.

It is important for cotton hedgers to be aware of the activity of investors (speculators) in the market. For that reason, the futures industry regularly examines and publishes the ratio of speculative and hedging activity in the market. Speculators are absolutely necessary to the efficient function of a futures market. Speculative activity directly improves liquidity and serves hedgers' long-term interests.

Periods of extreme price volatility can also affect price efficiency. If everyone is primarily trying to sell, or if most traders want to buy at any given moment in the market, the price moves quickly and it may be more difficult to achieve price goals. The presence of speculators with short-term goals and strategies (often less than a day) becomes even more important during the periods of increased volatility, because they may enter and exit the market quickly on either the buy or sell side and provide more pricing points during the trading day.

Options on futures provide speculators with yet another opportunity as well as offering risk managers greater flexibility in planning and executing hedging strategies. In recent years options have become more and more important to the cotton industry and on some business days actually exceed futures in trading volume.

Leverage

Cotton futures contracts are leverage instruments, meaning that a trader does not pay the full market price for each contract. Instead, futures traders pay a small portion of the contract's total value (usually less than 10%) in the form of margin, a good faith deposit to ensure contract performance. An ICE Cotton No. 2 contract at 50 cents per pound, would be worth \$25,000 (each contract is for 50,000 pounds of cotton). The margin requirement for each contract might be \$1,200 for a speculator or \$900 for a hedger. For ten contracts, a speculator might post \$12,000 in margin, representing \$250,000 worth of contracts. If the market moves against the trader's position by 1 cent per pound on any given day, it would require payment of a total of \$5,000 in variation margin. If the

market had moved in a positive direction, of course, the trader will have the same amount in profit from the day's activity. Margin calls can be a regular feature of holding a futures position and must be factored into any trading plan.

The purchase of options does not require the posting of margin, another part of their appeal to traders.

Organization of a futures market

Clearing house

The clearing house conducts all futures business, including the assignment of delivery notices of physicals under the terms of the futures contract. The ICE Clear U.S. is the designated clearing house for the ICE Futures U.S. Inc. NYCC was originally organized in 1915 as the New York Cotton Exchange Clearing Association and later became the Commodity Clearing Corporation. Although a NYBOT subsidiary, NYCC has its own separate membership, board of directors, elected officers and operating staff. It provides clearing services and financial stability for its clearing members.

The development of the clearing corporation adds a crucial advantage to futures trading. The clearing house removes counterparty credit risks and performs two major functions: reconciliation and clearing of all futures and options transactions made on the exchange; and assuring the financial integrity of such transactions. Through its system of financial safeguards and transaction guarantees, NYCC protects the interests of the trading public, members of the exchange and its clearing members.

NYCC assures contract performance through stringent financial requirements and NYCC member position limits.

Trading

Floor trading of futures contracts is permitted only between exchange members or those who have a permit to trade on the exchange. In the traditional not-for-profit membership organization model of the exchange, members must own or lease a membership (a seat) on the exchange; they may sell this membership at any time to other firms. The memberships are owned by a variety of entities from large firms to local traders.

Many exchanges have become publicly owned, for-profit companies: NYBOT was acquired by IntercontinentalExchange (NYSE:ICE) in January 2007 and is now part of a public company. 'Memberships' have been changed to represent floor trading rights only; this still restricts who can actually trade on the floor of the exchange in traditional open outcry. However, any would-be trader can be given direct access to the electronic trading platform if he is so permissioned by the electronic member who carries his trading account. This is one of the key advantages of an open electronic trading platform. The firms and individuals that trade represent many interests both speculative and hedging. Local traders (individuals who trade for their own accounts) have long represented a significant portion of the daily volume on an exchange and thus an important source of liquidity.

Buy and sell positions for the same contract month offset each other and are built up on a daily basis. The members use the clearing house to match offsetting positions and clear them from the records of the brokers who handled them each day. Trades are matched and cleared electronically throughout the day. The clearing house then takes the place of the buying or selling member; it performs the role of seller to all buyers and that of buyer to all sellers. Direct settlements of accounts are automatically possible at the close of each trading day.

The clearing house checks, settles and reports each day's business and guarantees the fulfilment of each contract. This is assured through the payment of margins and the collection of all outstanding obligations from members within 24 hours. Each account is 'marked-to-market' at the end of the trading day, with payments moving in or out depending on the movement of that day's market price. Clearing members pay into a permanent guarantee fund, enabling the clearing house to assume financial responsibility if a member defaults.

Supervision and regulation

The United States Commodity Futures Trading Commission (CFTC) is charged with the supervision of trading in commodity futures. CFTC reports direct to the United States Congress and it is charged with protecting the trading public from abuses by the futures industry, such as manipulation of the market or deceptive practices that might prevent the market from correctly reflecting supply and demand factors. It also seeks to ensure that exchange members are financially viable. The NYBOT exchange bylaws, rules and regulations are statutory and have the force of law. The provisions of the CFTC Act require that every intermediary who deals with the members of the public investing in futures must be registered with the National Futures Association, a self-regulatory body created by the Act. NYBOT, through the use of electronic surveillance and professional personnel, actively monitors trading activity and enforces trading rules and regulations.

The former NYBOT and now ICE Futures U.S. cotton marketplace

Cotton forward contracts

The development of the steam ship changed the way cotton was bought and sold. When information could travel faster on a steamship ahead of the actual goods that followed on a sailing ship, the process of negotiating cotton prices became more complex and speculative. Forward contracts on expected delivery of cotton still on the docks on the other side of the Atlantic began to replace immediate transactions of cotton arriving in port.

Movement of market information instead of the physical arrival of the commodity in port became a dominant factor in pricing cotton. Moreover, the successful installation of the transatlantic cable and the use of the telegraph made key market information instantaneously available on both sides of the Atlantic (New York and Liverpool), and intensified trade of forward contracts on cotton. As the practice of forward pricing increased and market information played a greater role, the need to bring some order to this process necessarily led to the creation of the cotton futures exchange – a place where market information, competitive buying and selling, and the shifting of risk exposure could take place in an organized manner.

Futures trading started on the American side of the Atlantic in 1870 in New York because cotton traders could no longer agree on who should assume the price risk inherent in a forward contract during the six weeks time it took for a shipment to make its way across the Atlantic.

On 20 July 1870, 106 cotton merchants and brokers signed an agreement to support plans for an organized marketplace where some sense of order could be brought to the business of buying, selling and (most important) pricing of cotton. The result – the New York Cotton Exchange (NYCE) – officially opened for business on 10 September 1870. NYCE quickly grew into a highly visible, liquid futures marketplace. The addition of options on cotton futures in 1984 affirmed NYCE's central role. In 1998, NYCE merged with the Coffee, Sugar

and Cocoa Exchange, Inc (CSCE) to become the New York Board of Trade® (NYBOT®). As a result of the tragic events of 11 September 2001, NYBOT's location at 4 World Trade Center in downtown Manhattan was lost, and NYBOT united with the New York Mercantile Exchange (NYMEX) and the Commodities Exchange (COMEX) in a new Manhattan building. NYCE (NYBOT) holds the distinction of being the oldest commodity exchange in New York. It is also the longest-running cotton exchange in terms of continuous operation in the world.

Price risk has always been a central characteristic of the cotton industry. The need for transparent and effective price discovery and price risk transfer has made cotton futures and options critical risk management tools for all those who grow, trade, and mill cotton as well as to those involved in the manufacturing and selling of cotton goods, and the NYBOT remains a premier marketplace for cotton futures and options and the central pricing mechanism for the cotton industry internationally.

Futures and options contracts

Futures contracts, descended from forward contracts, have remained basically unchanged in form and function since the founding of the first futures exchanges. Forward contracts are cash market transactions that establish the terms for the actual ownership transfer of the physical cotton at a specific delivery date. The terms of the contract are unique to the parties involved. Forward contracts became possible as information transfer accelerated in speed. A futures contract, however, differs from a forward contract primarily in that it is standardized and, while it has a delivery component, it does not exist primarily to facilitate physical delivery.

A futures contract is a standardized agreement to purchase or sell a fixed quantity of a commodity at a predetermined price, with settlement to take place at a future date. The only negotiable element of the contract is the price. The trading of cotton futures, therefore, involves pricing cotton. Unlike forward contracts, delivery of futures contracts seldom takes place; the difference between the agreed and spot price at the time of contract expiration is typically settled through a cash transaction.

An option on a futures contract grants the right, but not the obligation, to buy (call options) or sell (put options) a futures contract on the commodity at a prearranged price (the 'strike price'). For this contract, the buyer or seller of the option has to pay a price at the time of contracting which is called the 'premium'. In effect, an option contract provides a kind of price insurance.

Although the institutions and the governing rules and regulations behind the contracts have evolved considerably over time, the concepts behind futures and options contracts and the purposes they serve remain largely unchanged. Futures markets are created to serve cash market needs and therefore seek to reflect cash market conditions. The exchange's capability to adapt contracts and trading procedures in response to changing industry practices and conditions accounts for its long-term survival and its continuing ability to serve the underlying industry.

Trading ICE Cotton No. 2 futures and options contracts

In spite of all of the changes in the cash market, the cotton futures market today still provides the same primary pricing functions as ever: price discovery, risk transfer and price dissemination. The world prices its cotton at a premium or discount to the Cotton No. 2 futures contract traded in New York. The unique characteristics of cotton as a plant are revealed in the complex grading standards of the cotton futures contract. In 1887, NYCE implemented the

certificate system. Under the system, a certificate stipulating the grades of cotton became good for delivery, passing from hand to hand like a stock certificate.

This became the standard for recording and guaranteeing the quality of each specific bale of cotton, a measure necessary to ensure the validity of the futures contract as a benchmark for pricing. USDA is the source of grading cotton for certification in the United States. The certificate functions as a kind of 'currency' that facilitates the trading of cotton futures.

The Cotton No. 2 futures contract is for 50,000 pounds (about 100 bales) of certain minimum standards of basis grade and staple length – strict low middling with a staple length of 1-2/32". Contracts are listed for March, May, July, October and December plus one of more of the 23 succeeding months. No origin is specified. The delivery points listed are: Galveston, Texas; Houston, Texas; New Orleans, Louisiana; Memphis, Tennessee; and Greenville/Spartanburg, South Carolina.

The price is quoted in cents and hundredths of a cent per pound. Daily price limits are applied of 3 cents above or below the previous day's settlement price. However, if any contract month settles at or above \$1.10 per pound, all contract months will trade with 4 cent price limits. Should no month settle above \$1.10 per pound, price limits stay (or revert) to 3 cents per pound. In the spot month (contract nearest expiration) there is no limit on or after the first notice day.

Floor trading hours are 10:30 a.m. to 2:15 p.m. Eastern Time. Electronic trading hours are 1:30 a.m. to 3:15 p.m.

The primary cotton classing components are colour, length, micronaire and strength. Micronaire is a reading of the coarseness of the fibre measured by its resistance to air passage. Strength is quoted in gram per tex (g/tex). Regarding colour, the contract permits delivery of only 'white' grades of 'good middling to low middling' and light spotted grades of 'good middling to middling'. The basic fibre length is 1-2/32" with a minimum of 1-1/32" at commercial discount and a maximum of 1-3/32" at a premium. Any longer staple does not carry a higher premium.

Industry standards and practices have periodically led to specification changes. The minimum grade of cotton deliverable against the contract was raised to low middling from good ordinary in 1920. A contract permitting southern delivery was introduced in 1929. In 1939 the basis of the cotton contract was changed from 7/8" to 15/16" and raised again in 1953 to 1". Trading in the Cotton No. 2 contract with a 1-1/16" basis was introduced in 1967. In 1974, the basis grade was changed from middling 1-1/16" to strict low middling 1 1/16".

In recent years the exchange has adjusted the contract specifications to reflect industry practices. Beginning with the May 2003 Cotton No. 2 contract it:

- ❑ Increased the minimum strength requirement to 25 g/tex (from the previous minimum of 22);
- ❑ Allows for price differentials should USDA commence quoting price differentials for cotton with a micronaire level of 4.8 or 4.9 (currently, micronaire readings of 3.5–4.9 are allowed with no premiums or discounts);
- ❑ Established a new 'age of cotton' discount applied to cotton delivered on and after 1 January of the second calendar year following the cotton's year of growth.

The stability and continuity of the futures market function is based on the standardization of the contracts to reflect cash market conditions and practices.

ICE continuously monitors the performance of its markets and the changing cash market conditions. Adjustments have been and will continue to be made to the contract as cash market conditions, crop characteristics and industry practices demand. The exchange's Cotton Contract Committee is charged with maintaining the integrity of the contract. Proposals for new contracts are also considered and evaluated for potential introduction to the market.

The evolution of the cotton certificate system illustrates how the exchange can change its procedures and practices while maintaining the essential concepts of its primary functions. Today the certificate system still serves its original purpose, but the development of the Electronic Warehouse Receipt (EWR) system has allowed the assignment of ownership of a bale of cotton to move from a cumbersome manual exchange of paper to a completely electronic transfer and record of the transaction. With ever-increasing globalization, the ability to transfer ownership instantaneously via electronic means ranks with the development of the steam ship and the transatlantic cable as a change in the movement of critical market information.

The cotton industry uses the Cotton No. 2 futures contract as its primary tool to hedge the purchase or sale price of cotton. Hedging is possible because the cotton futures and the cash market have a strong relationship and generally move in tandem over time. In cotton, the basis has particular importance because of the many pricing variables that affect the global marketplace. To establish a successful hedge, the industry user in cotton (as in other agricultural commodities) must calculate and examine the historical basis for the product trading in the local cash market. This basis risk cannot be transferred to the futures market.

Since the abolition of the gold standard in 1973, all cotton futures contracts, with the exception of India, have been traded in United States dollars. Hedging or speculation in cotton futures in any other currency, therefore, involves unpredictable exchange rates and adds one more element of pricing uncertainty. Currency risk therefore becomes a factor in calculating basis risk. Comparing the movement of the United States Dollar Index® (USDIX® futures and options are traded in the ICE financial markets) and the Cotton No. 2 nearby futures contract illustrates how the rise and fall of the United States dollar affects the price of cotton. When the dollar falls, cotton has often risen in price.

For cotton in the United States, knowledge of basis must be coupled with an understanding of the changeable logistics of government support programmes. A look at the history of cotton futures trading in New York reveals the impact of government programmes. Between 1950 and the early 1970s, NYCE exhibited an extraordinarily low trading volume. This was a direct result of the United States Government's policy of maintaining large cotton stocks: the Commodity Credit Corporation (CCC) bought and sold most of the United States cotton, thus eliminating the need for cotton hedging by merchants. For example, in 1966, CCC accounted for 73% of cotton carryover. The Government's interference in the cotton market was so severe that it almost led to the demise of the exchange. In 1966, NYCE traded only 730 contracts – a daily average of 3 contracts.

The Farm Security and Rural Investment Act of 2002 and its subsequent changes presented cotton hedgers with new challenges and opportunities. Cotton hedgers today rely heavily on the flexibility of options on Cotton No. 2 futures to reduce risk and capture the benefits of favourable price moves. The increased volume of cotton options in recent years has demonstrated their growing importance to risk managers.

Regular options are available on the March, May, July, October and December Cotton No. 2 futures contracts. The nearest 10 delivery months are listed for trading. For example, in August 2006, options on the October 2006, December 2006, March 2007, May 2007, July 2007, October 2007, December 2007, March 2008, May 2008 and July 2008 contracts were available for trading.

The successful cotton hedger can utilize a variable mix of futures, options on futures and forward contracts. The cotton futures and options markets provide a number of possible hedging and investment strategies and opportunities. In order to successfully plan and implement a hedging strategy, the risk manager must compile a marketing plan that includes a reliable history of all input costs, risk tolerance, cash flow, seasonal factors, price/profit goals and historical basis. Once the hedging position has been put in place, it should be monitored and adjusted as market conditions warrant.

The fundamentals of cotton supply and demand

Unlike other basic commodities that are more land and climate specific, such as cocoa or coffee, cotton can grow nearly anywhere that has the requisite 200 frost-free days and basic water supply. While cotton is relatively easy to grow, it varies widely in terms of grade. This means that the quality of cotton grown and the availability and desirability of each grade become major pricing factors on the demand side. Cotton grading from coarse to premium is a critical economic issue for the end-user. Coarse cotton can be used for such things as denim, whereas premium cotton is necessary to make soft sheets and shirts. The market continually shifts, and favours different growths in different countries depending on growing conditions and the type of cotton suitable for the region.

The hardy nature of the cotton plant has made it a common cash crop for many countries in both the developed and developing world. In some developing nations, over half the gross domestic product (GDP) is represented by cotton production. Like sugar, virtually every country in the world uses cotton in some form. The ease with which cotton can be grown, the seemingly endless variety of potential goods that utilize cotton, and the commodity's vulnerability to unforeseen natural and man-made events raise the economic stakes for cotton and ensure its enduring place in the world economy. Cotton's primary economic position and the impact of cotton pricing help to explain the significant role of a cotton futures exchange.

Raw cotton fibre has certain qualitative and quantitative characteristics that can be standardized, making it a commodity well suited to a futures market. The success of a futures market also should involve a broad range of participants with competing price goals and be subject to uncontrollable and unforeseen events, such as drought or flood, which will create price shocks and thereby expose all levels of the industry to price risk. Cotton fulfils all these criteria, but it also presents some unique characteristics. The price history of cotton tells the story of the ever-present price risk.

The ICE cotton futures and options markets provide risk managers with a variety of strategic choices in developing an effective hedging strategy. The successful risk manager will carefully assess business goals, market conditions and available hedging tools. Each contract and capability offers different advantages to the risk manager.

Futures hedging provides the security of locking in a price. While margin must be posted to maintain an open futures position, futures hedging does allow hedgers to set specific price goals. Margin represents only a small percentage of the full value of a contract and stands as a 'good faith' deposit to guarantee that the hedger will be able to meet obligations on a daily basis if the market moves

unfavourably. Hedgers may be required to add more margin to keep the account at a minimum level in the case of adverse price moves. The hedger also has daily access to any gains realized in a favourable market.

Options on futures hedging allow the establishment of a price ceiling or floor while still allowing hedgers to take advantage of favourable cash market moves. Buyers of options must pay the full premium upon purchase of the option. Loss is limited to the full amount of the premium. Futures therefore offer greater certainty, while options provide more flexibility. The exchange supports other hedging capabilities as well.

Other hedging transactions

Exchange of futures for physicals

Some hedgers will choose to enter into an exchange of futures for physicals (EFP) arrangement to help limit basis risk. An EFP is a standardized way for a buyer and seller of cotton to combine the cash market transaction with the futures hedge. The agreement allows the two parties to base the cash price on the futures price plus or minus a differential. The net cash price is set in the futures market through the use of futures contracts. EFPs allow the buyer and seller to set the price independently of each other.

First the buyer and seller agree to use a specific futures contract price as the benchmark price plus or minus an agreed differential. Second, the buyer and seller establish a futures position and thereby effectively set the price for the deal. Third, at an agreed date, the buyer and seller register an EFP on the exchange. The brokers for the buyer and seller at that point close out their clients' positions at the same current market price, which becomes the invoice price for physical delivery (plus or minus the differential). Finally, the cotton is delivered at that price.

Exchange for swaps

The exchange for swaps (EFS) allows market users to exchange futures contracts for qualifying swap agreements. A swap is a contractual agreement in which two parties agree to make periodic payments to each other. Swap contracts are customized for the parties involved. In a commodity swap, one party pays a floating price for a commodity and the other pays a fixed price for that commodity. The physical commodity is not actually exchanged. Payment flows are limited to the difference between the floating price and the fixed price. Basically one party is paying an agreed-upon rate for the second party to assume a certain level of price risk.

Options on spreads

Options on futures spreads (OFS) contracts are a relatively new type of option contract. Since different futures contracts trade at different prices (the outer months often reflecting 'carrying charges'), market participants may wish to hold 'spread' positions, namely buy/sell contracts in two different contract months. Where a regular option contract gives the buyer the right, but not the obligation, to establish a futures position at a pre-determined price level, an OFS gives the buyer the right, but not the obligation, to establish a spread position at a predetermined spread price between the two futures contract months.

An OFS call option contract would give the buyer the right to establish a spread position of long on the first futures contract and short on the second futures contract. The strike price of the call option is the difference between the prices of the two futures contracts. Similarly, an OFS put option would give the buyer

the right to establish a spread position of short on the first futures contract and long on the second futures contract. As with the call option, the strike price of the put option is the difference between the prices of the two futures contracts.

ICE provides a choice of trading environments and tools: traditional open outcry on ICE's trading floor in Lower Manhattan; or electronic trading on the ICE platform. Price data are disseminated through traditional third party vendors. Direct data and analytical tools are available on the Internet through www.NYBOTLive.com – the exchange's own real-time streaming data service. For more information on the many strategic capabilities provided by the ICE marketplace, visit www.theICE.com or contact the exchange directly.

Electronic trading of futures contracts

NYBOT and the IntercontinentalExchange (ICE), the leading electronic energy marketplace, merged on 12 January 2007. NYBOT is now a wholly owned subsidiary of ICE, which is a for-profit, publicly traded corporation. On 2 February 2007, side-by-side electronic trading of NYBOT commodities contracts was launched on the ICE electronic trading platform. NYBOT contracts offered for electronic trading include cocoa, coffee, cotton, orange juice and sugar.

With the introduction of ICE, contract specifications and commodity codes remain unchanged for both floor and electronic contracts, which will be fungible with one another. The nearest 10 delivery months are available for trade. NYBOT open outcry trading hours for cotton remain unchanged: 10.30 a.m. to 2.15 p.m., Monday through Friday. Electronic trading in cotton is currently offered between 1.30 a.m. and 3.15 p.m. Eastern Time. A pre-open market facility is available between 8:00 p.m. and 1:30 a.m. Eastern Time to allow participants to enter bids and offers that will be executed after the electronic market opens, on a first-in first-out (FIFO) basis. There are no changes to the current NYBOT/ICE exchange fee structure, with floor and screen trades offered at existing, equivalent rates. There is one daily settlement price established for each futures contract month each trading day. Open positions are marked-to-market each day using the settlement price, regardless of whether the position was initiated via electronic or open outcry trading. The daily settlement price is determined at the close of the contract's open outcry trading session. Trading floor brokers are key providers of liquidity, have full access to the electronic system and can execute trades in the electronic system on behalf of their customers.

Access to electronic trading is available to qualified individuals, regardless of membership status, upon execution of an access agreement with ICE. ICE believes that offering electronic trading in agricultural futures products alongside the traditional open outcry trading allows both existing and new customers worldwide maximum flexibility in accessing these markets and gives them the ability to choose how best to take advantage of the broad liquidity of these contracts.

During February 2007, the first month of side-by-side trading of NYBOT/ICE open outcry and electronic trading of cotton futures, 713,894 cotton futures contracts were traded, including 120,503 contracts traded electronically, or 17% of the total. The volume of cotton futures contracts traded in February 2007 exceeded February 2006 volumes by 44%. During March 2007, 375,964 cotton futures contracts were traded, including 107,048 contracts traded electronically, or 28% of the total. During April 2007 a record of 765,244 contracts were traded, including 244,279 contracts traded electronically (32%).

Other futures markets

Brazil

The São Paulo Commodity Exchange was established in 1917. It first traded cotton futures in 1919, with a contract size of 500 arrobas (equivalent to 7,500 kg). In 1922, the trading volume reached 14,000 contracts and by 1926 cotton-related activities were the exchange's major source of income, followed by sugar and rice. However, in the three-year period following the 1929 financial crisis the volume dropped by 90% compared to the same period prior to the crisis.

Trading of cotton futures at the São Paulo Commodity Exchange flourished during the Second World War (unlike the European exchanges, which suspended operation), with a trading volume of 43,000 contracts in 1941 and an average of 200,000 contracts between 1944 and 1946. Political instability, restrictions on capital movements and inflation of around 40%, however, caused futures trading to decline in the early 1950s; gradually, the cotton futures market lost its importance and the contract ceased trading. Although the contract was reinstated during the mid 1970s, it never gained importance. In 1989 the contract ceased trading once more, leaving NYBOT, now ICE, as the only exchange in the world trading cotton futures.

The recent cotton contract

In November 1996 the São Paulo Commodity Exchange (BM&F – see www.bmf.com.br) reintroduced the cotton contract (along with numerous other commodities), and in December 1999 the contract was offered to foreign investors. In February 2000 options were introduced on all futures contracts, including cotton. Initially, the contract size was just 10,000 pounds, or one-fifth of the New York cotton futures contract. In 2002 the BM&F cotton contract size was changed to 12.5 tons or 27,558 pounds, roughly half the size of the New York cotton futures contract. The new São Paulo contract is delivered to various locations in Brazil in the months of March, May, July, October, and December. The design of the BM&F contract is very similar to that of the New York contract. The contract is quoted and traded in United States dollars per pound but is settled in real. The exchange rate used for settlement is the one reported by the Central Bank of Brazil. In effect, therefore, trading the São Paulo cotton contract also implies the undertaking of dollar-real exchange rate risk.

It was anticipated that the contract could serve as a hedging instrument for South American cotton producing countries given that the region's crop (part of the Southern Hemisphere's crop) moves within a different time frame to that of the United States crop (part of the Northern Hemisphere's crop), the principal influence of the NYBOT, now ICE, contract. The volume has been far below expectations as the contract has failed to attract considerable attention from hedgers and speculators.

During its first year of existence, the cotton contract was regularly traded on a daily basis. However, trading volume remained relatively small, averaging just 58 contracts a day, the equivalent of about 290 tons of cotton. Contract volumes traded since 2000 remain small. During 2006 a total of 2,920 cotton contracts or 36,500 tons of cotton were traded at BM&F, compared with 3,338 contracts or 41,725 tons traded during 2005. Daily volumes averaged 12 contracts or 150 tons during 2006 and 13 contracts or 163 tons in 2005. During the first two months of 2007, BM&F cotton futures contracts totalled just 272 contracts. This lack of volume could be explained by direct

competition from the NYBOT cotton futures market, as cotton market participants operating in Brazil, as well as speculators, have access to that market as well as BM&F.

China

The Shanghai Cotton Exchange, which was established with the help of British and Japanese traders involved in the successful opening of the Osaka Sampo Exchange, introduced futures trading in 1911 trading Chinese cotton production. During the 1920s Shanghai's cotton exchange volume equalled about one-third of the Chinese production. The trading volume fluctuated significantly in the 1930s. The Exchange closed in 1941 following the outbreak of the Second World War. In May 1977 the Hong Kong Commodity Exchange introduced a cotton futures contract, along with contracts on sugar, soybeans and gold. In its first year of operation it traded 1,151 contracts. After surviving a difficult year in 1979 with a trading volume of only 507 contracts, its turnover reached 14,630 contracts in 1980. Cotton futures trading at the Hong Kong Commodity Exchange lasted only four years because of lack of interest, and in 1981 the contract was delisted from the exchange.

The Zhengzhou Commodity Exchange

On 1 June 2004 The Zhengzhou Commodity Exchange (ZCE – see www.cottonchina.org) in China launched a new futures contract called Cotton # 1 Contract, and quickly achieved large volumes of contracts traded. ZCE is one of three futures exchanges in China. It was established in 1990 and in 1993 started futures trading in agricultural commodities. Wheat, sugar, cotton and pure terephthalic acid (PTA, used in the production of polyester), are the four other commodities currently traded at the exchange.

The Cotton # 1 Contract is 5 tons (about one-fifth of the size of the New York contract) for deliverable grade 328 at 13 approved, exchange-appointed warehouses, for saw ginned cotton, with 11 trading months; February is the only month excluded. The maintenance margin is 7% of contract value (about the same as in New York) and the daily price change limit is set at 4% of the previous day's settlement price (also about the same as in New York). The trading fee is set at 8 yuan (RMB) per contract, equivalent to about \$1 per contract. Trading fees in New York range from \$0.50 to \$1.35, depending on the account for which the trade is executed (floor broker, member, non-member).

The major elements of success of the ZCE Cotton # 1 Contract lie in the integrity of the contract design: it is easy to make and to take delivery of cotton with assured quality. China's Fibre Inspection Bureau tests cotton quality at the warehouse entry point and at delivery. The base quality of the # 1 contract is grade 328, representing the bulk of cotton produced in China, but other grades are deliverable. Domestic prices in China have been highly volatile historically, encouraging market participants to hedge. Widespread familiarity with futures (obtained during the 1990s when more than 50 futures exchanges were operating) and the large number of speculators helped to create large liquidity for cotton futures from the opening day of the # 1 contract.

The contract proved very successful. It attracted large volumes during its first year and a half of existence, exceeding at times the volumes of cotton traded in New York. Between June 2004 and December 2005 a total of 27.7 million contracts, or 138.6 million tons, were traded at ZCE. The average monthly volume traded during the period was 1.5 million contracts, or 7.5 million tons. Trading volume reached a daily record of 156,072 contracts traded on 26 October 2005, and open interest reached a record of 110,442 contracts on

11 April 2005. The largest monthly volume of Cotton Contract #1 was 2.2 million contracts in July 2005, and during the second half of 2005 volumes were close to 2 million contracts a month.

However, cotton-trading volumes at ZCE declined sharply in 2006. Between January and December 2006, a total of 5.1 million cotton contracts, or 25.5 million tons, were traded, averaging 420,000 contracts or 2.1 million tons a month. The largest trading volume during 2006 was reached in August, when 1.1 million tons were traded, while the smallest monthly volume of 100,000 contracts was recorded in September 2006. During most of 2006, cotton prices in China were relatively stable. Coincidentally, a new sugar futures contract was introduced at the start of 2006. As a result, a large volume of speculative trading in 2006 shifted from cotton to sugar, causing sugar contract volumes to rise while cotton volumes declined to a quarter of their 2005 level. Speculators dominate the ZCE futures market, while the share of hedgers is minimal. During the first four months of 2007, trading volumes in cotton futures at ZCE remained relatively low, totalling 620,000 contracts, 76% less than during the same period in 2006.

ZCE has 222 members, including 27 that are State-owned. Of its members, 179 are futures brokerage firms, while 43 are non-futures-brokerage firms. Only 28 firms are based in Henan province. All trading is done electronically, with no open outcry. Physical delivery in all contracts has not exceeded 0.5% of traded volume. ZCE cotton prices are an important factor in determining domestic prices for physical cotton in China and are taken into account by most of the mills when making purchasing decisions. In addition to fundamentals, the ZCE prices also reflect Government actions that affect the supply and demand situation in the domestic market.

Since the ZCE contract represents only Chinese cotton delivered to domestic locations, there is no correlation between New York futures and ZCE futures, and there are no efforts to balance trades between the two markets.

ZCE has signed memoranda of understanding with NYBOT, BM&F and the Chicago Board Options Exchange (CBOE) aimed at sharing information and expertise, training, organizing seminars, developing new exchange products and cooperation. ZCE is working on developing new products, and cotton options could be introduced at the exchange soon.

India

India has a rather long history of futures trading. Trading of cotton futures started informally in 1875 after the country emerged as a major cotton exporter, following the disruption in supplies of United States cotton to the United Kingdom due to the American Civil War. Cotton futures trading was formally introduced in 1922 when the Government of Bombay enacted the Cotton Contracts Act which granted recognition to the East India Cotton Association and gave it the authority to administer a cotton futures contract equivalent to 19,600 pounds. Because of price ceilings imposed by the Government, the futures market closed in 1929. When it reopened in 1932, more regulations were put into place. In 1952 the Government prohibited the trade of options (under the Forward Contracts Regulation Act) and also limited the flexibility of the futures contract, making it similar to a forward contract. In 1966 the Indian Government prohibited the trade of cotton futures altogether (along with a number of other commodities).

The recent cotton contract

The National Commodity & Derivatives Exchange (NCDEX – see www.ncdex.com) in Mumbai started futures trading in December 2003. It is the

largest commodity exchange in India by volume traded and is currently trading 44 commodities, including cotton. Contract size is 50 bales of 170 kg (8.5 tons) for all contracts except for medium staple cotton, which is set at 55 bales (9.35 tons). The long staple cotton contract was traded between October 2004 and July 2005; a total of 77,000 bales of 170 kg (13,090 tons) were traded during that period. The largest volume of 61,050 bales (10,379 tons) of long staple cotton was traded at the exchange in March 2005. The Indian 31 mm cotton contract was traded between October 2005 and January 2006 only, with a total volume traded of 10,800 bales (1,836 tons). Indian 28 mm cotton was traded between October 2005 and February 2006 with a total volume of 22,800 bales (3,876 tons). The currently active contract with the largest volume is medium staple cotton, which started trading in October 2004.

Total volumes of all cotton contracts traded through July 2006 reached 2.13 million bales or 361,539 tons. The largest cotton futures trade volume of 35,455 tons was reached in December 2004. Large volumes were also traded between December 2005 and July 2006, totalling 146,466 tons.

The medium staple contract now covers all cotton traded as J 34 (SG) with a base staple length of 25.5 mm and tenderable range of 24–27 mm, with no premium above 27 mm. The delivery centre is located at Abohar (Punjab), but delivery is also allowed at Sirsa (Haryana), Hanumangarh and Sriganganagar (Rajasthan). Hours of trading are 10 a.m. to 5 p.m. Monday through Friday, 10:00 a.m. to 2 p.m. Saturday. Trading and delivery months are January, February, March, May, July, August, October, November and December. A special margin of 4% of the value of the contract is levied whenever prices change by more than 20% compared with the price settled 90 days.

There are currently 700 members of the exchange who can trade electronically at 858 terminals located at 553 exchange centres across India. Members can trade for their own account or for their clients' accounts. Individuals, sole proprietors, partnership firms, cooperatives, corporations, companies as defined in the Companies Act of 1956 and other persons or entities as may be permitted under the Forward Contracts (Regulation) Act of 1952 are eligible for membership. The major shareholders of the exchange are banking organizations.

Information on prices, volumes, deliveries, contract specifications, rules and educational materials are provided on the exchange's website. The exchange declares that the major functions of this market are to provide a trading platform, price discovery mechanism, speculation and hedging tools. According to exchange data, more than 80% of contracts are closed by physical delivery of commodities, compared with less than 1% of contracts at ZCE in China. This means that there are few speculators participating in this market, and as a result a limited number of hedging operations exist at this exchange. Rather, participants use this market mostly as a trading platform, price discovery tool and physical trade forward contracting.

The Multi Commodity Exchange (MCX) is an electronic trading platform based in Mumbai, which has 1,000 members in 500 cities across India. The exchange offers futures contracts in medium and long staple cotton as well as in kapas (seed cotton). Cotton contracts started trading in April 2005. Contract specifications are very similar to the NCDEX contracts, but the volumes traded are substantially smaller, though rising. The largest volume for a single cotton contract so far was the May 2006 medium staple contract, with total traded volume of 5,365 tons. Six trading months are offered at the exchange, but based on available statistics traders do not take very long positions. Most positions are taken a month or two before the expiration of the contract. As in the case of NCDEX, most settlements result in the physical delivery of commodities.

Trading in futures

Overview

Floor procedure

In traditional open outcry or floor-based trading, the initiation of a contract transaction takes place on the floor of the exchange. Unlike the physical market, no privately arranged deals are allowed. The transaction is negotiated across the floor, giving all participants an opportunity to respond to the current bids and offers. The negotiation is concluded the moment a buyer and a seller agree with each other and the seller registers the contract as a sale to the clearing house. Thereafter, the two traders are responsible only to the clearing house. In this way, the clearing house is a party to every transaction made by both buyers and sellers.

Automated or electronic trading is different but maintains the transparency of open outcry trading in that all bids and offers can be viewed by all participants. The computer system matches equivalent bids and offers without human intervention. Once the orders are matched, the clearing procedure is exactly the same as the old open outcry system.

Futures contracts are standardized in that all terms are given, except the exact date of delivery, the names of the seller and buyer, and the price. The market rules are legally enforceable contract terms and therefore cannot be substantially altered during the period of the contract. Every futures contract specifies the quantity, quality, and condition of the commodity upon delivery, the steps to be taken in the event of default in delivery, and the terms of final payment.

Delivery

Most futures transactions do not result in physical delivery of the commodity.

Depending on their strategy, futures traders usually make conscious decisions either to avoid delivery or to accomplish it. That is, they either make an offsetting transaction ahead of the delivery, thereby avoiding physical cotton being tendered to them; or they consciously force the exchange to deliver (tender) physical cotton by allowing the contract to fall due. Delivery must be completed between the first and the last trading days of the delivery month, although the exact terms vary from one market to the other.

While the futures contract can be used for delivery, its terms are not convenient for all parties. For example, the terms of delivery of futures contract provide the seller with the exclusive right to select the point of delivery. This situation can obviously create difficulties for the buyer. In addition, the actual cotton delivered, while acceptable under the futures contract, may not match the buyer's specific quality needs.

Offsetting transactions

A trader who *buys* a futures contract and has no other position on the exchange is *long*. If this purchase is not eventually offset by an equivalent sale of futures then the buyer will have to take delivery of the actual commodity.

Alternatively, a trader who *sells* a futures contract without an offsetting purchase of futures is said to be *short*. Traders who have taken either position in the market have two ways of liquidating it. The first involves the actual delivery or receipt of goods. Most traders choose the second option, which is to cancel

an obligation to buy or sell by carrying out a reverse operation, called an *offsetting transaction*. By buying a matching contract a futures trader in a short position will be released from the obligation to deliver. Similarly, a trader who is long can offset outstanding purchases by selling.

Open interest. The total of the clearing house's long or short positions (which are always equal) outstanding at a given moment is called the open interest. At the end of each trading day, the clearing house assumes one side of all open contracts: if a trader has taken a long position, the clearing house takes the short position, and vice versa. The clearing house guarantees the performance of both sides of all open contracts to its members, and each trader deals only with the clearing house after initiating a position. In effect, therefore, all obligations to receive or deliver commodities are undertaken with the clearing house and not with other traders.

Futures prices

Futures prices and spot prices. Futures markets provide a public forum to enable producers, consumers, dealers and speculators to exchange offers and bids until a price is reached which balances the day's supply and demand. Only a negligible proportion of the physical cotton trade actually moves through exchange markets. The futures price is intended to reflect current and prospective supply and demand conditions whereas the spot price in the physical market refers to the price of cotton for immediate delivery. In the futures market the spot price normally reflects the nearest futures trading position.

Carries and inversions. When the quotation for the forward positions stands at a premium to the spot price, the market is said to display a *carry* (also called *forwardation* or *contango*). The price of successive forward positions rises the further away they are from the spot position. In order to provide adequate incentives for traders to carry stocks, the premiums for forward positions must cover at least part of the carrying costs of those who accept ownership. Therefore, when stocks become excessive, the futures market enables operators to enter the market to buy the commodity on a cash basis and to sell futures, thereby carrying it. The carry will eventually rise to a level where the premium covers the full cost of financing, warehousing and insuring unused cotton stocks. This level of the forward premium is known as the full carry. The holders of surplus cotton are now covered for the full costs of holding these stocks.

The size of the forward premium or discount between the various forward trading months quoted at any time reflects the fundamentals of the cotton market. When cotton is in short supply, the market nearly always displays an *inversion* (*backwardation*), with the forward quotation standing at a discount to the cash price. This inversion encourages the holder of surplus stocks to supply them to the spot market and to *earn the inversion* by simultaneously purchasing comparable tonnages of forward futures at a discount to the spot price.

Differences between forward and futures market prices

Forward markets are used to contract for the physical delivery of a commodity. By contrast, futures markets are 'paper' markets used for hedging price risks or for speculation rather than for negotiating the actual delivery of goods. On the whole, prices in the physical and the futures markets move parallel to each other. However, whereas the futures price represents world supply and demand conditions, the physical price for any particular cotton in the forward market reflects the supply and demand for that specific type and grade of cotton, and the nearest comparable growths.

Prices in both physical and futures markets tend to move together because traders in futures contracts are entitled to demand or make delivery of physical

cotton against their futures contracts. The important point is not that delivery actually takes place but that delivery is *possible*, whether this course of action is chosen or not. Any marked discrepancy between the prices for physicals and futures would attract simultaneous offsetting transactions in the two markets, thus bringing prices together again.

However, buying futures in the hope of using the cotton against physical delivery obligations is extremely risky because the buyer of futures contracts does not know the exact storage location or the origin or quality of the cotton until delivery is made. The cotton that is finally delivered may be unsuitable for the buyer's physical contractual obligations, leaving it with more rather than less risk exposure. On the other hand, physical cotton on a forward shipment or delivery contract that is of an acceptable quality can usually be delivered against a short position on the futures market as the buyer can choose the origin and where to make the physical delivery (or tender). This feature makes futures contracts particularly suitable as a hedge against physicals.

Types of orders

Fixed price order for the same day means that an exchange member is asked to buy or sell a given number of lots (contracts) for a particular month at a set price, for instance, two lots (200 bales) of cotton for December at 62 cents per pound. The contract must be completed during the day on which the order is given. If possible, the broker will buy at a lower price but never at a higher price; or sell at a higher price but never at a lower price. This ensures that clients will get the desired price if a contract is made, but they run the risk of not having a contract made at all if the floor trader cannot execute the order on that day.

Fixed price, open order is a similar order, except that the instructions stand for an indefinite period of time until the order is satisfied or cancelled by the client. This type of order is popularly known as 'good till cancelled' (GTC).

Market order is an order that gives brokers more flexibility, and allows them to make a contract for the best possible price available at the time.

Different orders are often made subject to certain conditions. For example, a broker may be instructed to make a contract if the price reaches a certain level. Orders that are conditional on specific terms set by the client can also be made. Examples of such orders are: those to be carried out only at the opening or closing of the market; or those to be carried out within a certain period of time. (Orders have to queue at the opening and closing of the market and are therefore not all filled at the same price, particularly when trading volume is high in an active market. If one stipulates a price then an order may not be executed if that price is not touched, or is exceeded.)

Market orders and fixed price orders for the same day are the most common but orders are also made to suit the requirements of clients. Clients who follow exchange movements closely frequently revise their orders in response to changing market conditions. Those less involved in hourly market movements usually place open orders, or orders subject to certain conditions. For example, a stop-loss order – which is triggered into action as soon as a predetermined price level is reached – limits the client's losses relative to the level at which the order is executed. Placing more general conditions on the order gives brokers greater flexibility to react to changes in the market and leaves the final decision to them.

Positions

Open position or open interest is the number of contracts registered by the clearing house which are not offset by other contracts or tenders when the

contracts become spot (the nearby contract month). For example, a cotton trader may have a position with the clearing house of 30 purchase contracts and 40 sales contracts. Some of the purchases and sales may be for the same delivery month but the trader may have labelled them as 'wait for instructions' if those contracts represent separate hedging transactions for that trader. This means the trader will enter into additional futures deals to offset them once her or she unwinds the physicals against which the original hedge was taken. In other words, the open position of that particular operator remains 70 lots until some of the contracts are offset or 'washed out'.

The clearing house reports only the total of all operator positions, rather than the position of any one member, which is left to the broker to report. CFTC's commitment of traders (COT) report breaks down the total open interest on the NYBOT Cotton No. 2 contract by category of traders. Large traders are called reportable, while small traders are non-reportable. The COT report then further breaks down the open interest by commercial and non-commercial reportable traders. It is a very handy tool for exporters to get an idea of the long or short positions of the large speculative hedge funds.

Margins

Trading deposits (margins) are required upon initiation of a futures trade. Further deposits may be required daily to reflect the changes in the price of the contracts when the market moves against a trader's position. If additional funds are required to restore the original margin (currently \$1,200 per cotton contract for hedgers, equivalent to 2.4 cents per pound or about 4% of the contract's nominal value) then variation margins must be paid in unless adequate security, for example treasury bills, were deposited when the account was established. Conversely, if the futures price move is favourable to the trader, the gains transferred into the account above the margin requirement level become immediately available to the trader.

Original and variation margins are adjusted from time to time for the following reasons: to reflect increased or decreased market levels; to add security to volatile positions, particularly in months carrying no limit; and to discourage excessive concentration of trading positions in any one month. Investors should note that margin requirements can be changed without prior notice.

Financing margins

Financing margin calls on open contracts can make the use of futures markets very expensive for producers and exporters, partly because variation margins are always paid in cash. Any user of futures markets should be aware that unanticipated calls for variation margins can be costly in terms of demands on their cash flow and the interest foregone on cash deposited with the clearing house. Therefore, a user should carefully consider how margin calls will be financed before entering into any commitments. For example, when the market closes 'limit up', in other words 3 cents above the previous close, this translates into a variation margin of \$1,500 per contract, so an exporter with a short of 10 contracts against physical stocks of 226.8 tons would have to pay \$15,000 within 24 hours to meet the margin call. Of course exporters would benefit from the increased value of their physical contracts in a situation like this, but might not always find it easy to convince any but the most experienced commodity finance banks of the validity of this argument.

Technical analysis of futures markets

Technical analysis is the study of the market itself rather than an evaluation of the factors affecting the supply of, and demand for, a commodity. The

important components of technical analysis are prices, market volume and open interest. As this technical approach only considers the market, it must take into account fluctuations that reflect traders' actions and that are not necessarily associated with supply-and-demand cycles. The basic assumption of all technical analyses is that the market in the future can be forecast merely by analysing the past behaviour of the market (although many in the cotton trade find this hard to accept).

Detailed technical analysis is not possible for all or even most traders. The most important elements for accurate decision-making are close contacts with the markets and with knowledgeable individuals in the trade. However, if charting specialists supply the analysis within a usable period of time, technical analysis can provide useful additional information, particularly for medium-term forecasts.

The main tools of analysis are past price patterns that are shown in various forms of charts or graphs. The changes in the volume of open positions (i.e. the number of futures or option contracts outstanding on a given commodity) and the total volume of operations in the market are also examined. Charts often use a moving average to record and interpret price trends. In most charts, an average moves with time as the newest price information is incorporated into the average and the oldest price is discarded. For example, a simple three-day moving average of the daily closing price of a commodity changes as follows: on Wednesday, the sum of closing prices on Monday, Tuesday and Wednesday is divided by three; on Thursday, the sum of closing prices for Tuesday, Wednesday and Thursday is divided by three; and so on. Analysts can average prices over a period of hours, days, months or even years, depending on their needs.

The value of the moving average always lags behind the current market price. When prices are rising in bull markets, the moving average will fall below the current price. However, the moving average in a bear market will be higher than the current price. When the trend in prices is reversed, the moving average and the current price cross each other.

While advocates of charting accept that fundamental factors are the prime determinants of commodity prices, they point out that these factors cannot predict prices. They argue that the graphs incorporate all the fundamental factors that shape prices and also reflect the subjective market reaction to these factors. The alternative argument holds that although the price curve and other elements of the graph are real and objective, the interpretation is necessarily subjective. Thus the same graph can give contradictory signals to different readers.

In reality there is likely to be substantial overlap between the fundamental approach and the charting approach. It is common for operators to determine the market trend by studying fundamental factors and to then select the right time to enter the market by referring to the charts. Similarly, chart advocates also study other factors beyond the limit of technical analysis. They may consider the number of marketing days left before a position expires, the amounts notified for delivery on the exchange, the situation of the longs, and the possibility of accepting deliveries on the exchange without adverse results.

Many companies specialize in producing charts for various commodities and most have their own websites where charting information such as price history, volumes, open interest and technical studies can be accessed.

Open interest and volume of operations

The total of a clearing house's outstanding long or short positions is called the open interest. If a broker who is long in a futures contract sells his or her

position to another trader who wants to be long on futures, the open interest does not change. However, if he or she sells that position to a trader who is short and is therefore closing out his or her position, the open interest is reduced. The total size of the open interest indicates the degree of current liquidity in a given market.

At the end of December 2006, the open interest for the Cotton No. 2 contract was 170,511 contracts (equivalent to 3.87 million tons) compared to 105,414 one year earlier. The open interest for cotton options was 213,415 contracts (equivalent to 4.84 million tons), sharply up on the year (127,789 contracts).

Volume of operations

The volume of operations, or turnover, is equivalent to the number of trades in all futures contracts for a particular commodity on a given day. Technical analysts regard volume and open interest as indicators of the number of people or weight of interest in the market and thus of the likelihood of a price rise. A gradual increase in volume during a price upturn could suggest that the trend will continue.

The rise in volume could also result from an anticipation of higher prices in the future, but, in fact, it may indicate that long or short positions are leaving the market because of a fall in prices. In general, the volume of trade is a good guide to the breadth of the outside support for a price movement on the market.

The total volume of operations on cotton in New York has been rising, from 3,156,018 futures contracts in 2004 to 3,848,990 in 2005 (+22%) and 4,490,407 in 2006 (+17%). On average, about 19,000 contracts (equivalent to 430,000 tons) were traded daily in 2006 compared to only 13,500 in 2004.

The total volume of operations on cotton options in New York reached 1,820,259 contracts in 2006, up 6% from 2005 (1,709,345), and 1,726,982 in 2004. An average of 7,750 options contracts (equivalent to 175,000 tons) were traded daily in 2006.

Relationship between open interest, volume and price

The elements of charting must be interpreted together as they are meaningless on their own. When changes in open interest and volume are analysed in conjunction with the price charts, they may indicate several trends, which are described in the paragraphs that follow.

When both volume and open interest are expanding against a background of rising prices, a *bullish trend* is indicated. A rise in open positions is a consequence of the ongoing entry of new long positions and new short positions into the market. However, with every subsequent upward movement in prices, the shorts that previously entered the market will incur worsening losses that will be increasingly difficult to sustain. Eventually, traders with short positions will be forced to buy, which will add more buying pressure to the market.

A persistent rise in both volume and open interest with prices rising is a good indicator of a bull market. In this scenario more new participants are willing to enter the market on the long side, looking for higher levels. When the volume and open interest start to decline, this could be a signal of a trend reversal. As mentioned earlier, for the New York market, the commitment of traders (COT) report published by CFTC (www.cftc.gov) yields a great analysis of the open interest, not only by trader category, but also by weekly change.

If daily volume and open interest are falling and prices are declining, a *bearish trend* is confirmed. When there are more sellers than buyers in the market, long

positions suffer increasing losses until they are forced into a selling position. Declining volumes together with declining prices in turn mean that it will be some time before the lowest price of the bearish trend is reached.

An explosion of volume can also signal a turning point in the market if a day's trading at very high price levels is recorded against a very large volume and if subsequent price movements, either up or down, are accompanied by lower levels of volume. This is a good sign that a reversal is imminent. Similarly, a collapse in prices after a severe downtrend, recorded against a high volume, can signal an end to the bearish trend.

Charting

The two most commonly used charts in technical analysis are the bar chart, and the point and figure chart. Many technical studies can be added to these charts such as trend lines, moving averages and stochastics (probabilities).

Bar charts use a vertical bar to record the high and low range of a price for each market day. The length of the bar indicates the range between the highest and lowest quotations. The vertical line is crossed by a small horizontal line at the closing price level. Therefore, in just one line per day it is possible to show the closing price as well as the minimum and maximum quotations registered for that day. A record is made daily, forming a pattern that may cover several weeks, months or even years.

Some chartists insist that a new bar chart should be started as soon as a new futures position is opened. However, it is common to continue the original chart with the new position following the position that has just expired. As the new position may have discounts or premiums in relation to the old position, the chart should be clearly marked to indicate where the new position starts and where the old position ends.

Continuous plotting can be done in various ways. One way is to show the first position until it expires and then to continue with the new first position. Another way is to show only one position until it expires and then to continue with the same month of the following year. The drawback of the second method is that if a position expires, for example, in December 2004, and the next position taken is December 2005, prices may have changed significantly and the chart may therefore show either a large increase or decrease.

Trend lines on charts reveal significant trend changes but obscure subtle changes in supply and demand factors. The trend line is best suited for recording long-term changes in indices or other financial and economic data. The market registers three types of trends: a bullish trend when prices are rising; a bearish trend when prices are falling; and a steady or lateral trend when prices are neither rising nor falling. A steady trend sustained for a comparatively long period is known as a congestion area. The larger this area, the greater the possibility that the market will begin a definite trend, either bullish or bearish.

The simplest patterns to recognize are those formed by the three types of trend lines. These are: the support line, which is drawn to connect the bottom points of a price move; the resistance line, which is drawn across the peaks of a trend; and the channel, which is the area between the support and resistance lines that contains a sustained price move.

The **point and figure chart** differs from the bar chart in two important respects. First, it ignores the passage of time. Unlike a bar chart, where lines are equidistant to mark distinct time periods, each column of the point and figure chart can represent any length of time. Second, the volume of trade is unimportant as it is thought merely to reflect price action and to contain no predictive importance. The measurement of change in price direction alone

determines the pattern of the chart. The assumptions underlying the point and figure chart primarily concern the price of a commodity. It is assumed that the price at any given time is the commodity's correct valuation up to the instant the contract is closed. This price is the consensus of all buyers and sellers in the world and is the result of all the forces governing the laws of supply and demand. No other information needs to be included in this chart because the price is assumed to reflect all the essential information on the commodity.

Daily and monthly cotton price futures charts (along with information on volume and open interest) are offered free of charge by TFC Commodity Charts at www.futures.tradingcharts.com and are easy to access.

Hedging and market systems

Global cotton merchandizing is a very capital-intensive industry, so hedging the various risks involved is an absolute must if traders are to gain and maintain success for long periods of time. Any individuals or companies that take ownership of cash cotton should avail themselves of any available hedge. Most of the time the entities involved in the cash trading of cotton are growers, merchants and textile mills.

Predicting accurate future price trends in the cotton market with any consistency is absolutely improbable if not down right impossible for any individual. There are just too many unpredictable occurrences that cause price fluctuations and market volatility for any one person to even guess at what the price will be over any given period of time. Therefore, some form of price risk management is necessary in order for a business to survive the market ups and downs.

Proper hedging is defined by offsetting a purchase or sale of cotton with a countertransaction. When the price is fixed it should be immediately hedged by either a counter cash transaction or a future contract. Since it is rare that back-to-back cash business can be transacted, the most usual countertransaction would be a futures contract.

Risk considerations

The most important risk considerations are price, basis and counterparty risk. Secondary risks are currency, financial and government (i.e. tariffs and trade).

Figure 4.4: Yearly high and low prices

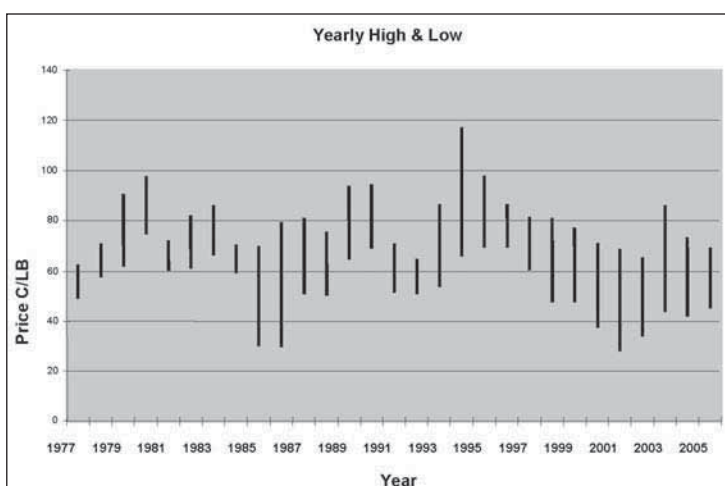

Price risk

Price risk is probably the most volatile risk to which merchants are exposed. Cotton prices can, and will, fluctuate over a wide range from time to time (see figure 4.4), and therefore some manner of price protection must be practised. The most accessible form of price hedging today is a futures contract. There are several cotton future exchanges available to hedgers, but most are very regional and are used to hedge local trade.

ICE offers the best available all-round cotton futures contract providing full

Figure 4.5: Cotlook A Index vs futures



or partial price hedging opportunities. United States cotton can be hedged fully, while growths outside the United States can be partially hedged. Non-United States prices tend to follow the New York futures price, but lag behind (see figure 4.5).

Trade can be conducted up to 24 months in the future and hedged with New York cotton futures. This allows merchants to be able to buy from growers when growers want to sell and sell to textile mills when the mills want to buy.

Basis risk

The basis is defined as the difference between the cash price and the future price. The basis cannot be hedged unless a simultaneous purchase and sale can be transacted, and this is rarely available to traders. The basis changes at a much slower rate than futures, but becomes greater the farther out a contract runs.

Counterparty risk

Counterparty risk has to do with the reliability and credibility of trading partners. It is most important to know with whom you are doing business: with the possibility of trading cotton 24 months out into the future it is important to know whether the counterparties will be able to complete the transaction as contracted.

Currency risk

Most global cotton trade is transacted in United States dollars, but there are risks possible in cases where currency translations are likely. Sometimes these risks can be hedged by buying or selling the currencies involved in the transaction. There is always the possibility, too, that a country may revalue its currency after transactions have been contracted.

Financial risk

Bank financing varies from country to country. While it is rare these days for a bank to fail, it sometimes does happen. When it does happen the affected traders may have to arrange financing with a new institute that may not offer the same terms as the failed bank.

Government risk

While most countries are trading according to World Trade Organization (WTO) guidelines, there is always the chance that a country will impose higher tariffs on trade. Also, a country may impose import or export taxes before contracts can be fulfilled.

Hedging with futures contracts

Cotton is traded both fixed price and unfixed price (on call price). Fixed price is just that. The price is determined at the time of the transacted contract. On-call contracts are transactions in which all of the contract specifications are set except for the price. In the case of a textile mill buying from a merchant, the mill buyer can fix the price within the time limit allowed by the merchant, i.e. buyer's call.

If a merchant sells fixed price cotton to a textile mill, the merchant will immediately go into the futures market and buy a similar amount of futures contracts. The merchant will hold these futures contracts until the cash cotton can be had, at which time the futures contracts will be liquidated. If a merchant sells cotton to a textile mill on call, the merchant will buy no futures contracts until the textile mill fixes the price. The merchant will then go into the futures market and buy futures contracts representing the amount of cotton fixed by the textile mill.

Similarly, the buying of cotton by a merchant from a grower can be transacted both fixed price and on call. If the purchase is on call, the grower has the privilege of fixing the price within the time limit allowed by the merchant. When the price is fixed the merchant will go into the futures market and sell a like amount of futures contracts. The merchant holds the contracts as a hedge until the cotton is sold fixed price, at which time the futures contracts will be liquidated.

If the hedger maintains the practice of completely hedging its cotton position the market position is said to be even, in other words not long or short. All open futures positions must be marked to market and margined on a daily basis. For this reason, the hedger should be adequately financed: some transactions may require open future positions to be in place for many weeks or even months.

Before a cotton merchant buys cotton from a grower or ginner, and before the merchant sells cotton to a textile mill or another merchant, he or she must have some idea of both the buying and selling basis: the difference between the cash price and the future price.

The merchant must calculate the buying basis on which he or she pays the grower or ginner. To do this he or she must calculate the cost of moving the cotton from where it sits, including warehousing, loading, transportation, commissions, etc. To this the merchant's profit is usually added, and this becomes the selling basis. Much of the cotton traded in the global market is contracted for forward delivery. A merchant cannot buy the cotton when the contract is made for forward delivery, because the cost of carrying the cotton, storage, interest and insurance, would wipe out the merchant's profit. Instead of buying the physical cotton, the merchant will buy futures contracts and hold them until he or she buys the physical cotton; at that time he or she would sell the futures contracts.

If the buying basis does not change the merchant will realize all of the profit calculated. However, if the buying basis strengthens he or she will lose part or all of the profit. If the buying basis weakens and the merchant buys the physical cotton at a wider basis then his or her profit will increase. Merchants arrive at the buying basis by calculating the costs of buying the cotton at origin and moving it to an approved location in order to tender it as settlement of a New York futures contract. Assume the buying basis is calculated to be 4.00 cents per pound off, or less than, the futures contract. If the cotton can be bought at 5.00 cents per pound, the basis is considered to have weakened. On the other hand, if the merchant must pay 3.00 cents per pound at the time he or she buys the cotton, the basis is said to have strengthened. A weaker basis at the time the cotton is bought benefits the merchant.

Examples of hedging

In June a global merchant wishes to sell a certain textile mill 1,000 tons (4,400 United States-size bales) of a particular quality of raw cotton for delivery in December of the same year. The merchant cannot buy the cotton in June and carry it until the time to deliver it because the carrying charges would be prohibitive. The merchant calculates that the buying basis will be around the

traditional basis of 4.00 cents per pound off New York December futures, which are trading at around 60.00 cents per pound. The merchant calculates that it will cost 7.50 cents per pound to deliver the cotton from the point of origin to the textile mill. The merchant wishes to gain a net profit of 2.00 cents per pound on the transaction, so offers the cotton to the textile mill at 5.50 cents per pound on December New York, which sets the fixed price at 65.50 cents per pound to the textile mill.

4.00 c/lb off New York future at 60.00 c/lb equals	56.00 c/lb
Costs to deliver the cotton to the textile mill	<u>7.50 c/lb</u>
	63.50 c/lb
Profit	<u>2.00 c/lb</u>
Fixed price to the textile mill	65.50 c/lb

The textile mill agrees to pay the merchant 5.50 cents per pound on December New York futures and the price is fixed at 65.50 cents per pound for the cotton delivered to the mill in December. The merchant wishes to hedge the transaction, so immediately buys 44 December New York future contracts (of 100 bales each) at 60.00 cents per pound.

Suppose that in November, when the merchant buys the cotton to deliver to the textile mill, December New York futures have risen to 65.00 cents per pound. The merchant is able to buy the cotton at the traditional basis of 4.00 cents per pound off December New York futures, and sell the 44 December futures contracts at 65.00 cents per pound, resulting in a cash purchase price of 61.00 cents per pound. As predetermined, it will cost the merchant 7.50 cents per pound to deliver the cotton to the buyer, resulting in a total cost of 68.50 cents per pound. The cotton is invoiced to the textile mill at 65.50 cents per pound, resulting in a cash loss to the merchant of 3.00 cents per pound. However, the merchant had bought 44 December future contracts at 60.00 cents per pound which were sold at 65.00 cents per pound when the merchant bought the cash cotton, resulting in a profit of 5.00 cents per pound on the futures contracts. After deducting the 3.00 cents per pound loss on the cash transaction from the 5.00 cents per pound profit on the futures transaction, the merchant realizes a new profit of 2.00 cents per pound – just as expected.

Suppose that December futures prices have gone down to 55.00 cents per pound between the date when the merchant transacted the sale and when he or she bought the cotton to deliver. The merchant is able to buy the cash cotton at a basis of 4.00 cents per pound off December futures, resulting in a cash purchase of 51.00 cents per pound. Adding the cost of 7.50 cents per pound to deliver the cotton to the mill results in a total cost to the merchant of 58.50 cents per pound. However, the merchant invoices the cotton to the buyer at 65.50 cents per pound and realizes a cash profit of 7.00 cents per pound. Again, when the merchant bought the cash cotton the December futures that he or she had paid 60.00 cents per pound for were sold for 55.00 cents per pound, leading to a loss on the futures transaction of 5.00 cents per pound. The 7.00 cents per pound gain on the cash transaction is partially offset by the 5.00 cents per pound loss on the futures transaction, leaving a net profit to the merchant of 2.00 cents per pound – just as expected.

If the merchant buys cash cotton before making a cash sale, the proper hedge is to sell futures in the amount of the volume of the cash cotton. This hedge works the opposite way to the previous examples. When the merchant buys the cotton, December futures are trading at 60.00 cents per pound. The cash basis is 4.00 cents per pound off December futures, resulting in a cash purchase of the cotton at 56.00 cents per pound. The merchant sells a like amount of future contracts at 60.00 cents per pound in order to hedge the cash transaction.

Imagine that by the time the merchant can sell the cotton to a textile mill December futures prices have risen to 65.00 cents per pound. The merchant calculates that the cost of carrying the cotton totals 7.50 cents per pound and wishes to make a profit of 2.00 cents per pound. Therefore the merchant sells the cotton to a textile mill at a basis price of 5.50 cents per pound on December futures, thereby setting the fixed price at 70.50 cents per pound. At the same time, the merchant buys back the 44 short December futures contracts that were sold when the cash cotton was bought. The results are shown below.

Bought cash cotton	56.00 c/lb
Sold cash cotton	70.50 c/lb
Profit on cash	14.50 c/lb
Sold futures	60.00 c/lb
Bought futures	65.00 c/lb
Loss on futures	5.00 c/lb
Profit on cash less loss on futures	9.50 c/lb
Carry and delivery costs	7.50 c/lb
Profit on transaction	2.00 c/lb

Hedging with options

Some degree of price protection for growers and textile mills can be achieved by utilizing derivatives, or options, on futures. In 1984 NYCE first offered options on futures contracts. This action offered a whole new means of price protection for buyers and sellers of cotton. Options on futures are being used more and more around the world by both growers and textile mills. Generally merchants do not use options to hedge except to create a synthetic future which involves the buying and selling of options. However, merchants are, and should be, capable of incorporating options in contracts with growers and textile mills.

There are two types of options on futures, call options and put options.

Call options

A call option gives the buyer of the option the right, but not the obligation, to a 'long' futures contract at a specific price for a given period of time. The seller of a call option has an obligation to deliver to the buyer a long futures contract, and must margin the call option in the same manner as a future contract.

Put options

A put option gives the buyer of the option the *right*, but not the obligation, to a 'short' futures contract at a specific price for a given period of time. The seller of a put option has an *obligation* to deliver to the buyer a short futures contract, and must margin the put option in the same manner as a future contract.

Using options

Call options and put options can be used to develop minimum price strategies for ginners or exporters and maximum price strategies for textile mills. The exporter and the textile mill do not have to trade the options directly. The merchant can incorporate them in the contract at the time of pricing either a fixed price or an on-call contract.

Guaranteed minimum price contract

Imagine a trader is offered a quantity of cotton by a grower but the grower does not want to fix the price of the cotton just yet. The grower may have reason to believe that prices will rise in the near future but not want to carry the cotton because of the charges involved. However, the grower wants some protection in case prices move downward instead. The trader could enter into a guaranteed minimum price contract in the following way.

Assume that futures are trading at around 54.00 cents per pound and the grower agrees to sell the quantity of cotton to the trader at a basis of 4.00 cents per pound off futures. If the trader incorporates a put option in the basis he or she could guarantee the grower a minimum price for the cotton in the following manner. Assume a 50.00 cents per pound put strike premium costs 2.00 cents per pound. The trader buys a 50.00 cents per pound put option for 2.00 cents per pound for the grower which is added to the basis, resulting in a new basis of 6.00 cents per pound off futures. This strategy guarantees the grower a minimum price of 44.00 cents per pound no matter how low prices ultimately go.

Say future prices go as low as 40.00 cents per pound and the grower decides to fix the price on the cotton which has already been invoiced to the trader. The price will be fixed at 34.00 cents per pound, 40.00 cents per pound minus the 6.00 cents per pound. However, the put option will have gained at least 10.00 cents per pound in value which will be credited to the grower. Add that to the 34.00 cents per pound the grower receives for the cotton, and that brings the price back up to the guaranteed minimum price of 44.00 cents per pound.

If the futures market does go up as the grower thinks, the put will expire worthless but the grower will have the opportunity to fix the cotton at the higher price.

Guaranteed maximum price contract

With a call option

Example 1. A textile mill buyer enters into a contract with a merchant for cotton to be delivered during June and July. Everything in the contract is established except the price; an on-call contract. The basis price of the contract is 7.50 cents per pound on July New York futures, which are trading at 54.00 cents per pound. The cotton buyer does not think prices will rise much but wants some insurance in case prices do rise. The buyer elects to get the seller to incorporate a July 58.00 strike call option that is trading at 1.50 cents per pound. The buyer will then have a guaranteed maximum price of 67.00 cents per pound. Simply add the basis and the price of the call option together to establish a net basis of 9.00 cents per pound on July and add that to the call strike price to arrive at the maximum guaranteed price.

Before the call option expires the July futures price rises to 66.00 cents per pound. The buyer decides to fix the price of the contract at that level. Add to the 66.00 cents per pound the net basis of 9.00 cents per pound to arrive at a fixed price of 75.00 cents per pound. Deduct the 8.00 cents per pound value of the July 58.00 call option to arrive at the guaranteed maximum contract price of 67.00 cents per pound.

If futures prices go down, the buyer will have an opportunity to fix the contract at a lower price and the option will expire with no value.

Example 2. A textile mill buyer enters into a contract with a merchant for cotton to be delivered during June and July. The basis price that the cotton was contracted at is 7.50 cents per pound on July New York futures, which are trading at 54.00 cents per pound, making the fixed price of the contract 61.50 cents per pound.

The buyer does not think that prices will go down but wants some price insurance in case they do. The buyer decides to incorporate a July 50.00 strike 'put option' into the contract, at a cost of 1.50 cents per pound. The 1.50 cents are added to the buying basis, resulting in a net basis of 9.00 cents per pound on July futures. The fixed price of the contract is now 63.00 cents per pound, a guaranteed maximum price contract. Suppose that futures prices do in fact go down, to 44.00 cents per pound. The put option will now have a value of

6.00 cents per pound. The option will be closed out and the 6.00 cents would be rebated to the buyer, making the net price of the contract 57.00 cents per pound instead of 63.00 cents per pound.

If prices do rise, then the buyer has the cotton bought at a price lower than the market.

These are just two basic examples of how options on futures are used in order to gain some measure of price protection in what is usually a very volatile market. Most sellers of United States cotton will incorporate the cost of the option, called the premium, into the price of the contract, thereby saving buyers the time and trouble of making the option transaction themselves through a futures broker. However the strategy works the same regardless of the purchase method.

The cost of the premium works the same as almost any insurance premium in that the cost depends on the amount of price protection, or insurance, the buyer wants. The greater the protection desired, the more costly the premium will be.

Trading physicals at a price to be fixed (PTBF)

*Forward sales of physical cotton at a fixed price are the most straightforward form of price risk management as part of marketing. The size of the expected crop is reasonably well known, prices are satisfactory, and buyers have enough confidence in the seller to commit to them on a forward basis. This is perhaps the ideal situation, but it is seldom encountered nowadays. And when prices are very low, fixed price forward contracts look attractive only to the buyer. When the market outlook is very uncertain, many traders and spinners are reluctant to purchase physical cotton outright on a forward basis. The international trade has therefore developed a system of selling cotton without specifying a price for it, i.e. selling at a **price to be fixed (PTBF)** against the futures markets (or the Cotlook A Index). A relevant delivery month of the futures market is chosen, and its price at a given moment will determine (or fix) the price of the physicals contract. If the quality of the physicals is worth more or less than the quality on which the futures contract is based, the price stipulation will read (for example) ‘3 cents per pound on (or off) December’ – the plus 3 is the differential.*

The contract constitutes a firm agreement to deliver and accept a quantity of physical cotton of a known quality, under established conditions. These conditions are based on the quotation for the specified delivery month of the futures market at the time of fixing, plus or minus the agreed differential. The advantage to the buyer and seller is that each has secured a contract for physical cotton, but the price remains open. The PTBF sale sets the differential the buyer will pay in relation to the underlying futures position(s), but the general price risk and the decision when to fix remain entirely open. In other words, the PTBF sale does not mean the seller has made a price decision – that will be the case only once he or she fixes.

In other words the seller and the buyer have now separated the operational decision to sell/buy physical cotton, from the financial decision to fix the price of that cotton, which they prefer to postpone. This arrangement provides flexibility for both buyer and seller. The obligation to deliver and accept physicals now exists but, as the price remains open, both parties can continue to play the market. The producer should realize they have only secured the market differential and that they remain exposed to price risk until an instruction is given to fix. But they have secured a home for their physical cotton, enabling them to plan ahead and to make arrangements for quality control, delivery and shipment.

PTBF – Seller’s call contracts

- ❑ Generally are written to allow the price to be fixed by the seller prior to the first notice day for the specified futures contract.
- ❑ Allow the seller to ask the buyer to fix the contract price based on the futures price ruling at the time (therefore do not require the seller to have a futures trading account).

PTBF – Buyer’s call contracts

- ❑ Sometimes allow the buyer to fix the price any time before the delivery of the physicals, but usually before the first notice day of the specified futures contract.
- ❑ Allow the buyer to ask the seller to fix the contract price based on the futures price ruling at the time (therefore, do not require the buyer to have a futures trading account).

Guaranteed minimum price contracts

Volatility has always been one of the main concerns for producers in the cotton market. Over the last five years, the average annual market movement in cotton has been 15 cents per pound. Volatility such as this means that each and every producer unwittingly becomes a speculator. In these circumstances, it is no surprise that many producers find themselves unable to manage their position, and as a result they often lose money.

One of the roles of the cotton merchant is to offer the producer a variety of tools to try to protect themselves against this volatility. Amongst these tools is the guaranteed minimum price contract.

The only market that facilitates the use of a tool such as the guaranteed minimum price contract is the ICE futures market. However, one of the concerns of producers outside of the United States is that ICE futures have no relevance to their cotton. When ICE is mentioned to non-United States producers, they tend to reply, 'What has New York got to do with my cotton?', or 'I cannot deliver my cotton in New York'.

However, there is a strong correlation between the direction of ICE futures and the direction of world prices, as figure 4.6 shows.

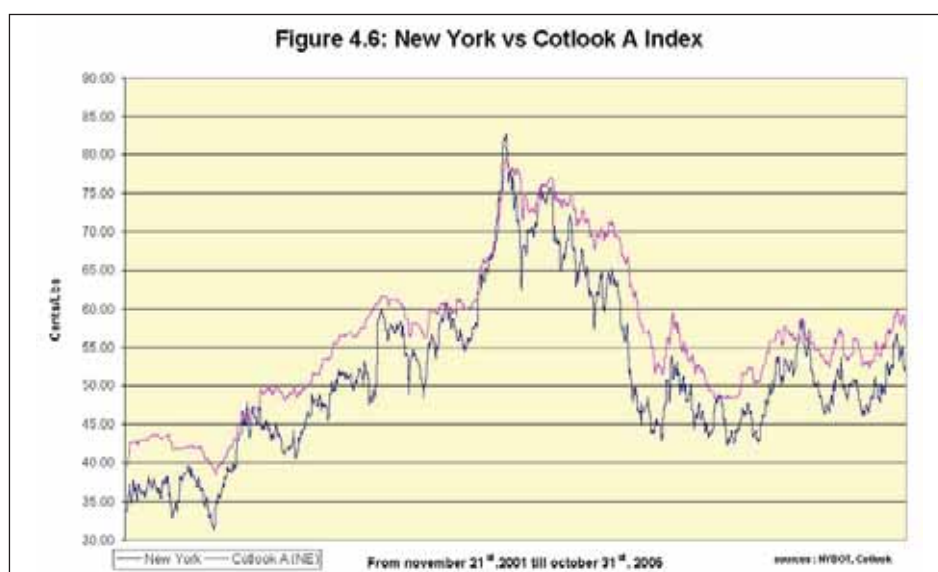

The purpose of the guaranteed minimum price contract

The purpose of the guaranteed minimum price contract is to sell cotton at an established price and maintain the potential for price improvement, with no downside risk. In other words, if the producer sells to the merchant today and the price then starts to rise considerably, the producer can participate in the market rise.

When to use the guaranteed minimum price contract

- ❑ When the market allows the producer to sell at or above his or her break-even price, but the producer feels there is still the potential for more market increases.

- ❑ To allow the producer to deliver the cotton and receive the money today, while still participating in future upside price potential.
- ❑ If the producer believes in future upside price potential, but needs to make a sale in order to obtain finance.

The advantages of the guaranteed minimum price contract

- ❑ Reduces forward price risk. In other words, if the producer does not yet have the cotton to deliver, but can sell forward at a price that is above break-even, then the producer can lock in this price rather than wait and risk a market collapse.
- ❑ Permits a producer to set a floor price for his or her cotton, while still allowing participation in the upside price potential.
- ❑ Allows the producer to have access to exchange-based markets without having to cope with brokers, margin calls and complex financing arrangements.

The disadvantages of the guaranteed minimum price contract

- ❑ Like any form of insurance, there is a cost involved.
- ❑ Obviously, like car insurance, if there is no accident, there will be a cost but no return. If the market does not rise, or if the market falls, then there will be no change in the sale price of the contract.

The workings of a guaranteed minimum price contract

- ❑ First of all, the buyer and the seller must come to an agreement for the fixed price of the cotton to be bought and sold (fixed price).
- ❑ The seller must try to quantify the risk that he or she wishes to insure, and what he or she is willing to pay for it (insurance premium).
- ❑ The guaranteed minimum price contract is the fixed price less the insurance premium.

How to value insurance premium

Take the example of car insurance. Three factors need to be taken into account.

- ❑ The value of the car (cotton) – if the car is old and inexpensive, and the value is low, then this will be reflected in the cost of insurance. If the car is a new and expensive car, and the value is high, then this will result in a slightly higher insurance premium.
- ❑ The length of time over which the insurance is to run. To insure a car for 3 months will of course cost less than to insure a car for a full year.
- ❑ Volatility. In other words, the number of accidents the owner has had in the past. If the owner has been involved in no accidents, then the insurance premium will be lower than for a driver who has been involved in multiple accidents. Needless to say, these accidents may not have been the owner's fault! It is exactly the same for the cotton market. If the market has seen strong movements in the last few months, then a higher insurance premium will be needed than if the market has not moved. After all, the market has become a more dangerous place.

A practical example

Imagine it is September 2007, and a producer in Senegal wishes to sell his or her cotton to a trader. He or she knows that between January 2008 and March 2008 he or she will have 2,000 tons per month. The producer therefore calls the trader to ask for a price, and the trader gives a fixed price of 60.00 cents per pound for the cotton, with delivery January through March 2008.

At the same time, assume the March 2008 contract on ICE futures is at 62.00 cents per pound.

The producer agrees with the market price, and knows that at this price he or she will not lose money, but believes that the ICE market may continue to rise over the next few months. So he or she asks the trader how much it will cost to change the contract to a guaranteed minimum price contract. As explained above, this cost will be deducted from the price of the contract. In this example, the trader says that the cost of the guaranteed minimum price contract is 2.00 cents per pound, and so the final price of the contract will be 58.00 cents per pound.

At 58.00 cents per pound the producer is still comfortable with the sale, and as a bonus he or she gets to participate in any potential upside to ICE futures. If the March 2008 ICE contract moves up to 67.00 cents per pound before a specific date mentioned in the contract, the producer has the right to fix the guaranteed minimum price contract and add 5.00 cents per pound to the price, making the final price 63.00 cents per pound.

If the ICE futures market does not move up, or moves down, then there will be no change to the contract price. If this is the case, then the producer may say that he or she would have been better off just selling the cotton, rather than buying guaranteed minimum price insurance. With hindsight, this is true – but hindsight is a luxury the producer does not have. If the producer wishes to speculate, and take the risk that the market can move up or down, then that is his or her decision to take. If the producer wishes to be protected from a market collapse, and also retain the possibility of benefiting from potential price increases, then he or she should consider the guaranteed minimum price contract.

Remember that the prices of ICE futures are published live online, so a producer selling with a guaranteed minimum price contract can follow the price of the market and decide when to fix the price of the contract.

Conclusion

As long as producers understand the risks they take when producing and selling a cotton crop, then the guaranteed minimum price contract is a very useful tool to manage their market risk, and to maintain the potential for future market gains, while protecting them from a market collapse.

Chapter 5

Market segments

Types of cotton

The cotton plant is a perennial tree that has been domesticated to be cultivated as an annual crop. Cotton is a warm climate crop and is mainly grown between 37°N and 32°S. The northern hemisphere accounts for about 90% of global cotton production. The time of planting in the northern hemisphere is the time of harvesting in the southern hemisphere.

There are many different varieties and types of cottons. Their characteristics determine the use for the cotton, and hence its value. Cotton is a member of the order Malvales, family Malvaceae, genus *Gossypium*. The genus *Gossypium* consists of 50 wild and cultivated species, out of which only four are grown on a commercial scale in the world. *Gossypium hirsutum* and *G. barbadense* are called New World species and account for about 95% and 3% of world production respectively. *G. arboreum* and *G. herbaceum* are called Old World or Asiatic cottons and are grown commercially in India, Pakistan and parts of South-east Asia, accounting for about 2% of world production.

Extra long staple Egyptian, American Egyptian or Pima and Sea Island cotton belong to the species *Gossypium barbadense*. The fibre in this group is long, fine and strong with a staple length in excess of 32 mm (1-1/4"), a micronaire value below 4.0 and a strength of up to 40 g/tex.

The fibre of Old World cottons is generally shorter than 25 mm (1") and coarse, with a micronaire value above 6.0.

Worldwide about 500 varieties are used for commercial cotton production. Most of them Upland species.

Fibre specifications (the intrinsic quality of lint) primarily depend on the varieties grown, agro-climatic conditions and crop management practices. Variety is the most important factor as it determines nearly all the lint quality parameters and most of the agronomic ones. The environment, or growing conditions, determines whether the cotton meets its varietal potentiality.

According to ICAC, world cotton supply can be divided into six categories based on commonly perceived competitive relationships between cottons of differing quality, variety and geographic origins: extra-fine, fine, high-medium, medium, coarse count and waste/padding. The categories are roughly parallel to staple length categories¹⁰ but are designed to incorporate more than just staple length information because two cottons of equal length might actually have significantly different spinning characteristics.

10 Short (under 13/16"); medium (13/16" to 1"); medium long (1-1/32" to 1-3/32"); long (1-1/8" to 1-11/32") and extra long (1-3/8" and longer).

Extra-fine, fine and high-medium cottons are typically used in ring spinning for the production of combed yarn. Medium cotton is typically used in ring spinning for the production of carded yarn.¹¹ Coarse count cotton is typically used for producing open end yarn.

Cotton is traded according to its type. All other things being equal, spinners pay a higher price for longer, finer and more resistant cotton lint that is white, bright and fully mature.

Traditionally, the price of cotton was largely determined by factors such as staple length, grade, colour and micronaire. The textile industry has been striving to improve quality and efficiency through automatic high-speed machinery, which requires better fibre characteristics to operate at maximum efficiency and spin high quality yarns. This has increased the importance of other properties of cotton: strength, uniformity, maturity, fineness, elongation, neps, short fibre content, spinning performance, dyeing ability and cleanliness.

Following the global trend toward improving yarn quality, the market share of medium and higher grades is rising, while the share of shorter ('coarse count') Upland cotton is declining. Medium and higher grades of Upland cottons now account for an estimated 75% of world trade, or some 7 million tons. The fastest-growing and most remunerative market for Upland cottons is for higher grades and finer cottons which can be used for producing ring spun combed yarns¹² for the woven and knitted apparel sector.

Price differentials

Cotton is not a homogeneous product. However, cotton is traditionally treated as a homogeneous commodity and priced against the levels of established benchmarks. The recognized benchmark for international cotton prices, the Cotlook A Index, is based on the representative offering price for a 'basket' of the medium grade cottons most commonly traded internationally. Those quotations refer to a common quality: Middling 1-3/32". Quotations for major growths are published daily by Cotton Outlook (www.cotlook.com). Usual price differentials for grade and staple length for most origins are published every four weeks in the ICA value differences circular (www.ica-ltd.org).

Conventional cotton

Conventional cotton production relies heavily on the use of agro-chemicals.¹³ It has been estimated that cotton uses approximately 9% of the world's agrochemical pesticides, about 20% of the world's insecticides and 8% of the world's chemical fertilizers. The amounts of chemicals needed to grow cotton affect human health and the world's eco-system.

In the early 1900s, cotton insect pests were controlled primarily through cultural and physical methods. Insecticides have become an integral part of the cotton production systems in the world. More than 90% of total world cotton area is treated with one or more insecticide applications per season. The major chemical classes presently in use¹⁴ are relatively inexpensive and broad-spectrum. They are, however, significantly disruptive to most beneficial

11 Ring spun carded yarn is typically used for knitting and weaving, in a large range of coarse to fine counts.

12 Combed yarns are stronger, more uniform, smoother, purer and have greater shine than carded yarns.

13 Pesticides including insecticides, fungicides and nematicides, herbicides and nutrients, including nitrogen fertilizers.

14 Organophosphates, carbamates and synthetic pyrethroids.

insects and they have significant environmental residue problems. Insect resistance to insecticides is the major problem affecting agrochemical usage on cotton. Herbicide resistance is also becoming a problem.

The use of water resources in cotton farming presents a significant environmental challenge. Irrigated cotton is frequently grown in regions where fresh water is in short supply, such as the Mediterranean and desert or near-desert areas in Australia, India, Pakistan, Uzbekistan, and west United States. Extensive irrigation of cotton affects regional water resources and ecosystems, possibly contributing to surface and groundwater depletion. Inadequate drainage has contributed to the salinization of fresh water in China, Egypt and Uzbekistan. Fertilization practices increase the risk of erosion, and diffusion of residues of synthetic fertilizer increase the risk of contamination of surface and groundwater.

Current production technology affects the sustainability of cotton production worldwide. The solution lies in developing alternative approaches, which are less dangerous to human health and the environment. The success of cotton production depends on the least use of chemicals, and the best use of available resources such as water and soil.

Organic cotton

Organic cotton production and trade is promoted as a more viable and sustainable alternative to conventional cotton production. However, farmers generally do not adopt new production techniques unless they are profitable. Organic seed cotton yields tend to be lower than conventional ones, and even lower than what might be acceptable in view of lower production costs. Nevertheless, some consumers are willing to pay a premium for textiles and clothing made out of certified organic cotton fibre, and labelled as such. Although production of organic cotton is expanding rapidly, conventional cotton still accounts for about 99.9% of total world output.

Biotech cotton

The biotech cotton in commercial use today has been genetically engineered to be tolerant to herbicides or insect resistant. Of the types of transgenes currently available for commercial production in cotton, two provide tolerance to herbicides and one is resistant to bollworms (Bt, from *Bacillus thuringiensis*). *Bacillus thuringiensis* is a very common bacterium occurring in the soil and capable of producing 'cry' proteins. The 'cry' proteins are toxic to certain types of insects (e.g. moths such as bollworms) that attack cotton, and the action is specific to those insects. The target insect must ingest the *Bacillus thuringiensis* 'cry' protein for the protein to be effective.

Bt cotton was first planted on a commercial scale in 1996 in Australia and the United States. 'Stacked' gene varieties having herbicide resistance and the Bt gene were introduced in 1997. Biotech cotton has been officially approved for commercial release in nine countries (Argentina, Australia, China, Colombia, India, Indonesia, Mexico, South Africa, United States) and experimentation is under way in several other countries, notably in Burkina Faso. Monsanto has a dominant position and controls about 80% of commercial biotech cotton.

The first generation of Bt cotton (Bollgard I) was designed to eliminate the need to spray pesticides to control boll weevil infestations. The second generation of Bollgard technology is intended to suppress damage by other pests and the need for supplemental spraying that was commonly needed for the first generation varieties.

Farming with biotech cotton has an immediate positive effect on the environment. Cotton requires more pesticide use than any other crop, and all of the new biotech varieties are designed to reduce the use of pesticides that are harmful to human and environmental health.

Biotech cotton is genetically modified to produce a toxin that kills certain insects or resists certain herbicides, not to increase yields. Claims made about the ability of biotech cotton to increase yields relate to its capacity to reduce damage caused by insects or weeds. As a result of the adoption of insect-resistant cotton, the number of insecticide applications and the quantity of insecticide used per hectare of cotton have decreased. However, farmers still have to spray for non-target insects that are not controlled by biotech cotton.

The major disadvantage of biotech cotton is the relatively high cost of the seed and technology fee. The commercialization of biotech products requires a long process of regulatory approval. Countries have to pay a technology fee to owners of the genes, and this is limiting the adoption of the technology, particularly in developing countries. Because a private company owns the genes inserted into cotton, countries are legally bound not to insert the genes into their own varieties and start using them.

The economic benefits of biotech cotton depend on whether the increase in yields and the reduction in chemical application cost outweigh the higher seed cost.

Genetic modification is a new technique that is far from fully understood and the impacts on the environment and human health could take years to appear. One of the major concerns with Bt cotton is that target pests could rapidly develop resistance to the toxin, leading to increased pest problems. In the absence of a clearly defined resistance management strategy that involves planting non-Bt cotton 'refuge' areas, some cotton pests are likely to develop resistance to Bt cotton. The potential emergence of resistance to Bt among insects threatens the long-term viability of Bt cotton. There is also potential for harmful environmental impacts. The use of those herbicides that biotech cotton is designed to tolerate will undoubtedly increase. Foreign genes introduced into the cotton may be transferred from the biotech cotton to related wild species and conventional cotton being grown nearby. Once a transgene is introduced into the environment, it would be difficult if not impossible to remove it if harmful effects for human or environmental health were discovered. Gene flow could occur between Bt cotton and local varieties or wild species of cotton, thereby jeopardizing these reserves of biodiversity; and contamination by biotech cotton could compromise the entire production of organic cotton in a region, since organic certification criteria prohibit genetically modified organisms. Consumers may wish to avoid biotech products because of ethical or safety concerns although there are, at the moment, no provisions for labelling in textiles or in cottonseed oil.

ICAC estimates that biotech cotton accounted for over 40% of world production and world exports in 2006/07.

Coloured cotton

Cotton occurs naturally in four colours: white (creamy to bright), brown (light brown to mahogany), green (light green to green) and blue (very light). Some genotypes may show colour fading with time and washing, while others may not. Brown colour in some genotypes may intensify after many washings. Coloured lint usually has poor quality: the fibre is weak, it has higher micronaire and it is shorter in length. The market for coloured cotton is a niche market.

Extra long staple cotton

The term ‘extra long staple’ (ELS) cotton typically denotes a cotton fibre of extraordinary fibre length. The recognized industry standard for the minimum fibre length of an ELS fibre is 1-3/8" or 34.925 mm. This minimum is significantly longer than traditional varieties of cotton, known as Upland cottons, where the staple length can average 26–27 mm. ELS varieties, by comparison, can see fibre lengths exceed 40 mm at the top end. A comparison of the fibre lengths of Upland cottons and ELS cottons can be seen in figure 5.1, which uses data for American cottons obtained from USDA. The graph is represented in terms of percentages as the different bale volumes of Upland cotton and ELS cottons in the United States do not yield a valuable visual data set.

As well as fibre length, ELS cottons are also recognized for their superior strength and better uniformity. Figure 5.2 shows an example of a typical strength comparison between an Upland cotton and an ELS cotton.

However, even with all the benefits of the ELS fibre characteristics and its apparent desirability, it is grown only in limited quantities. ELS and LS (long staple) cottons represent only about 3% of the entire world’s cotton production. The ELS cotton varieties are specific in their needs to produce a successful crop. A significant amount of crop management is required for ELS cottons, above and beyond that of Upland cottons. ELS cottons tend to be very vigorous plants and if not managed will grow to be large plants with minimal fibre production. Also, the relative yield of ELS cottons is never as high as their Upland cotton counterparts. Environmental conditions for ELS cottons are specific: they can be grown only in the limited areas that suit the plant’s needs for hot days and cool nights. All of these factors result in higher production costs, with increased risks compared to Upland cotton. This in turn is a major limiting factor for the production of ELS cottons.

ELS cottons have found their way into specialty products with appropriate price margins to absorb the additional production costs. An original ELS variety that was grown in the Caribbean and the United States during the 1600s and 1700s was known as Sea Island cotton in recognition of the island where it was produced – Sea Island, Georgia, United States. Other names have also been generically associated with ELS cottons. The name Pima is generally applied in the global marketplace to identify products that are purportedly made with ELS

Figure 5.1: Comparison of lengths of Upland and ELS cottons

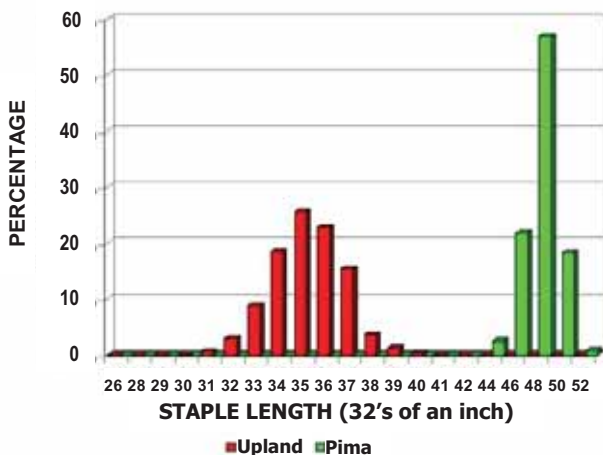
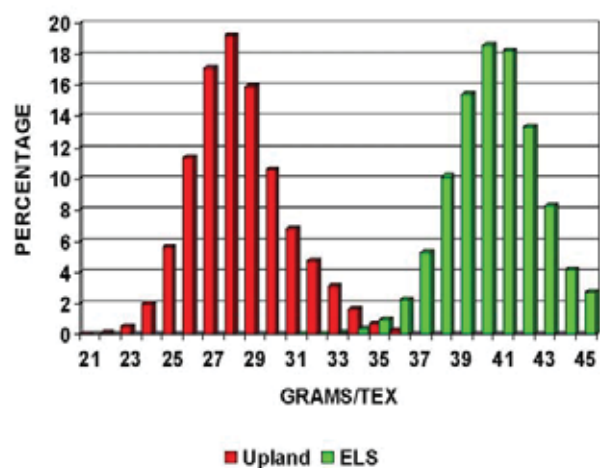

Figure 5.2: Comparison of strength of Upland and ELS cottons



cottons. The Pima name itself comes from the United States: USDA gave the Pima name to the ELS cotton that it was breeding in Sacaton, Arizona, in recognition of the Pima Indians who were instrumental in growing the cottons and running the field trials. The Pima name is now used by other ELS producing nations such as Peru, Australia and Israel. The name Egyptian cotton is also broadly recognized as being associated with quality products. However, only a smaller percentage of Egyptian cotton produced each year is actually ELS cotton. The majority of Egyptian production is a long staple cotton variety called Giza 86. Unfortunately, the name of Egyptian cotton has been unable to maintain its high status level because of a variety of products that are made with Egyptian cotton but are most often not made with the finest cottons from Egypt. A similar thing has happened with the Pima name: it has not been controlled or managed to protect its value and market position as a premium product. As ELS cottons account only for about 3% of global cotton production, Pima's position in the product marketplace should stand in the top 3% of home textiles and apparel products. In order to maintain and expand ELS production, the value of the fibre needs to be maintained by protecting and promoting its uniqueness and by putting it into products that can feature and highlight the superior fibre.

ELS cotton production

During the 2006/07 crop year it is estimated that China became the largest producer of ELS cotton in the world, with 781,000 bales of production compared to United States production of 765,400 bales. A surge in plantings saw an increase that more than doubled production levels from the previous year's 367,000 bales. China is expected to increase production again for the 2007/08 crop, albeit by a far slimmer margin this time around, to about 811,000 bales. The United States is now the second-largest producer of ELS cotton, having previously been the largest. Production in the United States has grown on a much slower and more consistent long-term basis than the growth witnessed in China recently. The next largest producers of ELS cottons are India and Egypt. ELS cottons are also grown in lesser quantities in Sudan, the Commonwealth of Independent States (including Tajikistan, Turkmenistan and Uzbekistan), Australia, Israel and Peru.

ICAC tracks and publishes statistics on supply of and demand data for cotton, including a report called *Extra-Fine Cotton This Month*. The report from 14 June 2007 forecasts an ELS and LS production figure for the 2007/08 crop year of 3,520,000 bales. This is an increase over the previous year, and almost as large as the previous recent largest production years of 2001/02 and 1993/94. This production estimate is also over 900,000 bales higher than the figure two years ago. When looking only at the ELS component, global production is estimated to be 2,652,000 bales for 2007/08. This is an increase of 775,000 bales over the production figure from two years ago. Almost 60% of that increase can be contributed to the growth in China's production.

ELS cotton exports

As production increases, the consumption of ELS cotton becomes ever more important. Globally, consumption of ELS and LS cottons has grown, and annual ending stocks have shrunk from about 1,800,000 bales in the 1993/94 crop year to 945,000 bales in the 2006/07 crop year. However, the consumption of ELS and LS cottons is not simply tied to the consumption of this cotton by spinning mills. As noted previously, the consumption of the cotton is innately tied to the selection of this specialty fibre by brands and retailers for use in better quality cotton products. This reinforces the importance of maintaining a clear name and image for these unique fibres as a special product that produces premier quality products.

Most of the ELS and LS producing nations are also the main consumers of ELS and LS cottons. The only real exception to this is the United States. The United States is the largest exporter of ELS cottons and, according to ICAC data, accounts for about 45% of the total ELS and LS exports on an annual basis. American Pima exports account for approximately 90% of annual production. This has arisen because of the shrinking domestic textile industry in the United States. By comparison, many of the other ELS and LS producing nations have larger and more robust domestic textile industries to use the fibre domestically. Exports of American Pima cotton also benefit from its high quality and consistency and recognition of its low levels of contamination, along with the benefits associated with the third-party classing of every bale grown in the United States by the USDA.

ELS cotton consumption

The largest consumer of ELS cottons is China, closely followed by India. These two nations account for approximately 85% of the world's ELS consumption. The remaining consumption is distributed around the rest of the world.

American ELS Competitiveness Payment Program

The American Extra Long Staple (ELS) cotton programme includes a competitiveness provision designed to ensure that American Pima cotton can be readily marketed in both the domestic and international markets. The programme operates when American Pima prices are above world prices for a certain period and provides a payment to eligible domestic users and exporters of American ELS cotton in the amount of the difference between the United States and world prices.

Since 5 August 2005, the ELS payment rate is determined by the difference between the CNF Far East American Pima quotation and the lowest foreign ELS quotation adjusted for quality, as reported by Cotton Outlook. Payments continue as long as the weekly average for the lowest adjusted foreign growth quote (LFQ) remains below the weekly average quotation for American Pima, and the LFQ is less than 134% of the American Pima base grade loan value (currently 82.25 cents per pound).

The ELS Competitiveness Payment Program is similar to the Step 2 of the 3-step competitiveness programme for American Upland cotton. Following the dispute brought by the Government of Brazil against American Upland cotton subsidies in 2003, the World Trade Organization (WTO) ruled in 2005 that the Step 2 payments to exporters of cotton were prohibited export subsidies, and Step 2 payments to domestic users were prohibited import substitution subsidies because they were only made for American cotton. Competitiveness payments for Pima cotton continue despite the elimination of Step 2 payments for American Upland cotton on 1 August 2006.

ELS cotton flourishes in niche markets

ELS cottons, because of their fibre characteristics, were originally used extensively in home textile products and in luxury apparel wear such as fine dress shirting. However, awareness of the ELS fibre qualities has grown and ELS cotton is being used in an increasing variety of products because of the superior feel, quality and durability of the finished products. ELS cottons have a natural sheen and yield a product with a soft feel that the consumer prefers. Today ELS cottons are found in traditional home textile products such as sheets and towels, as well as in blankets, duvets and bath mats for example. The use of ELS cottons in the apparel market has grown very rapidly, with ELS cottons now being used in virtually any apparel product that has been made with cotton. Today's leading designers are using ELS cottons to create unique and special products, and to update existing products or mainstream lines.

Organic cotton: an opportunity for trade¹⁵

Organic cotton

Organic cotton is cotton that originates from organic agriculture. Agricultural production is considered ‘organic’ when it has been certified ‘organic’ by independent inspection and certification bodies according to the rules and regulations that apply in that particular country, region, or envisaged consumer market.

The International Federation of Organic Agriculture Movements (IFOAM), which is the representative body for organic agriculture worldwide, defines ‘organic agriculture’ according to four principles:¹⁶

- ❑ *The principle of health.* Organic agriculture should sustain and enhance the health of soil, plant, animal, human and planet as one and indivisible.
- ❑ *The principle of ecology.* Organic agriculture should be based on living ecological systems and cycles, work with them, emulate them and help sustain them.
- ❑ *The principle of fairness.* Organic agriculture should build on relationships that ensure fairness with regard to the common environment and life opportunities.
- ❑ *The principle of care.* Organic agriculture should be managed in a precautionary and responsible manner to protect the health and well-being of current and future generations and the environment.

In general, organic agriculture aims for an optimum and sustainable use of local natural resources for production without the application of external inputs like synthetic pesticides, chemical fertilizers, herbicides, defoliants and chemically treated or genetically modified (GM) seed. External ‘organic’ inputs may be used.

Farmers wishing to convert to organic agriculture will have to go through a conversion period of one to three years, depending on their fields’ history. The conversion period enables the soil and the environment to recover from previous cultivation, while applying organic methods of production. The ‘in-conversion’ produce cannot be sold as ‘organic’, and does not usually fetch a premium in the market. The risks and costs of conversion are a major barrier to the adoption of organic agriculture.

Organic production is generally more labour intensive, and yields may be – but are not necessarily – lower than in conventional production. Organic farmers usually fetch a premium for their produce in order to compensate for any yield loss, for increased handling operations and for additional costs such as inspection and certification. The premium may also be paid in order to ensure the loyalty of producers to the organic scheme.

15 A more detailed technical paper with the same title, written by Peter Ton, is available from ITC upon request.

16 IFOAM is in the process of establishing a full definition of ‘organic agriculture’; expected in 2008. For the four guiding principles see www.ifoam.org/about_ifoam/principles.

Standards

The European Union (EU regulation 2092/91),¹⁷ the United States (NOP)¹⁸ and Japan (JAS), among others, protect the use of the word ‘organic’ on food and processed food for sale. These regulations apply to products deriving from agriculture and animal husbandry, but not to products like fish or to non-food items such as cotton products. There are thus no particular legal requirements for the import and sale of organic cotton and organic cotton products in the main consumer markets in the North, other than those for conventional cotton.

However, in order to distinguish cotton originating from certified organic farms from conventional cotton, market players will consider cotton ‘organic’ only if the seed cotton was produced on certified organic farms and processed in certified organic ginning mills. Certification by third parties is generally requested in order to back up producers’ organic claims, and to strengthen trust between the supplier and the buyer.

Organic seed cotton and cotton fibre¹⁹ should be treated separately from conventional seed cotton and cotton fibre at any time; whether on the field, at storage in the village, on transport to the ginnery, during ginning, during storage at the ginnery or port, or during transport to the textile processing unit. The separate treatment should be duly documented and archived for the purpose of inspection and certification by a third party. Buyers will usually request a ‘transaction certificate’ from a third party to ensure that the cotton fibre traded was produced according to organic standards.

Standard-setting for the processing and trade of organic cotton fibre results from private initiative. The lack of regulatory back-up by governmental policy can be considered a weak element of the current organization of the organic cotton sector. This was grounds, for example, for IFOAM to call upon the European Union (EU) to include organic textiles in the 2006 revision of the EU organic regulatory framework (IFOAM, 2005).

Requirements for processing

Private standards have also been developed for the environment-friendly processing of organic cotton fibre into yarn, fabric and garments. Many different voluntary standards for the ecological processing of organic cotton and textiles were developed, among others by the following control and certification agencies: Control Union/Skal (Netherlands), Organic Trade Association (OTA) (United States), Internationaler Verband der Naturtextilwirtschaft (IVN) (Germany), Soil Association (United Kingdom), Japan Organic Cotton Association (JOCA) (Japan) and Naturland (Germany). Individual companies may also have their standards for the ecological processing of their 100% organic cotton textiles and clothing.²⁰

Global harmonization of organic textile standards is underway. Global Organic Textile Standards (GOTS) have been developed recently by the certifying bodies IVN, JOCA, Soil Association and OTA.²¹ Other certifiers are expected to join the GOTS initiative, which was launched on 1 October 2006. The harmonized standard aims to ensure the organic status of textiles, from harvesting of the raw materials, through environmentally and socially

17 For an explanation of the EU regulatory framework for organic agriculture, see http://ec.europa.eu/agriculture/qual/organic/brochure/abio_en.pdf.

18 For the USDA National Organic Program (NOP), see www.ams.usda.gov/nop/NOP/standards.html.

19 Cottonseed has much lower value (10%–15% of seed cotton value) than cotton fibre (85%–90%). The organic cottonseed resulting after ginning (about 55% of seed cotton weight) can also be traded as organic, for example for use as animal feed in the organic dairy industry.

20 Examples are Remei (Switzerland; bioRe label) and OTTO (Germany; Pure Wear label).

21 The Global Organic Textile Standards are summarized at www.global-standard.org.

responsible manufacturing up to labelling, in order to provide credible assurance to the end-consumer. GOTS enables textile manufacturers to qualify their organic fabrics and garments with one certificate accepted in all major world markets, which is an important step towards harmonization and transparency of textile labels (IMO, 2006).

The organic cotton business network Organic Exchange has established standards for textile certification which do not require all cotton used to be organic. The Organic Exchange Blended Standard (2005)²² relates to the tracking and tracing of certified organic cotton fibre that is blended into conventional textiles, for example at a rate of 5% organic cotton with 95% other fibres (conventional cotton, synthetic fibres, wool, etc.).

Finally, there are a number of public and private labelling schemes that consider the sustainability of textile processing from the angle of consumer safety and the allergenicity of textiles and clothing. Examples are the EU Flower eco-label for textiles and schemes such as Oeko-Tex 100 which ensure low levels of chemical residues in end-products.²³ These schemes, however, do not require the use of organic cotton fibre.

'Fair trade' cotton

'Fair trade' is promoted by a wide array of organizations internationally. In 2001 the four umbrella organizations for fair trade initiatives agreed upon the following definition of 'fair trade': *'Fair trade is a trading partnership, based on dialogue, transparency and respect, that seeks greater equity in international trade. It contributes to sustainable development by offering better trading conditions to, and securing the rights of, marginalized producers and workers – especially in the South. Fair trade organizations (backed by consumers) are actively engaged in supporting producers, in awareness raising and in campaigning for changes in the rules and practices of conventional international trade.'* (Krier, 2005.)

Fair trade's strategic intent is *'to deliberately work with marginalized producers and workers in order to help them move from a position of vulnerability to security and economic self-sufficiency, to empower producers and workers as stakeholders in their own organizations, and to actively play a wider role in the global area to achieve greater equity in international trade'* (Krier, 2005).

Textiles and clothing made of fair trade cotton have been for sale in several European countries since 2005. This 'fair trade' cotton is produced by farmers whose producer organizations have been certified according to the standards of Fairtrade Labelling Organizations International (FLO), one of the four umbrella organizations referred to above. FLO is the leading 'fair trade' standard setting and certification body.

FLO works with labelling initiatives in 15 European countries as well as Australia and New Zealand, Canada, Japan, Mexico and the United States. FLO regularly inspects and certifies about 500 producer organizations in more than 50 countries in Africa, Asia and Latin America. Producers from countries in Europe, the United States and Turkey, among others, are not currently eligible to sell under fair trade.

Fair trade favours the transparent management of producer organizations and the empowerment of producers. Fair trade cotton contributes to higher producer income and to poverty reduction.

22 The OE Blended Standard 2005 is available at www.organicexchange.org.

23 For a brief comparison of the EU Flower scheme and the Oeko-Tex scheme, see www.eco-forum.dk/textile-purchase/index_files/Page2303.htm.

Standards

Smallholders participate in fair trade through membership-based producer organizations (cooperatives, producer groups, associations, etc.). FLO controls and verifies these organizations according to two sets of standards: generic standards and product standards.²⁴ The generic standards aim to ensure transparency in management of the producer organizations. Progress requirements are used in addition to encourage producers to continuously improve their livelihoods and organization (FLO, 2005).

Product standards now exist for bananas, cane sugar, cocoa, coffee, dried fruit, flowers, fresh fruits and vegetables, fruit juices, herbs and spices, honey, nuts and oilseeds, quinoa, rice, seed cotton, sport balls, tea and wine grapes. The product standards for seed cotton were established in 2004 and revised in 2006 (FLO, 2006a). There are no standards yet for the processing and trade of fair trade cotton throughout the cotton textile production chain. Generic standards for traders are under development.

Fair trade is based on paying producers a guaranteed minimum price. The minimum price should be high enough to cover the costs of production and the producer's costs of living, plus the costs of control and certification by the inspection body FLO-Cert which certifies against the fair trade standards established by FLO. In addition to the minimum producer price, a communal premium is paid to the producer organization for investment in projects that have been collectively decided upon by its members.

The product standards for fair trade cotton caution producers about pesticide use. FLO works with a list of prohibited materials which includes a number of pesticides that are in use in conventional cotton production in some countries, such as the insecticides endosulfan, methamidophos, monocrotophos and triazophos, and the fungicides lindane and paraquat (FLO, 2006b). The prohibition of these highly toxic pesticides reduces the hazards of pesticide poisoning and food contamination. FLO further encourages producers and their organizations to reduce their overall pesticide use through integrated pest management (IPM) strategies.

Development of fair trade cotton

FLO works with a guaranteed minimum price for producers that varies according to the production context of each country. In West Africa, the minimum price was fixed at FCFA 238 per kg of seed cotton (EUR 0.36 per kg; i.e. 43 US cents per kg, or 20 US cents per pound), which is well above the local conventional price. For example, in Burkina Faso and in Mali the conventional price was FCFA 210 per kg in 2004/05, and FCFA 175 in Burkina Faso and FCFA 160 in Mali in 2005/06. The producer price of the fair trade cotton was thus 13% higher than for conventional cotton in 2004/05, 36% higher in Burkina Faso in 2005/06, and 49% higher in Mali in 2005/06. A communal premium price of FCFA 34 per kg of seed cotton was paid as well, after sale of the fibre.

The higher price of fair trade cotton must be put in context though. Firstly, the producer price also covers the costs of registration, inspection and certification by FLO-Cert. Secondly, the producers in West Africa agreed to select their seed

24 The FLO generic standards for smallholder farmers' organizations and the FLO standards for seed cotton for smallholder farmers' organizations are available at: www.fairtrade.net/standards.html.

cotton more thoroughly at harvest in order to ensure quality.²⁵ They sold seed cotton of a higher value to the ginning and trading companies than in conventional trade. Thirdly, the producers receive the communal premium only for the cotton fibre quantities that have actually been sold by the buyer in the marketplace as fair trade cotton.

Fair trade cotton, certified by FLO-Cert, is in its third year of existence. In 2006 there were eight FLO-certified groups in six countries: Burkina Faso, Cameroon, India, Mali, Peru and Senegal. In 2005, the first season of sale, trade in FLO-certified cotton involved 1,400 tons, half of which went to France and half to Switzerland. Since then, sale of fair trade cotton products has extended to Austria, Belgium, Luxembourg and the United Kingdom. Sales will be launched in the Netherlands in 2007. Germany and the United States may follow suit. Sales in 2006 were approximately 4,000 tons of cotton fibre.

Actors currently involved in the processing and distribution of fair trade cotton include a variety of textile and clothing producers selling, among others, socks, T-shirts, polo shirts, household textiles, and cotton products for cosmetics. Distribution channels include mail order, department stores, independent shops and specialized boutiques.

Organic and fair trade

FLO does not require fair trade cotton to be produced organically. However, the produce may well be certified organic. Market actors are increasingly looking for 'organic fair trade' cotton when developing policies of corporate social responsibility (CSR). Consumers of textiles and clothing do not want products to be just organic or fair trade; they want them to be both.

The FLO standards prescribe the level of the additional premium that is paid for certified organic produce. In West Africa, the organic premium is FCFA 34 per kg of cotton (EUR 0.05 per kg; i.e. 6 US cents per kg, or 2.7 US cents per pound). A minor part of the FLO-certified fair trade cotton is currently certified organic.

The organic cotton market

The history of organic cotton production

The certified production and consumption of organic cotton dates back to the early 1990s, when pioneers in the United States and Turkey started to create markets for cotton that was grown as a rotational crop on certified organic farms. The first organic cotton textiles brought to the market consisted of a limited range of 100% certified organic cotton products, which were sold in a small number of dedicated shops – usually natural and health food stores. They were primarily marketed for their ecological characteristics, rather than for their quality, design or fashionable appeal.

Trends in the 1990s

In late 1992, some environmentally motivated textile and clothing designers and companies launched the sale of more fashionable ecological textiles, later known as the 'eco-look' in fashion. Ecological textiles were now also for sale in fashionable shops such as Esprit and Hennes & Mauritz (H&M), in addition to the continuing sales in health food and natural textile shops. Products on offer

²⁵ This is not a formal requirement of FLO, but was rather the result of a voluntary agreement between the buyer, the French group Dagrís, and the fair trade cotton producers in West Africa.

tended to be either 'ecru' or dyed with soft 'natural' colours. Environmental awareness about fibre, textile and clothing production was created among consumers and in the industry. However, there was also confusion about the value of the different environmental claims found in the marketplace (e.g. 'natural' or '100% hand-picked cotton'²⁶). The eco-look lasted till late 1994, when fashion turned towards the use of bright colours and synthetic fibres.

The design, quality and colour range of organic cotton items improved significantly in the second part of the 1990s. The range of yarns and fabrics available expanded, which widened the offer and the quality of the organic cotton textiles and clothing for sale. Supply of organic cotton fibre was in excess though, while overall demand stagnated. Several large United States-based companies involved in organic cotton usage at the time, such as Levi's and the Gap, withdrew from organic cotton use.

Overall, global demand for organic cotton remained more or less stable up until 2000. Most demand came from Europe, particularly from Germany thanks to mail order companies such as OTTO and Hess Natur, and to a large number of small and medium-sized companies processing and selling 'natural textiles' including organic cotton items. In Switzerland, the supermarket chain Coop ensured a steady and increasing demand for organic cotton from 1995. By 2000, this example was being followed by its main, larger, Swiss competitor Migros. Demand in the United States and the United Kingdom relied in this period primarily on mail order catalogues and also on early electronic commerce.

Mail order catalogues were (and are) also very important in Germany. Catalogues are a good medium to tell the 'organic cotton story' to geographically dispersed consumers in a small and newly emerging market. Around 2000, however, the German market for organic cotton textiles and clothing was in difficulties because of a mail order crisis, affecting companies such as Hess Natur (Germany), Köppel (Switzerland) and Waschbär (Germany). Many specialized natural textile shops had to close down. The decrease in consumer demand was probably related to issues concerning the design, quality and fit of the organic cotton items on offer. Design, fit, colour and price are all major elements of consumer choice for textiles and clothing. Environment and 'organics' are at best an additional positive feature.

Trends between 2000 and 2005

By 2000, new strategies were required to increase organic cotton demand and subsequently production. In the United States, large companies operating internationally became increasingly concerned about the value of their brand and image, following public concern about social issues such as child labour and the working conditions in sweatshops. Some brands became aware that involvement in organics might help them to increase or restore their brand value and image.

They were not keen though on paying significantly more to farmers for certified organic cotton than for conventional cotton. Supplying large brands would also require fibre volumes which were enormous for the newly emerging organic cotton market. Furthermore, organic cotton actors (in the United States in particular) were aware that the provision of large volumes of fibre to only a few large companies would generate a high level of dependency and risk.

26 All cotton originates from vegetative production. Mechanical picking is generally limited to high-producing, capital-intensive production (e.g. United States, Australia).

A solution was found in the development of so-called blending programmes, in which brands engage in the use of a small percentage of organic cotton fibre (for example starting with 3%–5%) in their products. At the spinning mill, the organic cotton fibre is mixed into conventional cotton yarn or into other yarn types. Thanks to blending, the costs of using higher-priced organic cotton could be limited as a percentage of product value. Organic cotton usage per company was intended to gradually increase over time, along with supply.

This United States-developed model for growth in organic cotton usage proved successful for a number of brands. The sports brand Nike, in particular, gradually increased its organic cotton usage from 2000 on, making it the global leader in organic cotton fibre usage in 2005. Nike also succeeded, together with Patagonia, in interesting brands such as Timberland, Marks & Spencer and Nordstrom in conversion programmes using 5% organic cotton.

By 2006, many large and medium-sized textile and clothing companies had followed the example of Nike and others, and launched organic cotton conversion programmes. The organic cotton business network Organic Exchange has been instrumental in that process since its foundation in 2002. According to Organic Exchange, there are now at least 35 companies running organic cotton conversion programmes, plus an additional 2,000 smaller brands and initiatives using organic cotton around the globe (Calahan Klein, 2006).

The demand for organic cotton is increasing rapidly, with 100% organic cotton items now showing up in regular fashion fairs such as Magic (United States), Première Vision (France) and the London Fashion Week (United Kingdom). Organic cotton textiles and clothing are now for sale at top locations in high-end fashion streets, in addition to other distribution channels such as supermarkets, natural and health food stores, specialized boutiques, mail order, and electronic commerce.

Organic cotton production

Reliable data about the production, trade and consumption of organic cotton are difficult to establish. Independent data from third-party certifiers are not available for reasons of commercial confidentiality. Differences between the declared and the real volumes of traded organic fibre can be significant.

The data presented in this chapter stem from a variety of sources, including documentary and Internet research, interviews and electronic contacts with about 130 actors in the organic cotton textile chain, attendance at trade fairs for cotton and textiles, and participation in the 2006 conference of the organic cotton business network Organic Exchange. The data presented are based on self-declarations and claims of projects and companies, and on additional 'best guesses' by the author.

Today, certified organic cotton is grown in 22 countries in the world (see table 5.1).²⁷ Total production of and trade in organic cotton fibre is estimated at 23,000 tons in 2006.²⁸ Earlier estimates in 2001 and 2004 amounted to 6,000–6,500 tons and 10,000 tons of fibre respectively (Ton, 2002; Ton, 2005). Production growth was an annual 70% over the period 2001–2006, and has reached 120% per year since 2004. Despite this spectacular growth, the volume of organic fibre traded on the international market still represents only 0.09% of the 24.8 million tons of cotton fibre traded worldwide.

27 Four countries are expected to join in 2006/07: Malawi, Mozambique, the Syrian Arab Republic and Viet Nam.

28 The organic cotton business network Organic Exchange gives a much higher estimate of 31,000 tons (Ferrigno, 2006), while overestimating 2006 production in India and Africa.

Table 5.1 Organic cotton production and trade worldwide (in tons of fibre, 1990–2006)^{a)}

Country	1990/91	1991/92	1992/93	1993/94	1994/95	1995/96	1996/97	1997/98	1998/99	1999/00	2000/01	2004	2006
Argentina	-	-	-	-	75	75	-	-	-	-	-	-	-
Australia	n/a	n/a	479	500	750	400	300	300	-	-	-	-	100
Brazil	-	-	-	2	8	1	1	1	3	12	18	20	8
Benin	-	-	-	-	-	-	2	4	15	19	30	80	47
Burkina Faso	-	-	-	-	-	-	-	-	-	-	-	-	61
China	-	-	-	-	-	-	-	-	-	-	-	1,787	1,750
Egypt	-	11	38	140	598	650	630	500	350	200	200	200	240
Greece	-	-	-	-	308	161	128	110	75	50	50	50	-
India	-	-	206	268	393	934	850	1,000	825	1,150	1,000	2,050	6,500
Israel	-	-	-	-	-	50	50	20	140	180	530	380	400
Kenya	-	-	-	-	-	-	-	5	5	7	-	-	6
Kyrgyzstan	-	-	-	-	-	-	-	-	-	-	-	-	60
Mali	-	-	-	-	-	-	-	-	-	-	-	34	160
Mozambique	-	-	-	-	-	90	75	50	-	-	-	-	-
Nicaragua	-	-	-	-	16	20	20	20	-	-	-	-	7
Pakistan	-	-	-	-	-	-	-	-	-	-	-	-	100
Paraguay	-	-	-	100	75	50	50	50	-	-	-	60	75
Peru	-	-	200	685	894	900	600	650	650	500	559	500	750
Senegal	-	-	-	-	-	2	11	14	54	122	208	20	20
South Africa	-	-	-	-	-	-	-	-	-	-	-	-	5
Tanzania, United Republic of	-	-	-	-	-	8	102	96	111	192	187	368	660
Turkey	5	60	120	198	610	720	850	1,000	1,200	2,000	1,750	2,000	10,000
Uganda	-	-	-	-	22	74	291	455	244	187	287	765	600
United States	n/a	n/a	977	1,938	2,433	3,367	1,540	1,293	1,956	2,916	1,624	1,100	1,500
Zambia	-	-	-	-	-	-	-	-	-	-	-	-	4
Zimbabwe	-	-	-	-	-	-	-	2	5	3	-	-	-
Subtotal	5	71	2,020	3,831	6,182	7,502	5,500	5,569	5,633	7,538	6,443	9,414	23,053

Source: Elaborated by P. Ton, based on a variety of sources.

^{a)} The data in this table relate to the volumes of fibre that are estimated to have been traded as 'certified organic' up to the level of spinning. Most country figures, particularly those for the largest producing countries, rely on estimates of varying quality.

Figure 5.3: Organic cotton production and trade worldwide (in tons of fibre, 1992–2006)

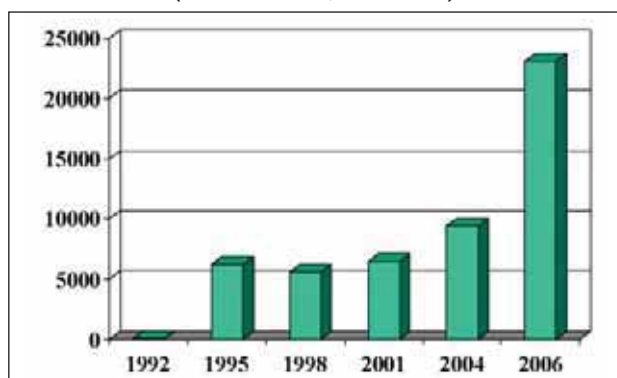
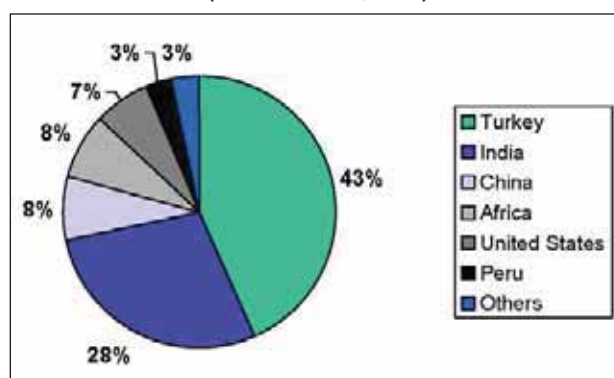

Figure 5.4: Organic cotton production and trade per production area (in tons of fibre, 2006)



Organic cotton production is concentrated in Turkey (10,000 tons of fibre; 43% of total production) and India (6,500 tons of fibre; 28%), where growth has recently also been most spectacular. Together they now produce more than 70% of the world organic cotton supply. Other relevant producers in terms of volume are China (1,750 tons; 8%) and the United States (1,500 tons; 7%). The African countries together accounted for about 1,800 tons of fibre in 2006, or 8% of total production, mainly in Uganda and the United Republic of Tanzania,²⁹ but also in Egypt and in French-speaking West Africa (Mali, Burkina Faso, Benin). Countries that recently started or restarted organic cotton production are Australia, Burkina Faso, Kenya, Kyrgyzstan, Nicaragua, Pakistan, South Africa and Zambia.

It should be noted that more than half of the global production of organic cotton fibre is in the hands of two single organic cotton projects. The largest organic cotton producer in the world is Mavideniz in Eastern Turkey, with a claimed 8,000 tons of cotton fibre in 2006, thus accounting for 80% of Turkish production, and for 35% of global production. The second-largest organic cotton producer is Eco-Farms in Maharashtra, India, with a claimed 4,000 tons of cotton fibre in 2006. Eco-Farms plans to expand production to 6,000–7,000 tons of fibre in 2007.

This high concentration of production in two single projects points to the vulnerability of the supply of organic cotton fibre. The performance of these two projects in terms of quality, price, reliability of supply, control and certification, and transparency, may determine the future of the global organic cotton market in the short and medium term.

Organic cotton consumption

The number of large textile and clothing companies involved in eco-textile sales is steadily increasing as are the volumes they purchase. Today, there are around 20 companies using more than 100 tons of organic cotton fibre per year (see table 5.2). Two-thirds of these companies started selling organic cotton textiles and clothing only after 2002. New brands entering the market along with established brands are responsible for the growth of the international market for organic cotton fibre.

²⁹ In 2006, production in Uganda and the United Republic of Tanzania suffered from severe drought, halving cotton fibre output. Some United States growers also had severe losses due to drought.

Company	Country	1998	1999	2000	2001	2004	2006
American Apparel	United States	–	–	–	–	n/a	100
Avanti Inc.	Japan	n/a	n/a	n/a	n/a	n/a	150
C&A	Netherlands	–	–	–	–	–	50
Coop-Italy	Italy	–	–	–	–	50	85
Coop-Schweiz	Switzerland	400	500	500	600	1,000	1,428
Cutter & Buck	United States	–	–	–	–	150	–
Hanna Andersson	Sweden	–	–	–	–	130	250
Hennes & Mauritz	Sweden	–	–	–	–	–	50
Hess Natur	Germany	250	280	300	175	200	250
Levi's	United States	150	175	–	–	–	150
Marks & Spencer	United Kingdom	–	–	–	–	40	100
Migros	Switzerland	–	–	–	50	100	500
Monoprix	France	–	–	–	–	50	163
Mountain Equip. Coop	Canada	–	–	–	–	100	100
Next	United Kingdom	–	–	–	–	–	50
Nike	United States	113	145	362	450	1,350	3,447
Nordstrom	United States	–	–	–	–	–	50
Of The Earth	United States	–	–	–	–	330	500
OTTO-Versand	Germany	50	150	523	533	290	300
Patagonia	United States	650	650	650	650	650	650
Sam's Club	United States	–	–	–	–	86	100
Switcher	Switzerland	–	–	–	–	n/a	150
Timberland	United States	–	–	–	–	76	103
Wal-Mart	United States	–	–	–	–	–	4,535
Whole Foods	United States	n/a	n/a	n/a	n/a	n/a	150
Woolworths	South Africa	–	–	–	–	50	100
Total		1,613	1,900	2,335	2,458	4,602	13,411

Source: Elaborated by P. Ton, based on a variety of sources including CSR and sustainability reports, brochures, website information, personal communication, and estimates by author.

In 2005, the largest users of organic cotton fibre worldwide were the sportswear brand Nike and the supermarket chain Coop (Switzerland). Nike was the absolute leader in organic cotton fibre use thanks to its blending programme and to sales of 100% organic cotton items. Sales of the latter started in the United States, but most 100% items are now on offer in Europe. Nike claims to have used in 2005 a total of 4.3 million pounds of organic cotton, or 1,950 tons of fibre (Duffy, pers. comm., 21 October 2006). This is the equivalent of 4% of its cotton usage worldwide. Coop in Switzerland was second in 2005 with a claimed usage of 1,428 tons of fibre. Coop sells a wide range of organic cotton textiles and clothing in its supermarkets and department stores throughout Switzerland. More than 50% of Coop's annual cotton usage now consists of organic cotton (Coop, 2006). Well behind Nike and Coop comes the number three in terms of organic cotton usage in 2005: outdoor sportswear company Patagonia, with around 650 tons, which is 100% of its cotton usage.

The organic cotton market is very dynamic however. In late 2005, the world's largest retailer, Wal-Mart, announced its decision to expand the range of organic products it has for sale, including organic cotton items. Wal-Mart first launched the sale of organic clothing in 2005 through its United States subsidiary Sam's Club, which had great success in the sale of 100% organic yogawear. In May 2006, Wal-Mart supermarkets started to sell organic cotton babywear under the label George Baby Organic. The range of organic cotton textiles and clothing for sale will be expanded in 2007. In order to do this, Wal-Mart placed the largest order for organic cotton fibre ever in spring 2006: 10 million pounds, or about 4,500 tons of fibre. This is the equivalent of no less than 20% of the organic cotton fibre traded worldwide.

Organic cotton: an issue of large brands?

Up to 2000, the market for organic cotton and eco-textiles was shaped by a few committed and leading companies (Patagonia, OTTO, Coop, Nike, Hess Natur), together with a wide range of small and medium-sized textile and clothing companies. Since then many new brands and retailers have started an organic cotton blending or conversion programme. The number of small and medium-sized companies entering the organic cotton market has also expanded rapidly to a current estimated total of 2,000 (Calahan Klein, 2006).

Market share of the big brands and retailers had increased between 1998 and 2001 from about one-third of global organic cotton fibre volume to about one-half, under the influence of the organic cotton blending programmes (Ton, 2002). Today, the estimated market share of large brands and retailers (some 25 in total)³⁰ has increased to 58%, taking into account the new Wal-Mart involvement. The organic cotton market thus relies increasingly upon usage by big brands and retailers.

Organic cotton processing

In the 1990s, retailers wishing to offer organic cotton items for sale to consumers were faced with a lack of infrastructure. Technical challenges were still many (for example the homogeneity of quality, and access to environment-friendly dyes), and markets for higher-value organic cotton items were limited. Production runs were small and production costs per unit high. Few industries were therefore ready to set aside workers' time and production capacity for the manufacturing of organic cotton textiles and clothing

The blending programmes mentioned have helped to overcome this situation. Large brands such as Nike and Marks & Spencer started to require their suppliers to blend some percentage of organic cotton into the product. The brands did not wish to pay any premium for the blends, however, expecting the mills to absorb the additional expenses in exchange for preferential treatment by the buyer. This push by some big brands motivated many spinning and weaving mills to inquire about organic cotton, to learn about the story behind organic cotton, and to try to ensure their access to organic cotton supply. Awareness-raising of the industry was (and is) an important output of the blending model. It created the foundations for future growth.

The growing demand for organic cotton, and the significant interest from new brands, makes it possible for industries today to operate larger production runs of organic cotton textiles than before, thus reducing the cost per unit. The infrastructure for organic cotton manufacturing, including 100% organic

³⁰ 'Large' here refers to an estimated organic cotton usage in 2006 of 100 tons of fibre or more, and to large textile and clothing companies that have started with organic cotton blending programmes or with trials of 100% organic cotton items.

cotton items, is improving. Blending actually seems to be losing importance as a strategy. Many textile mills now consider it to be more interesting, technically and financially, to produce higher-priced 100% organic cotton items rather than blended 3%–5% organic cotton items for which no higher price is being paid by the buyer.

There are many spinning mills and integrated textile mills involved in the production of organic cotton items today.³¹ Most organic cotton spinning takes place in Turkey and in India, but there is also spinning in China, Indonesia, Mexico, Pakistan, Peru, Portugal, the Republic of Korea, Switzerland, Thailand and the United States. The largest organic cotton spinner in the world today is Sanko Textile in Turkey, which reportedly spins all estimated 8,000 tons of fibre from the Mavideniz project in Turkey. The second-largest spinner of organic cotton worldwide probably is Indorama, in Indonesia, which claimed to be using around 2,500 tons of fibre in 2006, or 10% of the global market. Speciality spinners are also involved in organic cotton spinning, as is for example the case of Hermann Bühler Yarns (Switzerland), which specializes in very fine yarn counts, and Güçbirliđi Tekstil (Turkey), spinning yarn from naturally coloured cottons.

In the other stages of the textile chain (e.g. knitting/weaving, dyeing, mercerizing and confection) the infrastructure for separate processing and handling of organic cotton products is also expanding. Most companies entering into organic cotton usage started (and still start today) selling knitted shirts, dyed and/or printed, the production of which does not require high minimum volumes. Woven organic cotton items are not yet very common in the marketplace. Minimum quantities in weaving are much higher than for knitting, thus increasing financial risk.

Up until 2005 it was very difficult for consumers to find products such as jeans made of organic denim. Denim mills require huge minimum volumes to run. Today, however, there are a growing number of suppliers of organic cotton denim fabrics for jeans, including Cone Denim (United States), Hellenic Fabrics (Greece), Ital Denim (Italy), Isko (Turkey), Orta Anadolu (Turkey) and Tavex (Spain). The infrastructure of the organic cotton market is strengthening and expanding, and as a result a wider range of fashionable products is becoming available to end-consumers.

Retail of organic cotton items

The retail of organic cotton textiles and clothing is increasingly conforming to regular textile and clothing sales. Thanks to the involvement of the large brands and retailers, the number of points of sale is expanding rapidly, thus literally bringing organic cotton items to consumers. Consumers no longer have to go to unique specialized stores and boutiques, changing their purchasing habits in order to access the items.

Organic cotton items can now be found for sale in top locations such as high-street fashion shops as well as in supermarkets, for example:

- The Celio, Levi's and Quiksilver stores in Forum les Halles in Paris (France);
- The Sportarena department store in downtown Frankfurt (Germany);
- The Bijenkorf department store on Dam Square in Amsterdam (Netherlands);

³¹ For a listing of actors involved in the production, processing and trade of organic cotton, see the Organic Cotton Sourcing Directory 2006 at www.organicexchange.org and PAN's International Organic Cotton Directory at www.organiccottondirectory.net.

- ❑ The Topshop department store in Oxford Street in London (United Kingdom);
- ❑ Nordstrom's department store in the Fashion Show Mall in Las Vegas (United States);
- ❑ Timberland's Outlet Store in Potomac Mills in Washington DC (United States);
- ❑ Supermarkets including Coop (Italy), Coop (Switzerland), Migros (Switzerland), Monoprix (France) and Wal-Mart (United States);
- ❑ Natural and health food supermarkets including AlNatura Biomarkt (Germany), Biocoop (France), Natuurwinkel (Netherlands) and Whole Foods Market (United States).

Organic cotton items are also for sale today in stores outside Europe and the United States, for example in Australia, Brazil, Egypt, Japan, Mexico, the Republic of Korea and South Africa. Points of sale in organic cotton producing countries are still few, except for the United States.

Choice in organic cotton items is still fairly limited. Most retailers offer only a few labels and a few products, in very few styles, colours and fits. In fact, there is tremendous room for growth if current sales of organic cotton items are found to be economically attractive by brands and retailers. The infrastructure is there at retail level to rapidly expand the sale of organic cotton items.

Mail order remains an important sale channel for organic cotton textiles and clothing, as geographically dispersed consumers can be reached at low cost, and can be informed about the backgrounds of organic cotton production and processing. The importance of mail order sales in overall sales may have gone down relatively over recent years. In Germany, there has been a reduction in usage by the organic cotton market leader OTTO, which is also the leading European mail order company in textiles and clothing. Number two Hess Natur, however, has recovered from its 2000 sales crisis, and Greenpeace-Germany, which then quit, is now back in the market. In France, mail order has gained importance through companies such as Somewhere/La Redoute, Vertbaudet, Le Camif and Fibris. In the United Kingdom and the United States mail order is also of importance, with suppliers such as Gaiam (United States), Greenfibres (United Kingdom) and many smaller ones.

Pricing and positioning

Economies of scale, increased efficiency in the organic cotton textile chain, and the pricing policies of individual companies, have made 100% organic cotton items much more accessible to consumers than before, when they were often sold as high-priced, exclusive items. Organic cotton items are now also available in medium and lower price segments of the market, making them more accessible to the average consumer. Overall, organic cotton items have become less expensive, even if the price often still is significantly higher than for comparable conventional items.

The pricing and positioning of organic (and conventional) clothing items depends, among other things, on a company's sale strategies. Companies have different options available. They may, for example, decide to position organic cotton as a luxury item, targeting fashion-oriented consumers who are looking for exclusivity and who are less responsive to price. This was for example the case with EDUN's launch in 2005 of the sale of exceptionally high-priced organic cotton trousers (up to \$250 per piece) and printed shirts (up to \$100 per piece). Pricing of organic cotton items may also be deliberately higher in order to obtain a higher profit margin on this new and exclusive product.

However, companies may equally well decide to temporarily support the sale of organic items, for example offering them at conventional prices (i.e. at a lower profit margin), in order to gain market share or to create a market where none exists. Coop Switzerland, for example, deliberately subsidized its organic cotton sales for many years in order to create a market. Another option is of course for companies to price organic items realistically, incorporating in the price of the organic items only the actual additional costs of organic cotton fibre compared to conventional cotton.

Consumers now also find items in the market that contain only some percentage of organic cotton, as is for example the case in the United States of Nordstrom's 5% organic/95% conventional cotton shirts for men. Blended items tend to be sold at conventional prices. No publicity is made to consumers about the blending unless on the product label inside the item or on a hang-tag.

'Fair' pricing

Organic cotton fibre itself is more expensive than conventional cotton fibre, because of higher production costs and often also lower yields.³² However, this does not necessarily have to translate into a much higher price of the end-product as long as the percentage of fibre price in the total product value is limited.

Overall, it is estimated that the value of a clothing item is about 25–30 times the value of the fibre that is contained in it. A mark-up of around 30%–50% on the price of organic cotton fibre (i.e. on 3%–4% of total value) would then translate in a 1%–2% mark-up on the final clothing product, or EUR 0.25–0.60 on a standard-priced shirt of EUR 25–30. If the product is sufficiently fashionable, having an attractive design, colour and fit, end-consumers will normally not care about such a price difference.

However, in practice we see that the mark-up on prices of organic cotton items is much higher. Depending on the item, retailer, sales channel and so on, retail mark-ups are generally about 20%–40%, but occasionally 100% or more. The higher sales price is usually explained by the additional costs relating to smaller scale, separate handling and additional labelling, and by overhead costs.

Geographical markets and large brands

The United States is the biggest market for organic cotton and eco-textiles. Current organic cotton consumption in the form of apparel end-products in the United States is roughly estimated at 9,500 tons (41% of the world total) against 7,000 tons in Europe (30% of total).³³ Japan is estimated to consume the equivalent of about 350 tons of organic cotton per year. Other markets exist in the rest of Asia, in Australia, in Canada, in Egypt and Israel, and in South Africa.

In Europe, organic cotton usage is highest in Switzerland (about 2,250 tons), followed by Germany (1,500 tons), the United Kingdom (about 750 tons), France (600 tons), Sweden (350 tons), Italy (250 tons) and the Netherlands (100 tons). Smaller markets exist in other European countries including Austria, Belgium, Denmark, Greece, Finland, Ireland, Latvia, Norway, Portugal and Spain.

³² Scarcity is sometimes cited as an additional feature.

³³ These figures take into account the fact that many United States-based textile and clothing companies involved, including Levi's, Nike and Timberland, sell a significant part of their production internationally.

The importance of large brands and retailers in the use of organic cotton fibre is increasing steadily. An estimated 58% of organic cotton fibre worldwide is taken up by just 25 brands and companies. Some of these brands sell their organic cotton items throughout the world.³⁴

The biggest user of organic cotton fibre until now, United States-based Nike, is one of the brands selling internationally. The focus of Nike's original blending and conversion programmes was first on the United States. Today, the organic cotton programme relies more on the company's Europe, Middle East and Africa division, based in the Netherlands.

Nike's own estimates for 2007 are that Europe, the Middle East and Africa will sell 84% of all Nike's 100% organic cotton items, and the United States just 3% of the total. For the organic cotton blending programme (blends of 5% or more organic cotton), the United States accounts for 37% of units sold, against 44% for Europe, the Middle East and Africa. This difference in orientation of organic cotton use across geographical markets is likely to be related to the availability and price of organic cotton fibre, yarn and fabrics in the United States and the Europe, Middle East and Africa region.

Outdoor wear company Patagonia is now the fourth-largest user of organic cotton fibre worldwide, with an annual consumption of about 650 tons. Patagonia sells its products in the United States, in Europe and in Asia. The organic cotton it uses comes primarily from the United States and from Turkey.

United States of America

The consumption of organic products in the United States has been increasing for many years, and was strengthened by the introduction in 2002 of the National Organic Programme (NOP) administered by the United States Department of Agriculture (USDA). The growth rate of the organic food sector was 18% per year on average since 1997, while the conventional market grew by only 3%. The organic market share thus tripled to 2.5% of total in 2005 (OTA, 2006).

In 2005, organic turnover amounted to \$14.6 billion (EUR 12.2 billion). Sales of organic food products grew by 17%. Turnover of non-food products including textiles and clothing, cosmetics, flowers and animal feed, increased by 33% to \$774 million (OTA, 2006). Consumption of organic products is largest in the north-east around New York and Washington, and on the West Coast in California. However, sales are increasing throughout the United States now that organic products are being included in the regular offer of shops and supermarkets.

Total United States organic cotton consumption is approximately 9,500 tons of fibre, or 40% of global production and trade. Wal-Mart is the leader in organic cotton usage in the United States and in the world today. In 2006, it bought an unprecedented 10,000 pounds of cotton fibre (4,500 tons) at once. A wide range of organic cotton items is currently being manufactured, and will be available for sale in 2007. Wal-Mart started sales of organic cotton items in 2005 through its subsidiary Sam's Club (yogawear). In 2006 it launched sales in Wal-Mart supermarkets of babywear under the label 'George Baby Organic'.

Up until 2003, sale of organic cotton items in the United States relied predominantly on electronic commerce, mail order catalogues, natural and health food stores, and small specialized eco-textile shops or boutiques. Today, however, regular shops and supermarkets also have organic cotton items for

³⁴ Wal-Mart is the largest organic cotton fibre user in the world today. Its organic cotton items are so far only for sale in the United States. Expansion to other countries and regions may occur if United States sales are successful.

sale, including the department stores of Nordstrom, the brand stores of American Apparel, Levi's, Nike and Timberland, Wal-Mart supermarkets, and the natural food giant Whole Foods. Electronic commerce and mail order purchases remain important though. They are also more common for United States consumers than for Europeans.

In the early stages of the United States eco-textile market, organic cotton items tended to be made primarily with United States-grown cottons. However, strategies for cost reduction and increased economic efficiency now lead United States companies to increasingly source their organic cotton elsewhere – mostly in Turkey, but also in China, India and Pakistan. United States cotton is relatively expensive, as is local textile processing, which has experienced a significant decrease since 2000. The larger companies are accustomed to sourcing their cotton, yarns, fabrics and garments in lower-wage countries. Many also work with decentralized purchasing and sales, which favours sourcing organic cotton outside the United States.

An exception to the trend of textile industry relocation is the brand American Apparel, which uses United States cottons to process 'sweatshop-free' 100% United States-made T-shirts in downtown Los Angeles. The company's turnover has increased 50% per year since 2002, to \$210 million in 2005. American Apparel has used organic cotton fibre for the unbleached and undyed Sustainable Edition collection since 2003, but usage is still small. American Apparel sells its products through department stores and regular shops, and runs own-brand stores. Recently, sales were expanded to Europe with the opening of shops in Amsterdam, London and Frankfurt, among others.

Switzerland

In Europe, Germany has long been considered to be the largest market for organic cotton textiles. Today, however, Switzerland is the largest European user of organic cotton fibre, thanks to the involvement of the two main supermarket chains Coop and Migros, which offer 100% organic cotton items for sale. T-shirt producer Switcher is the third-largest retailer involved in the Swiss organic cotton market, selling items through its own stores as well as through supermarkets and department stores.

Total organic cotton usage in Switzerland is estimated at 2,250 tons of fibre, of which Coop carries 1,428 tons (63%), Migros about 500 tons (22%) and Switcher 150 tons (7%). According to the NGO Helvetas, which actively promotes organic cotton, the Swiss Government has agreed to aim for 5% of Swiss cotton fibre use to be organic in 2007; the equivalent of about 2,700 tons of fibre. One way to reach this goal is through 'green public' purchasing. The police of Zürich, for example, recently committed to purchasing uniforms made of organic cotton.

Switzerland is the second largest market for fair trade products in Europe after the United Kingdom (Krier, 2006). Max Havelaar food products are carried by Migros and Coop under special labels. Max Havelaar Switzerland has been a pioneer in the launch of fair trade cotton, next to Max Havelaar France (see below). Fair trade cotton textiles and clothing currently for sale include T-shirts, babywear, towels, bathrobes and cotton wool products. These are available at Migros supermarkets, Manor department stores, the Switcher points of sale, the mail order companies La Redoute and Lehner Versand, and at retailers of home textiles.

Germany

Germany is the largest market for organic products in Europe, and also has the highest population in Europe (82 million). Environmental awareness is high in many layers of society.

German companies have been at the forefront of the development of the market for ecological textiles. Demand for *Naturtextilien* (natural textiles) was fuelled in the early 1990s by concerns about skin allergies caused by textile dyes and clothing accessories, and by a strong movement of ‘green’ consumers. Also, the major German textile and clothing industries were interested in converting their production to higher-value items, such as organic items, in order to cope with the competition from low-wage countries in the production of textiles and clothing.

Consumption of organic cotton in Germany was estimated to be the equivalent of about 1,500 tons of fibre in 2006. Eco-textile sales in Germany have always been dominated by mail order companies. Specialist Hess Natur was the largest eco-textile selling mail order company up to 2000 when the much larger OTTO took over. Other mail order companies selling organic cotton textiles and clothing in the German market include Greenpeace-Germany, Hans Natur, Maas Natur and Waschbär. The large German mail order company Neckermann, which has owned Hess Natur since 2001, recently launched its first sales of organic cotton textiles (bioRe 96% organic cotton bed linen). Neckermann is part of the Karstadt/Quelle group.

Organic cotton items are also for sale in Germany in specialized natural and health food stores, including the large AlNatura Super Natur markets. These sell a wide collection of 100% organic cotton Cotton People Organic babywear which is produced in Egypt, and some hygienic products for daily use (Bo Weevil 100% organic cotton wool, Natracare 100% organic cotton tampons).

The sale of organic cotton items by high-street retailers is increasing rapidly in Germany. In August 2006, for example, the author encountered organic cotton items for sale in downtown Frankfurt in the department store Sportarena (Nike’s 100% organic cotton shirts), the Timberland brand store (15%, 6% and 5% blended items), the Grüne Erde natural store (100% organic cotton home textiles and bed wear, including brown and green naturally coloured cottons), and the new American Apparel store (100% organic cotton T-shirts). The Dutch company C&A, which is an important actor in the German market, plans to follow this organic trend by blending 1% organic cotton into its cotton products by 2008.

Germany has a significant number of small and medium-sized eco-textile processing companies, many of which gather twice a year at InNaTex, the international trade fair for ecological textiles. About 200–250 companies exhibit at InNaTex, most of them German. They sell organic cotton items, but also many other products made out of silk, wool, linen and bamboo. Most visitors are representatives of small and medium-sized natural textile shops.

United Kingdom

The United Kingdom is one of the fastest-growing markets for organic food. In 2005, the organic market increased by 30%, three times the rise of the previous year. More and more United Kingdom consumers look to organics as a way to reduce their environmental impact and enjoy eco-friendly products. Organic cotton usage in the United Kingdom is estimated to be the equivalent of 750 tons of fibre.

Popular high-street retailers such as Topshop, Marks & Spencer (M&S), Next, and Oasis, and supermarkets such as Asda already sell organic cotton items or are preparing to do so in 2007. Tesco will launch a 100% organic cotton collection by top designer Katharine Hamnett. Successful United Kingdom brands selling organic cotton textiles and clothing include People Tree, Hug, Gossypium, Seasalt and Ciel, and mail order companies such as Greenfibres and Howies (Soil Association, 2006).

A big push forward for the organic cotton market in the United Kingdom was expected from M&S, which announced in 2003 that it would convert an increasing percentage of its cotton use to organic. This has not yet materialized however. Today, M&S's focus is on fair trade cotton items, for which it is now establishing itself as the leading retailer worldwide.

One of the new United Kingdom brands in organic cotton is Next which sells clothing and home furnishings. Next has close to 400 stores in the United Kingdom, and some in Ireland and Denmark. It is also represented through 80 franchise stores in 14 other countries in Europe and in the Middle and Far East. In addition, Next sells by mail order and through electronic commerce, and had about 2 million active customers in 2005. Turnover of the Next Group was EUR 4.3 billion (GBP 2.9 billion) in 2005.

In 2006, Next investigated opportunities to develop specific ranges in 100% organic cotton across its business. A trial range of four women's jersey long- and short-sleeved tops and ecru jeans went into store in September 2006. A range of organic babywear is also on sale (three-packs of bodysuits and sleepsuits for newborn boys and girls). 'For 2007, the number of organic cotton products will be expanded to include women's, men's and childrenswear. Next is also exploring the opportunities for fair trade cotton, and hopes to have a small range of products on sale in 2007', writes Next's Philippa Dalton (20 October 2006).

The United Kingdom certification body Soil Association reports high interest from fashion brands for organic textile certification. In 2007 the Soil Association will adopt the new Global Organic Textile Standards (GOTS), together with other international organic textile certifiers.

France

France is another booming market for socially and environmentally responsible cotton products. France has been a pioneer in the development of fair trade cotton, and the fair trade movement is supported financially by the French Government. Organic cotton consumption is also increasing. Organic cotton textiles and clothing can be encountered with surprising ease in the French capital Paris today. Consumption in 2006 is estimated at 600 tons of fibre.

Supermarket chain Monoprix is the main French retailer of organic cotton products, with a consumption of 163 tons of bioRe cotton in 2005. Monoprix sells 100% organic cotton clothing products under different labels for babies (Bout'Chou, whole range), children (C.F.K. sweaters and underwear, WWF shirts), men (Derby underwear, Autre Ton printed shirts) and women (Miss Helen underwear and nightwear). Monoprix's household textiles and bed linen do not yet include organic cotton products, nor do the hygienic cotton products. Many textile and clothing products at Monoprix carry the skin-friendly Oeko-Tex label, including some of the 100% organic cotton items.

Another major French retailer is the textile and clothing company Celio, which has a total of 370 shops, of which 220 are in France and the others elsewhere in Europe, the Middle East and the Maghreb. Celio is the leader in the French market for menswear, before Gap, H&M, Zara and others (Collomp, 2006). Celio now carries a range of printed T-shirts made of 100% organic cotton. Celio is also involved in the sale of Max Havelaar-labelled fair trade socks.

French mail order companies carrying organic cotton items include Somewhere/La Redoute, Vertbaudet, La Camif and Fibris.

The French market for fair trade products is growing rapidly. Max Havelaar France pioneered the production and trade of fair trade cotton in 2004, with first sales starting in spring 2005. Fair trade cotton was launched with a range of textile and clothing products. Sales in Belgium, Switzerland and the United Kingdom followed soon after.

In 2006, there were 27 companies registered by Max Havelaar France for the production and sale of fair trade cotton items in France. The fair trade cotton items are for sale in main supermarkets and department stores (Auchan, Carrefour, Casino, Cora, Intermarché and E. Leclerc), through mail order and over the Internet (La Redoute, La Camif), as well as through specialized stores and brand stores.

Other markets

Further markets for organic cotton textiles and clothing products can be found in the other European countries (including Eastern Europe), in Japan and the Far East (China, Malaysia, Singapore, the Republic of Korea, Thailand), in Canada, in Australia, in the Middle East (including Israel, Egypt and Turkey), as well as in countries of low average income but with significant segments of society enjoying a medium to high income (such as Brazil and South Africa).

Future development of the organic cotton market

In order to develop a better idea of the future prospects of the international market for cotton products, a holistic view of the entire fibre-to-clothing value chain is needed. This chapter examines the arguments for and against expanding production of organic cotton, at each stage in the chain, as well as the strengths, weaknesses, opportunities and threats of the industry.

Arguments in favour of expanding organic cotton

Production

- ❑ Organic cotton is in demand. Production and trade increased 70% per year on average between 2001 and 2006, and have more than doubled annually since 2004.
- ❑ Cotton is an important rotational crop for many organic farmers in the world. Its cultivation will increase with growth of the market for organic produce.
- ❑ The additional production costs of organic cotton may be limited in systems with multiple organic crops, while overhead costs can be shared between various crops.
- ❑ Organic cotton production also has potential in production systems where cotton is the main cash crop or the sole cash crop. Here, market prices, access to information and production efficiency are important parameters in farmers' decision-making about whether to convert to organic production.
- ❑ The infrastructure for organic cotton training and extension is expanding. Much can be learned from training and extension approaches for integrated pest management (IPM) and integrated crop management (ICM).
- ❑ Improved access to information technology is facilitating the exchange of experiences, expertise and ideas for organic cultivation methods, as it is for marketing of the organic produce.

Processing

- ❑ Many spinning and textile mills around the world are involved in organic cotton processing. This favours economies of scale in processing.
- ❑ Blending organic cotton at some minor percentage at the level of spinning is an effective way to increase fibre demand at low cost.
- ❑ Infrastructure for the knitting of organic cotton is well established, more so than for weaving, because of the lower minimum quantities required per production run. Brands and retailers generally start with the production and sale of knitted items when first engaging in organic cotton usage.

Retail

- ❑ The concept of ‘organic cotton’ is successfully being marketed to brands and retailers in the fashion industry as being part of their policies for CSR.
- ❑ The new involvement of large brands and retailers increases the number of points of sale exponentially, making organic cotton items available to consumers in the usual points of purchase for textiles and clothing. Organic cotton items are increasingly found in regular sale channels such as high-street fashion shops, department stores, and supermarkets.
- ❑ The involvement of large fashion brands and retailers in organic cotton use generates much attention from other parts of the textile industry, from designers and from the media. This further strengthens consumers’ interest in organic cotton textiles and clothing, and their willingness to purchase.

Infrastructure

- ❑ Demand for organic products has become significant in the main consumer markets (United States, EU, Japan), even when market share is still small.
- ❑ Textile and clothing brands and retailers are increasingly aware of, and responding to, the need for comprehensive CSR policies.
- ❑ The organic cotton sector consists in a network of brands and retailers and international NGOs on environment and development, the latter often with financial support from public funds.
- ❑ Organic Exchange provides an active and productive platform for exchange between businesses involved in organic cotton.
- ❑ Communication to consumers of the involvement of brands and retailers in organic cotton use is organized by the brands and retailer themselves.
- ❑ Fair trade cotton creates a unique opportunity for smallholder farmers, including organic cotton producers, to increase their visibility, their income and their development.

Arguments against expanding organic cotton

Production

- ❑ The demand for organic cotton fibre currently outstrips supply. Supply growth is lower than demand growth.
- ❑ About half of global organic cotton is produced by two single projects – one in Turkey and one in India. This points to a fragile market.
- ❑ Easy options for production expansion were available a few years ago, when the market for organic cotton was much smaller than the market for other crops in the organic production system. Cotton could then relatively easily be added as a rotational crop. This is less the case today.
- ❑ Organic agriculture provides technical challenges to ensure appropriate yields and income. Conversion to organic takes time, knowledge and expertise.
- ❑ During the conversion to organic agriculture farmers are usually not rewarded with a price premium for their in-conversion produce. Organic farmers face significant financial risks in conversion.
- ❑ Conversion to organic will be easier in some production areas than in others – technically, organizationally and socio-economically. Decision-making about the promotion and development of global organic cotton production should take account of this.

- ❑ The conversion to organic farming tends to be more difficult and more expensive in areas where conventional farming relies upon a high use of synthetic inputs, as the yield drop in organic will generally be higher.
- ❑ The growing importance of GM cotton in the world creates direct additional costs for organic cotton production, because of the separation between fields that is required to prevent contamination.
- ❑ Organic crop management techniques are an amalgamation of methods, many of which are little understood by both science and farmers. Research is urgently needed to understand, support and strengthen the organic cotton sector.
- ❑ The premiums paid under fair trade cotton production make it more difficult to motivate conventional farmers to convert to organic. They lean towards the higher fair trade price, as the additional organic premium is comparatively lower.

Processing

- ❑ Organic cotton fibre, yarn, fabrics and garments cannot be distinguished from conventional ones, and generally not even from GM cotton, other than through documentation about production lots and volumes.
- ❑ The additional costs of blending organic cotton at low percentages have thus far not been rewarded by brands and retailers through price premiums. The involvement of spinning mills has been more or less imposed upon them by brands and retailers.
- ❑ Woven organic cotton items are not yet very common in the marketplace. Minimum quantities in weaving are much higher than for knitting, thus increasing financial risk.
- ❑ Spinning is capital-intensive and requires high minimum quantities of fibre. Smallholder producer organizations do usually not have an influence on the processing of their cotton fibre, which is a bottleneck for increasing their influence on, and participation in, the cotton textile chain.
- ❑ Labour issues in processing (spinning, weaving/knitting, dyeing, mercerizing, confection) are not currently considered in the organic rules and regulations.

Retail

- ❑ Organic cotton demand currently outstrips supply.
- ❑ The involvement of large brands and retailers is motivated more by CSR considerations than by expressed consumer demand.
- ❑ Many brands and retailers do not advertise to the general public their involvement in organic cotton, because the organic quality of the product is only an additional feature in consumers' purchasing decisions.
- ❑ Sales agents of brands and retailers involved are often highly uninformed about the very existence of the organic cotton items for sale, and about what organic cotton means and implies. They thus cannot and do not sell it.
- ❑ The positioning of 100% organic cotton items should be at price levels close to conventional cotton, in order to generate volume.

Infrastructure

- ❑ The cotton crop is not adequately covered by public organic regulations in the main consumer markets (Europe, United States, Japan).

- ❑ There are no regulations in place to ensure that organic cotton items sold to consumers actually carry organic cotton fibre, other than several private schemes which have not yet found large recognition in the marketplace.
- ❑ The organic cotton sector is not yet well recognized by the international cotton community despite the increasing involvement of large brands and retailers.
- ❑ With organic cotton demand outstripping supply, prices are likely to go up. This increased price differential between organic and conventional cotton enhances the opportunity for profit-making and consequently the risk of cheating.
- ❑ The second-largest actor in the marketplace (Nike) claims to be committed to third-party certification, however only part of the supply chains is covered (up to the spinning mill). There is no third-party certification for other processing stages.
- ❑ There are no comprehensive mechanisms in place that back up the claims made by brands and retailers about the amount of organic cotton fibre they use.
- ❑ The Organic Exchange Blended Standards and related certification act as a track and trace system that is internal to companies that sign up. No actor can establish whether the data provided are in accordance with reality.
- ❑ The concept of ‘organic cotton’ as understood by the general public is to a large extent built upon information about cotton production systems (health, environment, socio-economics) that form only a minor part of organic cotton production. Africa’s situation is often over-publicized in the media.
- ❑ Organic cotton production as such has not yet proven to be an economically attractive alternative for conventional farmers in many areas in the world.
- ❑ Public support for organic cotton market development is usually justified by concerns about smallholder farming in poor countries (for example in Africa). However, this support may well lead to the promotion of production by middle income countries (such as Turkey) or large-scale producers (Australia, United States).

Opportunities

Production

- ❑ Organic cotton production has potential in areas where cotton is the main cash crop or the sole cash crop, as long as market prices, access to information and production efficiency are ensured.
- ❑ Organic cotton projects in countries in the South may aim for participation in fair trade to receive a higher price for most or part of their produce.
- ❑ Fair trade cotton growers have a higher probability of becoming organic fair trade producers than conventional producers, because of their more frequent linkage with consumer markets. Fair trade cotton eliminates the use of the most toxic and dangerous cotton chemicals in production.
- ❑ Farmers produce seed cotton not cotton fibre. With demand outstripping supply in the next few years, organic cotton fibre prices may increase. This would create opportunities for producers and their organizations to claim higher producer prices for seed cotton.

- ❑ Brands and retailers continuously develop and refine their CSR policies. The probability is increasing that they will in future go beyond issues such as energy, environmental performance and labour conditions, to also include specific attention to the fate of producers in resource-poor Africa.

Processing

- ❑ Organic cotton demand will continue to grow in the future, thus increasing the number of spinning and textile mills involved, and enlarging the range of intermediate and end-products available to the industry and to consumers.
- ❑ With demand outstripping supply, organic cotton prices are likely to increase. This creates opportunities for processors to increase the price of organic cotton yarn, fabrics and garments beyond the additional production costs of organic cotton.
- ❑ Brands and retailers using organic cotton are likely to be among the first to welcome and implement globally agreed standards for organic textile processing.³⁵ Organic textile processing is a logical next step adding value to organic fibre use.

Retail

- ❑ The importance end-consumers attach to health and 'wellness' is likely to increase in time, to the benefit of organic agriculture and trade.
- ❑ Price differences between organic cotton items and conventional items may decrease, because of more efficiency in processing (higher-volume production runs, etc.), and following increased product availability. Organic cotton items may evolve in the marketplace from being a speciality item towards becoming commonly available goods.
- ❑ Consumer information about the organic nature of organic cotton items (for example through labels inside, hang-tags, consumer brochures or advertisements) is still in its infancy. New strategies and tools may be developed by brands and retailers to cash in on their involvement in organic cotton, improving their image and profile among consumers.
- ❑ The growing interest in CSR issues throughout the cotton textile production chain may eventually lead to the development of a global system of textile labelling inside clothing that incorporates the production history of the item.
- ❑ The value of the cotton fibre contained in textile and clothing items makes up only a small part of their retail value. As such, the textile and clothing industry has room for manoeuvre to incorporate a higher producer price for fibre input.

Infrastructure

- ❑ High-profile brands and retailers are not likely to take the risk of making unsubstantiated claims about organic cotton usage without adequate documentation, control and certification.
- ❑ High-profile brands and retailers will increasingly require information from their suppliers about the production and processing conditions in the cotton textile production chain.

³⁵ The Global Organic Textile Standards (GOTS) seem to provide a good vehicle for this. However, the GOTS have been criticized by some large players such as M&S for being insufficiently adapted to their consumer demand, scale and practices.

- ❑ Documentation of the social and environmental aspects of cotton production and processing may eventually become the norm in the cotton and textile production chain.
- ❑ With demand outstripping supply, brands and retailers may increasingly become involved in the development of organic cotton conversion programmes in producing countries, in order to ensure their access to organic cotton supply.

Threats

Production

- ❑ Demand for organic cotton fibre depends on the reliability of the claims made about its 'organic' origin and production. Transparency of the chain is thus far often limited to qualitative information (who works with whom).
- ❑ The organic cotton sector does not seem to be able, now or in the near future, to meet the current explosion of interest in purchasing organic cotton fibre, yarn and fabrics. If demand cannot be met, the image of the organic cotton sector will be affected and many newcomers may lose interest, and prefer to focus on the use of other sustainable cottons.
- ❑ Organic cotton will not be accepted by many brands and retailers as the only way to move towards better CSR policies. Interest in other, additional approaches such as 'Better Cotton', 'cotton from origin' (whether United States, Peru, Africa, or similar), IPM or ICM cotton is expected to grow over the next few years.

Processing

- ❑ There are no clear mechanisms to bind spinning and textile mills to voluntary networks such as Organic Exchange, or to third-party certifiers, and to thus have some sort of internal control over usage claims and their substance.
- ❑ Once organic cotton has become a common good and is taken up also by medium- and low-profile brands and retailers, the opportunity for cheating by spinners and textile mills may increase. Medium- and low-profile brands and retailers run a higher risk of fraud by suppliers.

Retail

- ❑ Selling organic cotton items may remain a one- or two-year fashion trend for some brands that are in the marketplace today.
- ❑ It remains to be seen whether brands and retailers that explicitly promote 100% organic cotton items as 'organic' will be able to sustain sales and involvement after one or two years. Fashion is ephemeral in its tastes. Organic, however, is a feature that is not.
- ❑ Blending is an approach that provides new brands and retailers with an easy entry to the organic cotton sector. It is relatively easy to accomplish without too much cost. Blending contributes to achieving NGO approval for CSR policies, and it may also provide free publicity. From the perspective of the organic cotton sector, there is a risk that blending only a small percentage of organic cotton would be a substitute for a more profound involvement in organic cotton use by brands and retailers.

Infrastructure

- ❑ Brands and retailers develop CSR policies out of longer-term concerns. Organic cotton use can be part of that, but does not have to be. Brands and retailers may well opt for other cotton purchasing policies.

- ❑ Organic cotton usage creates a lot of free publicity for involved brands and retailers and NGOs. Longer term issues such as building a strong market and supporting the very farmers that grow organically may be disregarded at times by the symbiotic bond of businesses and environment and development NGOs.
- ❑ Publicity for the involvement of larger brands and retailers in organic cotton is often premature, happening at the announcement of involvement rather than on sale of the items.
- ❑ Until recently, brands and retailers were not used to dealing with actors in the cotton textile chain other than the garment manufacturers. Many of them are now starting to be interested also in the origins of the goods they buy. It is not likely, however, that many will go as far as committing in the short-to-medium-term to supporting specific organic cotton production projects.
- ❑ With demand for organic cotton fibre increasing, cotton traders and ginneries will express a growing interest in setting up their own internal infrastructure for organic cotton production and trade.
- ❑ Organic agriculture will increasingly be confronted with the risk of contamination by GM organisms, as GM crops are progressing today even in reluctant consumer markets (such as Europe) and producer countries (such as West Africa).

Conclusions

Corporate social responsibility (CSR) is increasingly shaping the policies of brands and retailers in the textile and clothing industry. As companies become aware of the impacts conventional cotton production has on farmers and farming communities, they consider alternative cottons, to serve consumers and to improve their public image.

One of the alternatives to conventional cotton fibre production is organic cotton production in which hazardous chemicals are no longer employed – this to the benefit of farmers, workers, domesticated animals and the environment. The first certified organic cotton was produced in Turkey and the United States in the early 1990s. In 2006, organic cotton was produced in 22 countries worldwide.

Organic cotton production

Global production and trade in organic cotton was estimated at about 23,000 tons of fibre in 2006, against 6,000–6,500 in 2001, and 10,000 tons in 2004. Production growth thus was an annual 70% over the period 2001–2006, reaching 120% per year since 2004. Despite this impressive growth, traded organic cotton fibre still represents only 0.09% of the 24.8 million tons of cotton fibre traded worldwide.

Organic cotton production is concentrated in Turkey (10,000 tons of fibre, 43% of the world total) and India (6,500 tons, 28%), where growth has recently also been most spectacular. Together they produced more than 70% of the world organic cotton supply in 2006. Other relevant producers in terms of volume are China (1,750 tons, 8%), the United States (1,500 tons, 7%), African countries (1,800 tons, 8%) and Peru (750 tons, 3%). Countries that have started or restarted organic cotton production include Australia, Burkina Faso, Kenya, Kyrgyzstan, Nicaragua, Pakistan, South Africa and Zambia.

More than half of the global production of organic cotton fibre is in the hands of just two companies: Mavideniz in Turkey, with about 8,000 tons of fibre in 2006 (35% of the world total) and Eco-Farms in India, with 4,000 tons of cotton fibre in 2006 and an estimated 6,000–7,000 tons of fibre in 2007. This high concentration of production in two single projects points to a fragile

market, and to a vulnerability of supply. The performance of these two projects in terms of quality, price, reliability of supply, control and certification, and transparency, may determine the future of the global organic cotton market in the short and medium term.

Expansion of organic cotton production is required in order to meet the demands raised with brands and retailers in the textile and clothing industry. Easy options for production expansion were available a few years ago, when the market for organic cotton was lagging far behind the market for other crops in the organic production system. Cotton could thus relatively easily be added as a rotational crop.

In the near future, cotton may eventually become the motor for agricultural change, inciting farmers to convert their land to organic agriculture because of a relevant market for organic cotton. Demand growth will need to be sustained for that to occur.

Organic cotton production in Turkey is expected to increase further, also thanks to the introduction of national subsidies for organic agriculture. Production in India is expected to increase rapidly over the next years, particularly when and where produce can be sold as organic fair trade. Production can also be increased in Africa, but infrastructure for large-scale projects is yet to be build. Information about the production potential in China is difficult to obtain, but growth is expected. United States production will likely continue to lag far behind United States demand.

Conversion to organic agriculture is not easy. It takes knowledge, time, investment, and a lot of motivation and organization. Markets can incite conversion only in part through demand growth. Farmers and their organizations need support to build capacity to convert to organic agriculture, in particular in order to bridge the conversion period and related risks of production.

Organic cotton processing

The infrastructure for processing organic cotton fibre has improved tremendously over recent years, thanks in part to the awareness-raising of spinning and textile mills that was induced by the blending programmes of large brands and retailers. Today, virtually any quality of yarns and fabrics can be produced from organic cotton.

The processing of blended yarns (about 5% organic) has been little rewarded thus far by brands and retailers, and therefore is less interesting to spinning and textile mills than producing 100% organic cotton items. However, blending helps mills to learn about organic cotton and to obtain access to sources of organic cotton fibre.

Demand for organic cotton fibre is outstripping supply today and will continue to in the near future. This creates opportunities for the processing industry to increase the price level of yarns, fabrics and garments, and to augment profit margins on organic items.

Consumer demand for organic cotton textiles and clothing will increase now that items are for sale through regular sale channels and in regular qualities and designs. The industry will progressively include the environmental and health aspects of textile processing in their CSR policies.

Retail of organic cotton items

Demand for organic cotton fibre is outstripping supply today, and is likely to continue to do so in the near future. The marketing of 'organic cotton' as a concept has been so successful over the last years that new entrants risk becoming rapidly disappointed by lack of product availability. This might

generate a loss of interest in organic cotton among some of these new brands and retailers. The shortage of supply could also result in organic cotton items being positioned in higher-priced market segments.

Around 50%–60% of the global organic cotton fibre is taken up by some 25 large brands and retailers, with the rest feeding into the sales of medium and small-scale specialized retailers of organic cotton textiles and clothing.

Current demand for organic cotton fibre is particularly induced by CSR considerations. Many brands and retailers engage in organic cotton fibre use in order to seek approval and publicity from environment and development NGOs, investors, governments and consumers. Companies' communication to end-consumers about their organic cotton involvement is often still limited. Some brands and retailers do not want their products to be associated with organics, while their textile and clothing items are sold on other features: image, design, colour, fit, price, etc.

In any case, the CSR-induced demand is an important stepping stone towards consumer-led demand for organic cotton textiles and clothing, while increasing general awareness and product availability. Consumer-led demand will have to be the basis in future for the development of global organic cotton production and trade.

The promotion of organic cotton fibre as a product originating from organic farming systems relates to agricultural change. The aim of actors in the organic cotton sector should be to increase the benefits of organic farming to producers, and to smallholders in particular. Organic cotton can be a tool for rural development.

Infrastructure of the organic cotton market

Today's market for organic cotton has been shaped by a coalition of large brands and retailers, organic cotton producers, and supporting environment and development NGOs. There are powerful trade-offs between these three parties.

The brands and retailers express demand, and they motivate and push the processing industry into organic cotton use. The organic cotton producers generate produce in spite of the complexities of organic farming and of a sometimes hostile social environment. Environment and development NGOs, in turn, provide brands and retailers with very valuable third-party endorsement of their CSR policies. They generate free publicity, and they also often finance operations and costs at the producer level, which are thus not integrated in the cost price of the organic cotton fibre.

Consumers are attracted by organic cotton items thanks to the existing rules and regulations about organic agriculture, which take away mistrust and actually give them confidence in the 'organic' claims being made.

Producers and their organizations have participated in the organic cotton business network Organic Exchange since 2005 through separate farmers' meetings, where they are often represented by third parties such as buyers, consultants, NGOs or donors.

Opportunities for cotton ginnery and exporters

The demand for organic cotton fibre is increasing. New opportunities are emerging for cotton exporters, many of which are large companies that have so far considered organic cotton to be too small in scale to be attractive.

Regular cotton research has thus far not been engaged in organic cotton research. This situation may change with growth in demand for organic cotton, and with pressure from the organic cotton industry.

Cotton ginners and exporters are in a crucial position to support the expansion of conversion to organic agriculture while many of them employ their own trainers and extensionists.

Cotton ginners and exporters are the ultimate link in the chain between producers and spinning and textile mills.

Esquel – Case study on responding to market requirements for organic products.

Esquel is a vertically integrated garment manufacturer in China. The company owns facilities from cotton farming to garment manufacturing and therefore has the flexibility to try new things at every step. In line with its corporate culture, which promotes, among other things, environmental protection, Esquel began experimenting with growing organic cotton around 2000. Soon after, it began finding out how its customers reacted to this kind of product.

The reaction was varied. Some customers did not consider organic cotton because they had heard from other sources that the quality was inferior to conventional cotton. On the other extreme, there were customers who wanted the highest quality products, in 100% organic cotton, but were unwilling to pay more for the product.

In each case Esquel found it had to educate the customer, and often its own staff, before it could determine what would work. While the company is continuously developing new product offerings using organic cotton, it has found several general limitations or guidelines:

- ❑ *Organic costs more. In places like China and the United States where cotton is grown on a large scale, high yields can be achieved using conventional chemical farming. Therefore, when switching to organic farming, there is a noticeable drop in yield per acre. This accounts for the higher unit cost of the fibre. Whether the company grows the cotton itself or buys from outside sources, organic cotton adds to the price of the end-product. The challenge for Esquel was to make sure its customer understood the price difference and would pay a premium for this product.*
- ❑ *Fibre strength and other characteristics may suffer. As a natural product, cotton crops will vary from season to season and from location to location. However, in general, organic cotton shows lower strength and other characteristics compared with its conventional counterpart. While the crop quality may have been due to Esquel's inexperience in organic farming, the fact remained that Esquel needed to be aware of those reduced physical characteristics. This affected the kinds of products the company could develop.*
- ❑ *Only short to medium staple is widely available. The vast majority of organic cotton is of the Upland variety. However, Esquel focuses on high yarn count shirts, which require the use of ELS cotton. With a lack of organic ELS in the market, Esquel needed to find new ways of blending organic cotton with conventional cotton or limit its offerings to lower counts of yarn.*

In light of these findings, Esquel decided to limit its offerings to blended products (5% organic fibre), where the amount of organic fibre does not greatly affect the price or the physical characteristics of the yarn. For customers who wanted 100% organic cotton products, Esquel made sure the customer was willing to pay a premium for the product and offered only lower yarn counts.

This product mix allowed the company to expand its range of products without radically having to change its manufacturing processes or supply chains. But these offerings were sometimes not exactly what the customer wanted.

In most cases Esquel was able to explain to the customer the reason for those limitations. Then it worked with the customer to find a good compromise. In some cases, customers had to lower or change their standard to accommodate the use of organic cotton. This was partly because of the nature of organic cotton. However, most customers realized that if they wanted to commit to organic, they needed to be more flexible than with conventional cotton products. This is because they believe that, as buyers, they need to do their part to change the current agricultural practices.

At the same time Esquel continues to research and improve its spinning, weaving, knitting and finishing techniques to improve performance and value. The ultimate goal is to deliver products made with reasonably priced, high quality organic long staple and extra long staple cotton. However, this will take time and effort to develop. The biggest hurdle is actually achieving satisfactory yields and quality through organic farming.

At the end of the day, Esquel feels that customers are fully behind the organic cotton movement and are willing to support the development and expansion of the farming of organic cotton. However, farmers and other vendors in the value chain must do their part to educate customers on the advantages and limitations of their products. When there is open dialogue, Esquel has found that customers are quite willing to make compromises, and this will help to ensure a smooth increase in the supply of organic cotton. At the same time, customers will be expecting some improvements in the quality of organic cotton, and producers should work to deliver this.

Chapter 6

Market profiles

Bangladesh

The structure and characteristics of the domestic cotton market

The textile sector has emerged as a dominant player in the economic development of Bangladesh. The emergence and meteoric growth of the highly labour-intensive ready-made garments (RMG) sector in the last two-and-a-half decades significantly encouraged the development of the capital-intensive primary textile sector (PTS) in this country. In the financial year ending June 2006, Bangladesh's total exports amounted to \$10.526 billion, in which the contribution of the textile sector (comprising mainly RMG and knitwear) was \$8.10 billion, i.e. 77% of total national exports. Even in 2006, one year after all quota restrictions on imports of garments into the world market were removed, exports of RMG registered a growth of 21.6%.

Future market developments – demand and supply forecasts

The changing composition of RMG exports from Bangladesh in the recent years has created a steady demand for yarn and cotton in the local market. The share of knitwear in 2006 approached half of the total export of RMG, up from a meagre 10%–15% share in the early 1990s. This shift has taken place primarily because of two reasons: the necessity of establishing backward linkages to improve delivery response time for effective competitiveness; and the relatively small investment that is required to establish these linkages in the knitwear sector. Investments in composite knitwear manufacturing units have gained momentum in the last 8–10 years, creating substantial demand for good quality yarn and in turn demand for cotton for spinning.

Apart from the shift towards knitting that is boosting the development of the spinning sector, the RMG sector as a whole is also showing signs of positive future growth. This trend is likely to prompt further expansion of the spinning sector and in the process develop new markets for cotton.

The Government of Bangladesh has set export targets for the RMG sector up to 2008/09. While actual exports of textile and clothing (T&C) products in 2005/06 stood at \$8.10 billion, the targets for the subsequent three years have been set at \$8.87 billion, \$10.24 billion and \$12.06 billion respectively.

Supply and demand in the national market

Cotton spinning mills are the primary users of cotton. Therefore, any assessment of demand for cotton in the domestic market is dictated by the present size and future growth potential of the spinning sector. We shall

therefore look at the present status of the spinning industry in the country, its past growth pattern and the factors that may influence acceleration of this growth in the near future.

Growth history of the primary textile sector in Bangladesh

The private-sector-led growth of the PTS in Bangladesh is a relatively new phenomenon. In the spinning subsector, there were only 853,000 spindles in 1972/73, largely owned by the public sector. In the early 1990s, investment in private enterprises in this sector gained momentum and in the following 10 years capacity almost doubled, from 2,388,000 to 4,360,000 spindles. This growth gained impetus from the opportunities opened up by the then burgeoning RMG export sector.

Present status of the spinning sector

In July 2006, there were 237 spinning mills with 5.3 million installed spindles. Over 300,000 spindles were under installation and according to the Bangladesh Textile Mills Association (BTMA); another 1.4 million spindles were in the pipeline. Once all these spindles come into operation, there will be a quantum leap in the spinning capacity of the country. Growth in the previous two years had been 21%, from 4.4 million spindles in 2003/04 to 5.3 million in July 2006. According to BTMA, currently a new mill springs into operation almost every month. For denim production alone, BTMA estimated that the present 28 million metres produced in Bangladesh (July 2006) would go up to 180 million metres by the end of 2006, because of new investments that were taking place.

Yarn supply situation and future demand

Yarn production in Bangladesh is growing at the rate of 10–12% a year. In 2003/04, yarn production reached 380,000 tons. On a conservative estimate, this would mean that the country consumed almost 435,000 tons of cotton to produce that quantity of yarn.

However, USDA estimates that mill consumption of cotton increased from 375,000 tons in 2003/04, to 410,000 tons in 2004/05 and 480,000 tons in 2005/06 (August–July).

BTMA estimates that by 2008/09 the total demand for different types of yarn will reach 1.1 million tons, to meet both local demand and demand stemming from exports of RMG. Assuming that 70% of this yarn requirement would be produced in Bangladesh, the total requirement of cotton for the spinning industry would then be about 870,000 tons.

There is a shortage of spinning capacity in the country to supply the RMG sector. According to BTMA, in 2005 yarn requirements were around 1,040,000 tons (640,000 tons for export and 400,000 tons for the domestic market). Out of this, 550,000 tons were produced in Bangladesh. The gap of 490,000 tons is planned to be reduced through new investment in extra spinning mills. These mills, once set up, will consume another 300,000 tons of cotton within the next 2–3 years.

What kind of cotton is supplied from abroad, and from which countries?

Bangladesh has three main cotton market segments:

- *Cotton used to spin yarn in ring frames to be used for production of knit fabric for exports of knit garments.* This is by far the largest segment of the market for cotton, having about 55% of the total market share. This market segment has been created in recent years with dramatic development in the

composite knit garment sector. Companies in this sector buy yarns, knit their own fabrics, dyeing and finishing them according to the needs of their ultimate garment buyers, and sew and ship the finished garments direct to the chosen destinations of their buyers. This segment of market uses medium staple (1-3/32" to 1-1/8", or 27.8 mm to 28.6 mm) cotton imported mainly from Commonwealth of Independent States (CIS) countries, India and West Africa. The cotton used is of strict middling (SM) grade within the range 4.0–4.8 micronaire, having a minimum strength of 28.0 g/tex, a nep content of 180–240 neeps/g and a minimum maturity ratio of 0.90.

- *Cotton used to spin yarn in both ring and rotor frames for manufacture of woven fabric for the woven RMG sector.* This segment has about 15% of the market, and uses both medium (1-3/32" to 1-1/8", or 27.8 mm to 28.6 mm) and short staple (1-1/32" to 1-1/16", or 26.2 mm to 27.0 mm) cotton imported mainly from CIS, India, Pakistan and the United States. Specifications for medium staple cotton are similar to those above, whereas for short staple cotton the mills use middling (M) and strict low middling (SLM) grades within the range 4.2–5.2 micronaire, having a minimum strength of 26.0 g/tex, a nep content of 200–300 neeps/g and a minimum maturity ratio of 0.88.
- *Cotton used to spin yarn in both ring and rotor frames for the domestic markets for handloom products, saris and towels.* This segment has about 30% of the market, and uses long (1-5/16" to 1-7/16", or 33.3 mm to 36.5 mm), medium (1-3/32" to 1-1/8", or 27.8 mm to 28.6 mm) and short (1-1/32" to 1-1/16", or 26.2 mm to 27.0 mm) staple cotton imported from the United States (Pima), Sudan (Barakat), CIS, India, West Africa and Pakistan. Specifications for medium and short staples are similar to those described above; for long staple the mills use grade 2 cotton within the range 3.5–4.5 micronaire, having a minimum strength of 35 g/tex, nep content of 80–150 neeps/g and a minimum maturity ratio of 0.90.

Imports of cotton into Bangladesh

Bangladesh imported 370,000 tons of cotton of various grades in 2004. In 2005 this increased to about 650,000 tons. By 2010 Bangladesh will, according to BTMA, be importing over 870,000 tons.

Annual Import Payments 2004–2005, a publication of the Statistics Department of Bangladesh Bank, lists 89 countries to which payments were made for import of cotton. These payment statistics may not reflect the value of annual imports of cotton, as there could be a time lag between imports and payments. However, this is a good source of information about the supplying countries and a general indication of the volume of cotton coming from those countries. The statistics reveal that payments to 20 countries accounted for more than 90% of total import payments. Total import payments in 2004/05 were valued at about \$1.46 billion. The major suppliers were China, India, Uzbekistan and Hong Kong (China), accounting for about 57% of the total supplies.

It is interesting to note that cotton from as many as 23 African countries also found its way to the Bangladesh market, although the volume was not particularly significant. Sudan and Burkina Faso appeared in the list of top 20 supplying countries, accounting for 1.6% of the total import payments for cotton, while payment to the other 21 African countries accounted for only 3.2% of the total import payments for cotton.

Development of imports in the last five years

Official statistics available from Bangladesh Bank on imports of cotton and yarn show that in 2004/05 Bangladesh imported cotton valued at Taka 40,960 million (\$666 million) and cotton yarn worth Taka 24,140 million (\$392 million).

In the first 10 months of 2005/06, cotton imports amounted to Taka 39,570 million (\$596 million) and yarn imports Taka 27,010 million (\$407 million). The statistics reveal that there had been steady growth in imports of cotton and yarn over the last five years. Extrapolating from the figure for the first 10 months of 2005/06, for the whole year the growth in imports would be about 16%. In the previous three years imports grew by 19%, 51% and 27%. Imports of yarn also registered impressive growth, with 22% in 2003/04, 27% in 2004/05 and 34% (extrapolated for 12 months) in 2005/06. The increasing trend in the imports of yarn shows that the local spinning industry was unable to cope with the increasing demand for yarn.

USDA's estimates show an impressive growth in cotton imports:

Season (August–July)	Cotton imports (tons)
2000/01	220,000
2001/02	260,000
2002/03	350,000
2003/04	370,000
2004/05	400,000
2005/06	480,000

Prices

Prices are ruled by the international market. Offered prices are normally checked by the buyer with the international prices published on the Internet.

Cotton qualities supplied domestically

Bangladesh produces some cotton, though it cannot be termed a cotton-producing country. It has a Cotton Development Board (CDB), which operates under the Ministry of Agriculture. The quality of the domestic cotton is good according to some spinners but prices are higher than world prices.

Bangladesh grows two types of cotton: American Cotton and Comilla cotton or hill cotton. American cotton with a staple length of 1.125"–1.25" is cultivated in the south-western, northern and central regions of the country. The coarse and short staple length Comilla cotton, on the other hand, is grown in the hill districts.

Initiatives had previously been taken to encourage cultivation of cotton. Upland American cotton cultivation was initiated in the country in 1974/75 with the experimental introduction of an American variety (Deltapine-16) from the United States. Cotton cultivation in Bangladesh was given impetus in 1977 with a comprehensive cotton development programme at CDB. Since then CDB has released eight varieties: CB-1, CB-3, CB-5, CB-7, SI/91/646, SA/CB-1/99, JA/CB-5/99, and AVA.

Bangladesh has not achieved much in its efforts to develop cotton domestically. Cotton area is estimated between 40,000 and 50,000 hectares and production has been stagnating around 15,000 tons of lint since 2001/02. This is mainly due to the lack of irrigation, the long production time (6–7 months), low prices, and lack of seed production and supply, training and advisory services. Domestic production accounts for 3% of mill consumption.

Specific cotton quality requirements of the domestic textile industry

Domestic textile industries would prefer using quality benchmarks for different varieties of cotton so that buying decisions are made easy for them. They find the following standards to be appropriate for strict middling grade cotton of staple length 1 3/32":

- Micronaire*: Within 4.0–4.8.
- Colour*: Rd (diffuse reflectance) not less than 75.
- Nep content*: Less than 200 per gram.
- Strength*: More than 28 grams/tex.
- Length uniformity ratio*: Not less than 85%.
- Short fibre content*: Less than 5%.
- Seed count fragments*: Less than 15 per gram.

Source: Research based on interviews with Bangladeshi spinning mills.

Cotton import procedures in Bangladesh

The procedure for importing cotton into Bangladesh is fairly simple. The importer has to be registered with the Controller of Imports and Exports as an importer and must have an import registration certificate, generally known as an IRC, issued by the Office of the Controller of Imports and Exports. This certificate is renewable yearly on deposit of a renewal fee. In addition an import permit from the Ministry of Agriculture is needed; this is usually granted within three days without any difficulty. Only United States cotton needs to go through a fumigation process, because of the high use there of genetically modified cotton and chemicals. There is no customs duty on imports of cotton into Bangladesh.

The textile companies import cotton mostly through international trading houses. These traders have representatives in Dhaka, who act as indenter. The cotton-buying companies approach them giving their requirements and the indenters make them offers with full specifications and details on origin and prices. The long relationship between the buyers and these indenters functions very smoothly. Occasionally the indenters propose new cotton sources to buyers, including those from Africa. Hanif Spinning Mills for example has bought cotton from Zambia, upon the recommendation of Dunavant, an international trading house with representation in Bangladesh. Names of some of these local agents and indenters can be found at the end of this section.

Bangladeshi importers follow International Cotton Association (ICA) rules and contracts, with two exceptions. When importing from government companies in India, East India Cotton Association rules are followed. Imports from Egypt follow the Alexandria Cotton Rules. Payment is done through letter of credit.

Contract parameters mainly cover staple length, micronaire range and strength of the cotton. However, other considerations such as neps, trash content (i.e. contamination), sugar content and maturity, though not part of the contract, may cause serious difficulties. That is one reason why the importers prefer cotton from established sources, as they know exactly what is coming. Price is the main consideration for buying decisions although other parameters are also looked at.

Most yarn spinners in Bangladesh source around 70% of their cotton requirements from Central Asia, mainly Uzbekistan and Turkmenistan. Ten per cent of imports come from the United States, and the remaining 20% from India, Pakistan, the Syrian Arab Republic, Australia and various African countries. Yarn spinners receive advance fibre information measured using the HVI (High Volume Instrument) system.

All purchases are made through contracts to ensure clear and correct understanding between the buyer and seller on the following factors:

- ❑ Quality. Based on a sample or description of grade specifying range of staple length, micronaire range, Pressley range (a measure of strength), uniformity, percentage of short fibre, percentage of non-lint content, tolerable level of stickiness, etc.
- ❑ Percentage of sampling at destination.
- ❑ Procedure for settling disputes about quality or fulfilment of contract obligations.
- ❑ Responsibility regarding contamination or stickiness.
- ❑ Price in terms of currency, weight and place of delivery and shipment periods.
- ❑ Tolerances for weights and specifications.
- ❑ Port of shipment and port of destination, whether partial shipments are allowed or not, whether transshipment is allowed or not, whether shipment is to be in containers or break-bulk carriers.

Buyers in Bangladesh prefer to establish long-term relationships with a few agents who represent reputable trading companies in various cotton exporting countries.

Recommendations for LDC cotton exporters on increasing exports to Bangladesh

Africa has suffered from a bad image in relation to cotton imports in Bangladesh. Some manufacturers have had problems with on-time delivery, which disrupts internal planning and delivery of yarn. It is perceived that transport facilities within and from West Africa are insufficient to meet the on-time delivery needs of Bangladeshi spinners.

West African cotton has a reputation for high contamination and a high sugar content, both of which need to be reduced. Some mills have said that the level of contamination found in African cotton (especially from polypropylene) is much higher than that in cotton from Uzbekistan, for example. However, Zimbabwean cotton is regarded as having a low contamination level. An awareness programme is to be introduced for African cotton producers and spinners on the importance of reducing contamination.

Bangladeshi spinning mills have suggested that sub-Saharan African countries should develop and prepare an annual cotton buyer's guide (cotton importer's guide) along the lines of the guide produced by United States Cotton Incorporated. Bangladeshi mills use this guide extensively.

Spinners would like to see the cotton fields in order to develop a clear idea of the quality and the cotton characteristics.

Ensuring uniformity in the classification of cotton is essential to create confidence in buyers. Expert classifiers can manage to achieve a reasonable level of correct evaluation. However, with the availability of better instruments, it is always better to check qualities using instruments to make sure that the desired quality of cotton is established. African cotton producers must use sophisticated quality testing instruments to ensure the right quality. The High Volume Instrument (HVI) can measure all the necessary quality parameters in the same instrument, and it is generally recommended in lieu of individual testing instruments. Cotton quality and its parameters need to be communicated in advance to the spinning mills.

China

The structure and characteristics of the domestic cotton market: a macro view

Since 1999, with the development of China's textile industry, China has observed an annual increase of 20% in cotton consumption. By 2006, China had become the biggest cotton producer, consumer and importer in the world. It produced one-quarter of the world cotton yield; its annual consumption exceeded 9 million tons, being about one-third of the world's total cotton consumption; and import volumes reached 3.5 million tons, between a quarter and to a third of the world's annual import volume.

China's cotton holds a critical position in the world's cotton industry. In China, cotton is the second largest agricultural crop next to grain. The cotton industry is associated not only with the income of 200 million peasants, but also with the harmonious and healthy development of China's national economy.

Importance of cotton in Chinese textiles

China's cotton consumption is dynamic and constantly changing. In the 1960s, 1970s, 1980s and 1990s, the average annual cotton consumption was 1.6 million tons, 2.51 million tons, 3.85 million tons and 4.20 million tons respectively. The main reason for the slow growth in cotton consumption in the 1990s was that in the late 1990s China's whole textile industry experienced a

long period of loss and the quantity of cotton consumed dropped. In 1997, China's cotton consumption dropped to 3.14 million tons, while the amount of cotton consumed for textiles was only 3 million tons, the lowest since 1983. Since the beginning of the twenty-first century, China's cotton consumption has moved into a period of rapid growth. Cotton consumption increased from 5.33 million tons in 2000 to about 10.50 million tons in 2006; an annual average growth of nearly 10%. In view of the development prospects for China's textile industry, in the next few years, cotton consumption for textiles is likely to keep increasing.

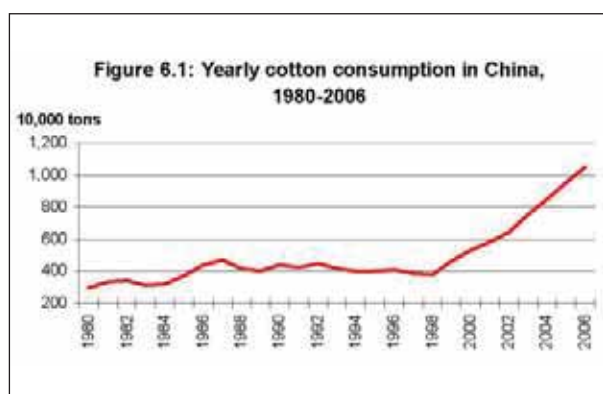

Domestic cotton

Cotton production is widely distributed in China, but over the last decades has changed from scattered plantations to more concentrated growth. Cotton plantations have shrunk in the areas not suitable for growing cotton, and cotton production is now mainly concentrated in more than 10 provinces of the 3 major regions: north-west inland, mid- and downstream of Changjiang (Yangtze) River, and Huang (Yellow) River. For the three major regions, the cotton yield shared respectively 35%, 30% and 35%.

Major problems for cotton production in China

High fluctuation. During 1995–2006, China's average cotton plantation area was 4.760 million hectares, with an annual average yield of 5.02 million tons. The biggest area was 5.69 million hectares (2004) and the smallest 3.726 million hectares (1999); a difference of 1.964 million hectares. The highest yield was 6.73 million tons (2006) and the lowest 3.83 million tons (1999), a

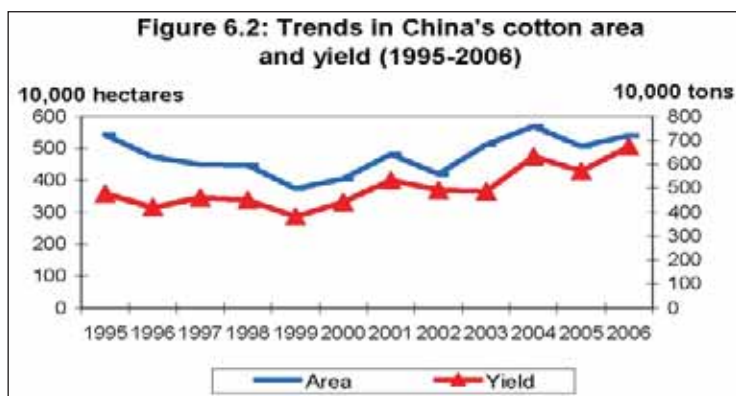

difference of 2.90 million tons (see figure 6.2). The fluctuation of China's cotton plantation area and yield has far exceeded that of the world's cotton area and yield. This places great pressure on China's cotton circulation, consumption and national macro control.

Cotton varieties. The varieties of cotton planted are various, mixed and complicated; the uniformity of seed supply is low and the varieties degenerate quickly.

Scale. There are few large-scale cotton growers. Cotton planting, field managing and seed cotton picking is basically done manually with low levels of mechanization, and labour-production ratio is not high.

Domestic cotton market

Since 1949 the domestic cotton market in China has experienced such operating mechanisms as free trading, centralized procurement and sale, contracted and ordered purchasing, and market economy under national macro control. Prices have been formed through free market, Government centralization of prices, and market-based pricing under national macro control.

From 1954 to 1998 China applied a system of centralized procurement and sale and contractual ordering of cotton. For the entire 45 years, procurement and selling prices for cotton were set by the central Government. The cotton price centrally formulated by the central government was in two parts: the procurement price and the selling price. The procurement price was the price paid to the cotton farmers by the procurement authority designated by the central Government (the jute and cotton companies at all levels under the All China Federation of Supply and Marketing Cooperatives) upon purchase of the cotton from the cotton farmers. The selling price was the cotton price at which the designated procurement authority sold the cotton to the textile enterprises. Whether procuring or selling, the price for different grades and lengths of cotton was specified by the central Government.

In 1999 the Chinese Government decided to open up cotton prices, cotton operation, and the cotton market. Cotton procurement and selling prices were then decided by the trading parties according to the market supply and demand. At the buyer market, cotton prices dropped, while at the seller market, cotton prices rose.

Mainly through the purchase and sale of reserved cotton, management of import and export quotas and other macro control policies, the Government controls the supply of and demand for cotton, and hence the price as well. The Government has cancelled all other policies controlling cotton production, while the China Agricultural Development

Bank competes on an equal footing with other commercial banks in terms of supplying the capital for cotton procurement and circulating.

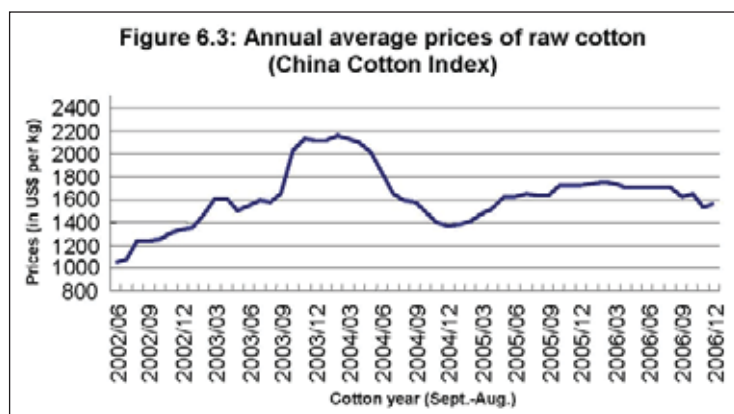

Quality of cotton produced and imported

In China's normal production season, the production of high quality cotton that could be used for producing high count yarn accounts for no more than 25%, with most of this produced in the Xinjiang region. Most inland cotton is of medium and low grade. High content of foreign matter is the main problem in domestic cotton; only Xinjiang cotton is free of this problem and for that reason the price of Xinjiang cotton is usually higher than that of inland cotton. With the increase in export of China's textile products, the demand for high quality cotton that can be used for high count yarn and low quality cotton under grade 5 that could be used for producing open end (OE) yarn have increased correspondingly. Of all

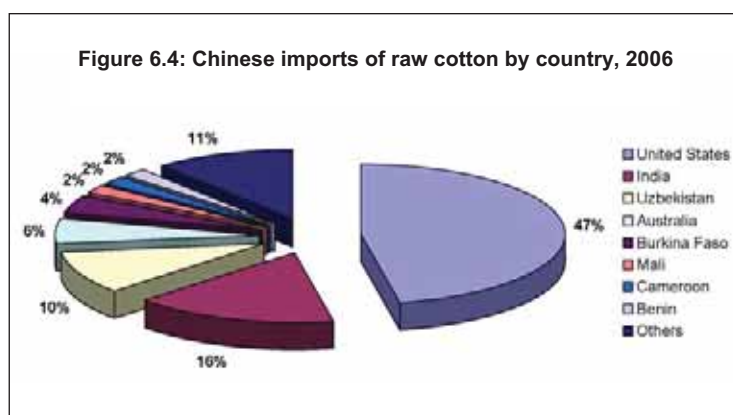

China's cotton imports, United States cotton now accounts for 47%, down from 60% in 2005. The market share of Indian and Uzbekistan cotton has also increased (see figure 6.4).

Supply and demand in the national market

The season for collecting seed cotton in China is from September to February. Seed cotton purchasers are ginneries, cotton vendors and cotton traders. Foreign companies are now allowed to procure seed cotton.

The volume of cotton used for textile consumption varies according to the season and the orders for textile products that mills receive. Usually April, May, September and October are the high months for cotton consumption. Because of the rapid increase in China's cotton imports in recent years, the Chinese Government uses a tariff-rate quota system to control cotton imports. Therefore, the quantity and timing of cotton imports in China are dependent on the quota quantity released by the Government at different phases of the year. Since 1999, when the Government opened up cotton trade, the Government no longer acts as the main player for cotton procurement. For macro control purposes, the Government set up the China National Cotton Reserves Corporation, which bears the task of purchasing and managing the national cotton reserve. The purchase of reserve cotton refers to the purchase of cotton lint, including domestic cotton and imported cotton.

Specific cotton quality requirements of the domestic textile industry

China's cotton consumption consists of textile consumption, batting wool and other cotton consumption. Batting wool is the cotton used for producing cotton quilts, cotton pads, cotton clothes, cotton shoes, cotton caps, cotton gloves, etc. Other cotton consumption includes medical cotton, military cotton and cotton for printing banknotes.

From the 1960s to mid 1990s, textile cotton was generally about 85% of total cotton consumption, batting wool about 12% and other cotton consumption about 3%. From the mid 1990s onwards, textile cotton rose from 85% to 95% of total cotton consumption, while that of batting wool and other cotton dropped below 5%.

Import developments

China is the biggest cotton producer and consumer in the world. However, in the early 1990s, China's cotton spinning industry developed relatively fast and China's cotton demand exceeded its supply, which caused a huge quantity of cotton to be imported. In 1994, China's cotton procurement caused the cotton futures price limit to rise continuously seven times on the New York Cotton Exchange. After 1995, China's annual cotton yield was kept stable, but because of the influence of the south-east Asian financial crisis, exports of cotton textile products dropped, China's consumption of textile cotton was reduced, and consequently the import volume dropped. Since 2000, exports of textile products have improved and the textile cotton volume has increased year by year. In 2006, China's cotton consumption reached 10.50 million tons, while the volume imported was 3.64 million tons.

Year	Consumption volume	Import volume	Ratio of imports to consumption
	(in millions of tons)		
2002	6.40	0.176	3%
2003	7.60	0.873	11%
2004	8.50	1.97	23%
2005	9.50	2.57	27%
2006	10.50	3.64	35%

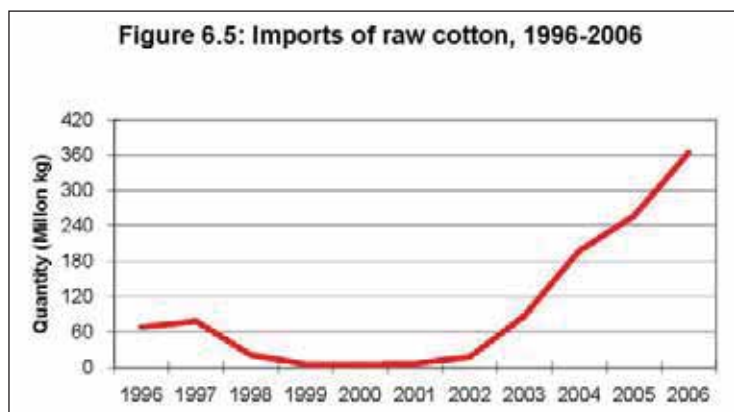

China's major cotton importing periods were during 1980–1983, 1989–1998, and in recent years. In 1980–1983, China imported in total 2.39 million tons of lint cotton, being over 17% of the total cotton supply for that period, with an annual average import of 600,000 tons. During 1989–1998, the rapid development of cotton spinning enterprises caused cotton consumption to exceed China's cotton yield and China's cotton supply became tight. Except for 1993, when the import volume was smaller, imports were high. During this period,

the total import of cotton was 4.43 million tons, with an annual average of 440,000 tons. In recent years, due to the fast growth of China's textile industry, cotton demand has increased sharply. It has been difficult for China's cotton production to meet the demand and cotton imports have greatly increased, amounting to 880,000 tons in 2003, 1.97 million tons in 2004, 2.57 million tons in 2005 and 3.64 million tons in 2006.

During China's planned economic period cotton imports and exports encountered the serious problem of 'selling low and buying high' due to delays in Government decision-making and lack of in-depth studies on the international market. When cotton prices on the international market were high, China imported a huge quantity of cotton. When international cotton prices dropped, a large quantity of cotton was exported. In 1995 China imported 663,000 tons of cotton, while the international cotton price reached

\$1.16 per pound; in 2000 China exported 293,000 tons of cotton, and the world cotton price (on the New York Futures Exchange) dropped to \$0.282 per pound on 26 October 2001.

Another reason for this mismatch was that the fluctuation in China's cotton supply and demand was far higher than the world average, with this fluctuation in China's cotton supply and demand in turn influencing the supply and demand of the international cotton market. Consequently, it directly caused the major rise and fall of international cotton market prices. In recent years,

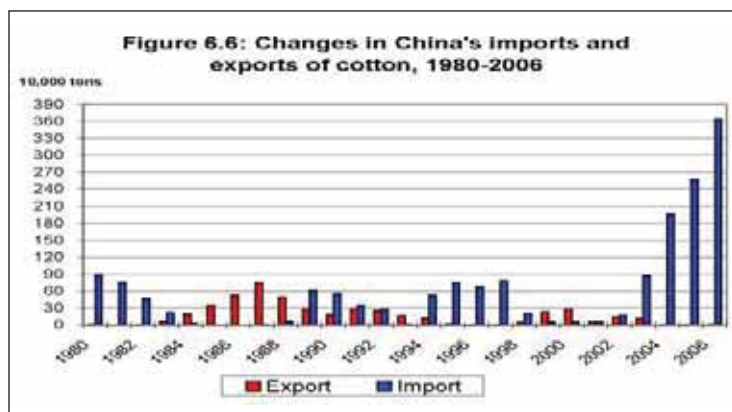

with the gradual internationalization of China's cotton market, the two markets and the two resources have gradually become integrated. China's cotton market has become an important component of the global cotton market, and the rise and fall of international cotton prices is no longer so closely associated with China's cotton supply and demand. International cotton supply and demand has become a leading factor influencing the global cotton price, including that of China.

Quota system and management of China's cotton industry

In 1998, the State Council of China issued the Decision on Promoting the Reform of Cotton Circulation System. (See the end of this section for a chronology of policies and events related to China's cotton import quotas.) With this decision, China's policy on cotton changed significantly towards a market mechanism under State macro adjustment. In conjunction with the concerned governmental institutions, the National Development and Reform Commission (NDRC) exerts its power to adjust the market in a macro way based on factors such as the cotton supply and demand situation, the cost of cotton production, the parity between cotton and grain, and the international cotton price.

At the beginning of each year, NDRC allocates quotas to applicants according to the number of applicants, historical actual import achievements, production capability and other relevant business standards of each applicant. In order to receive a quota, an enterprise must fit into one of four categories: State-owned trading enterprise; central enterprises with national reserve functions; enterprises with actual import achievements of general trade in the previous year; and cotton textile enterprises with over 50,000 spindles.

Before China initiated its cotton reform, cotton imports and exports were under the management of the China National Textiles Import and Export Corporation (Chinatex), affiliated to the former Ministry of Foreign Trade and Economic Cooperation. Cotton was traded according to the uniform price regulated by the State. After entering into WTO, China has gradually granted cotton import and export licenses to some qualified textile enterprises, cotton business enterprises and foreign trading enterprises, with the purpose of establishing and improving China's management system on cotton imports and exports and the tariff-rate quota management system. Since 2002, the cotton quota has been uniformly managed by NDRC.

Under the terms of its accession into the World Trade Organization, China was obliged to establish a calendar year tariff-rate quota with an in-quota tariff of 1% for agreed amounts of imports. Starting in 2003, in addition to these

'regular' annual tariff-rate quotas of 894,000 tons, China released additional quotas of 500,000, 700,000 or 1,000,000 tons once or twice a year. Higher sliding-scale duties applied to these additional quotas. In total, four quotas with sliding-scale tariffs between 500,000 and 1,000,000 tons were released between 2003 and 2005. In February 2006, an additional quota of a record 1.5 million tons with sliding-scale duty was released, and in April 2006 a special 200,000-ton quota was released for United States cotton (see table 6.3).

China's cotton imports have a significant influence on the international cotton price (see figure 6.7 for a comparison of the CC Index and the Cotlook A Index). Since 2003, the allocated cotton import quota has not satisfied domestic demand. In July 2003, for the first time, China added another 500,000 tons of cotton import quota, leading to a continuous surge to the daily limit on the New York Cotton Exchange. Since then, the Chinese Government has issued additional quota several times, but because of the time-lag between the official release of the news that China is adding to its quota and the actual issuance of quota, the market price usually declines rather than rises when the quota news is released. Exactly when NDRC will issue additional quota is uncertain as an internal clearance process needs to be followed, which involves the Ministry of Finance, the Ministry of Commerce, China National Textile and Apparel Council (CNTAC), the All China Federation of Supply and Marketing Cooperatives, the Ministry of Agriculture, the Agricultural Development Bank of China (ADBC), and finally reporting to the State Council and getting its approval.

On 30 April 2005, the General Administration of Customs of China announced that the tariff of the additional import quota issued in 2005 would be on a sliding tariff-rate basis. It regulated that for additional cotton import quota where the pre-tax price is higher than CNY 10,029 per ton, the tariff rate should be provisionally set at 5%; if the price is lower than CNY 10,029 per ton, a sliding tax rate ranging from 5% to 40% should be imposed according to a certain formula (see table 6.2). The reasons for the sliding tax are twofold. Firstly, it stabilizes the domestic cotton price, protecting the interests of domestic cotton farmers. Secondly, it gives an indirect impetus to the industrial upgrading of China's textile industry. The change of tariff rate results in increased costs for those textile enterprises importing low-grade cotton and decreased costs for those importing high-grade cotton, which encourages enterprises to import less low-grade cotton and improve the quality and grade of their textile products. This also encourages textile enterprises to turn to the production of high value-added products, in turn facilitating an internal reshuffle of the textile industry.

Table 6.2 Effects of sliding-rate tariff

Price (US\$/lb)	6%–40% tariff		5%–40% tariff		Price (US\$ per lb)	6%–40% tariff		5%–40% tariff	
	Rate (%)	Price after tariff	Rate (%)	Price after tariff		Rate (%)	Price after tariff	Rate (%)	Price after tariff
0.48	37.1	1665	27.7	1553	0.58	13.4	1664	13.6	1667
0.49	34.3	1665	25.9	1563	0.59	11.5	1665	12.5	1679
0.50	31.6	1665	24.3	1574	0.60	9.6	1664	11.5	1692
0.51	29.0	1665	22.7	1585	0.61	7.8	1664	10.5	1705
0.52	26.5	1664	21.2	1596	0.62	6.1	1664	9.6	1719
0.53	24.1	1664	19.8	1607	0.63	5.0	1674	8.7	1732
0.54	21.8	1664	18.4	1618	0.64	5.0	1700	7.9	1746
0.55	19.6	1664	17.1	1630	0.65	5.0	1726	7.1	1760
0.56	17.5	1665	15.9	1643	0.66	5.0	1761	6.3	1773

Note: The price after tariff is US\$ per ton, including 13% VAT and US\$ 5.65 per ton port fees.

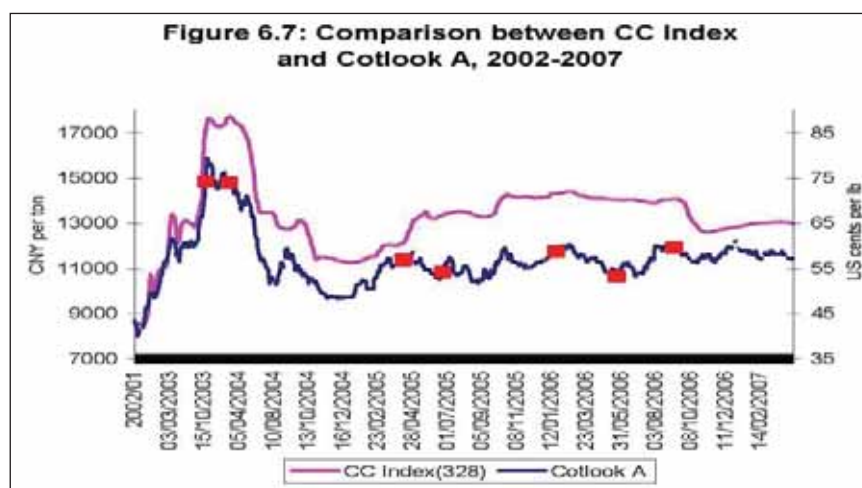

Table 6.3 China's cotton import quota issued and used, 2000–2006

Year	Original quota		Additional quota		Import total (10,000 tons)
	Quantity (10,000 tons)	Tariff rate	Quantity (10,000 tons)	Tariff rate	
2000	74.30	/	0	/	5.22
2001	77.80	3%	0	/	5.96
2002	81.85	1%	0	/	17.7
2003	85.625	1%	50	1%	87.36
2004	89.40	1%	100	1%	190.62
2005	89.40	1%	140	5–40%	257.36
2006	89.40	1%	150+20*+30** +70***	5–40%	364
Jan–Apr 2007	89.40	1%	150	6–40%	72.25

* The 200,000 ton quota released in 2006 was allocated to China's Five main State owned enterprises to purchase United States cotton during China's official visit to the United States.

** The 300,000 ton quota released in 2006 was for the purchase of United States cotton as China State reserve during China's official visit to the United States.

*** The 700,000 ton quota released in 2006 was matched with the purchase of Xinjiang cotton at the ratio of 1:1.

Non-tariff requirements in the domestic market

Customs procedures

Upon arrival of imported cotton, the importer normally entrusts a professional clearing agency with the declaration to Customs. The agency should first apply to Customs for quarantine and inspection. If any plant diseases or insect pests are observed in the goods during quarantine, measures shall be taken to eradicate them. At the end of the quarantine period, Customs issues a customs clearance note indicating that quarantine has been completed. Next, the clearing agent needs to complete the customs declaration and submit it to Customs along with the full customs documents. Once the documents have been checked, Customs will calculate the tariff and VAT for the goods; when the relevant tax has been paid, the clearing agent can collect the corresponding tax invoice and the customs declaration issued by Customs recording the details of the goods. Then the goods will be released.

In recent years, more and more international cotton merchants have been exporting cotton to China via consignment in bonded warehouses, which

occurs in the following way. Overseas merchants ship the cotton to China's port, undertake the quarantine and submit the first customs declaration for the bonded warehouse, without paying the tariff. If the client is satisfied with the cotton quality upon checking it at the bonded warehouse and decides to buy the cargo, a second customs declaration is completed. The tariff is then paid by the client according to the quantity and price of the cotton, and the goods are released from the bonded warehouse. The entire process is basically consistent with the general trade system described above.

Freight forwarding and transport requirements

Almost all imported cotton is shipped to coastal ports, and the textile enterprises sign contracts on a cost including freight (CIF) basis. In China, the main regions consuming imported cotton are concentrated around the three ports of Shanghai, Qingdao and Tianjin. In addition, a small quantity of Uzbekistan cotton is transported through the Europe–Asia railways to inland China. This process is complicated, so although it takes a shorter time and costs less to transport the cotton overland, most Uzbekistan cotton is still shipped to China's sea ports. Upon taking delivery at the port, most textile enterprises transport the cotton to their factories by road; a few textile enterprises that are far away from the ports also use rail transport.

Packaging, marketing, labelling and specific domestic business practices

According to the Chinatex Contract Terms for Cotton Purchase, there are two main types of packing included: single and group. The contract specifies that cotton packing should be outside packaging, covered with gunny cloth, cotton cloth or other wrappers, suitable for marine shipment, which should be tightened with steel baling straps or iron wire. If the gross weight per ton exceeds the specified volume, the seller pays the freight for the exceeded portion. The cotton bales shall not be allowed to mix with any hemp thread, rags, sawdust, iron scurf or iron nails, or other specified substances. If this is found, the buyer can claim against the seller for the damage according to the findings made by China Entry-Exit Inspection and Quarantine (CIQ) or certification provided by the user.

Shipping marks are printed on one end or two sides of the cotton bale with non-fading paint one by one. The seller is responsible for the expenses of changing mixed-mark goods due to the seller's failure to print the contract number.

Specific contract requirements

Chinese enterprises have developed some conventions for the import of cotton. The main features are listed here.

- ❑ **Definition of contractual variety.** In China, the signed contract for cotton import has three ways of stipulating the quality: transaction as fixed standard; transaction as per sample; and transaction as per physical goods, which has become increasingly popular in China as consignment trading has grown in recent years (i.e. foreign cotton dealers store the cotton in China's bonded warehouses, the buyers inspect the goods at the bonded warehouse before making a deal, and thus there is no claim against the quality).
- ❑ **Price terms.** China's cotton importers prefer to adopt CIF price terms, in which the seller pays for shipping and bears the cost of freight. Very few import contracts adopt FOB terms.

- ❑ **Fixation of contractual price.** Chinese enterprises are used to signing fixed-price contracts. Since few Chinese cotton buyers hedge their cotton on the New York Cotton Futures Exchange, they seldom use overnight firm bids, seller's on call or buyer's on call to define the contract price.
- ❑ **Final settlement.** China's import cotton mostly adopts landed quality and weight, i.e. final settlement is subject to quality inspection and a weight authentication certificate issued at the port of arrival. However, to import Egyptian cotton, China adopts the Alexander Terms, which take the quality and weight verified by the local Cotton Arbitration and Testing General Organization (CATGO) as the final basis.
- ❑ **Contract terms.** The contractual terms are mostly based on Chinatex Contract Terms for Cotton Purchase, without using the Liverpool Contract or ACSA Contract (see below).

Chinatex Contract Terms for Cotton Purchase

The Chinatex Contract for Cotton Purchase has the following key points.

- ❑ In claims regarding delayed issue of L/C and shipment, the defaulter pays compensation at 1.25% per month of the contract price.
- ❑ Landed inspection by CIQ is taken as final, including:
 - **Weight.** At the destination port CIQ takes random samples of 5% for testing moisture regain, and weigh each bale before issuing the weight certificate. The allowable moisture regain is 8.5%; any excess will be deducted, and percentages below this will not be made up (to restrict the moisture regain).
 - **Tare.** CIQ samples 3%–5% of the bales for each batch of goods in order to define the average tare. The net delivery weight is calculated based on the actual average tare.
 - **Tolerance.** The tolerance for the delivery weight for each contract shall not be more than 1% of the contractual quantity. If the New York market price upon shipment is higher than the New York market price upon signing the contract, the extra portion will be counted as per the contract price. For short delivery by less than 1%, the buyer has the right to claim from the seller for the price difference and loss due to the dead freight, referring to the FOB or FAS (free alongside ship) terms. If the New York market price upon shipping is higher than the New York market price upon signing the contract, if the extra delivery exceeds 1%, the buyer has the right to claim from the seller for the price difference.
 - **Quality:** A random sample of 10% (strength 5%) is taken from each batch as the base for inspecting the quality. If certain samples of the deliveries are lower than the specified range of the contractual grade, length, strength or fineness, the inspection certificate issued by CIQ shall become the base for the two parties to settle the account.
- ❑ **Inspection fees.** The seller will undertake the inspection fee for weight, at 50 cents per bale. If the seller proposes re-inspection for moisture regain, the seller will undertake the sample expenses at 80 cents for each bale, and US\$ 2.00 for water-content testing. Quality inspection fees will be borne by the buyer, at a rate of US\$ 1.00 per bale, or US\$ 10.00 per sample. If the quality is degraded, the seller should cover the inspection fees for the substandard portion, at US\$ 5.00 for the grade or length of each sample, \$0.75 per micronaire value, and US\$ 2.00 per Pressley.
- ❑ **Eradication of plant disease and insect pests.** The cotton delivered by the seller shall not be allowed to contain any plant disease or insect pest

specified by the national quarantine authority. If any aforementioned plant disease and insect pest is observed upon delivery, all the expenses arising from the extermination will be borne by the seller, except for the loss of original carriage period to be undertaken by the buyer.

- **Documentation.** Requirements vary depending on the exporting country, but the basic documents include: invoice, bill of lading, plant quarantine certificate, quality certificate, certificate of origin, simple packing list, detailed specification of weight, and non-wood packing certificate.

Expected market developments

During the period 2002–2006, China's textile cotton demand observed an average growth of 15%. In 2007 China's cotton consumption is likely to exceed 10 million tons. China's cotton yield has observed large fluctuations over a long period of time, mainly because fluctuations in market price directly affect planted acreage from year to year. In the 2006/07 crop year, China's cotton production reached 6.73 million tons, setting a new historical record. Since China's cotton and grains compete for land, further growth in cotton plantation is limited. Therefore, in the long term, China's supply–demand imbalance will continue, *and annual cotton imports are likely to exceed 4 million tons*. China's cotton stockpiling structure has changed with the introduction of governmental macro control in recent years and changes in the way cotton is imported into China. In addition to the normal commercial and industrial stockpiling, national reserved cotton and imported cotton stocked by consignment at ports are also available for China's textile cotton consumption.

The domestic market: a micro view

Different players in the market

China's cotton market players include cotton farmers, buyers, ginneries, domestic traders, international traders and spinning mills. There is no strict work division between them. 'Buyers' means the cotton dealers, i.e., those who buy the seed cotton from the cotton farmers for selling to ginneries. With bank loans, many Chinese traders also directly participate in purchasing and processing. Additionally, according to the protocol for joining WTO, after 1 January 2003, China has allowed foreign cotton traders to undertake domestic cotton procurement, processing and operation in China. Currently, some international traders are allowed to undertake domestic cotton trade in China. In China, some large textile mills are also directly involved in cotton procurement and cotton ginning.

Specific cotton contracts

When purchasing cotton, Chinese textile mills may have different purchase conventions according to their differing circumstances. For example, many small textile mills have comparatively scattered purchase channels, and as most of these mills cannot obtain import quota, they seldom use imported cotton. Conversely, comparatively large enterprises normally relatively fixed cotton suppliers.

For the domestic purchase and sale of cotton in China, there is no fixed contract format, but the general contract conditions include quality specification, price explanation, payment mode, claim against quality, and shipment terms. For cotton trade between most small enterprises, oral agreement is made for trading. For cotton purchase and sale, large enterprises have their own fixed format. For commercial cotton dealt with at the China National Cotton Exchange, an electronic contract is adopted.

Cotton finance and payment regulations

Before 1999, cotton purchase and sale loans were provided by the central Government through the China Agricultural Development Bank. Since 1999, when the market was opened, other commercial banks have also been able to provide loans for cotton purchase and sale. The China Agricultural Development Bank currently shares 50% of the loans for cotton purchase and sale. Most of the cotton circulation enterprises still obtain bank loans against warrants: i.e. they keep the cotton in a warehouse designated by the bank to obtain the loan. China National Cotton Exchange (CNCE) has over 90 designated warehouses all over China, in cooperation with various commercial banks providing cotton trade enterprises with such financial services.

Use of e-commerce and ICT for procurement

Within three years from 2000, when the Government started to sell commercial cotton through the CNCE, the Government held online auctions for nearly 4 million tons of cotton. From the end of 2002, the CNCE also introduced also an e-matching trade of commercial cotton (mid- and long-term spot exchange). Currently, in China, nearly one thousand cotton traders and textile enterprises participate in this form of trading for cotton procurement and sale. The cotton acquired and reserved under the Government's macro control all goes through online selling or buying bids.

Consumer preference for specific fibre types and blending

According to their spinning capacity and their product varieties, Chinese textile enterprises have different cotton preferences. Most textile mills spinning fine yarns (40s and above) prefer cotton from Xinjiang, which has good quality and contains little contamination. However, the long shipment distance and high price is a disadvantage for Xinjiang cotton. Of all the imported cotton, United States cotton has held the leading position, mainly because it contains less contamination than other cottons. When textile mills encounter contamination problems their labour costs are increased by approximately 1.5 cents per pound, as they have to employ additional staff to manually remove this foreign matter from the cotton.

Shandong Weiqiao Pioneering Group: case study of a large national cotton consumer

Shandong Weiqiao Pioneering Group Co. Ltd is one of the super-large comprehensive cotton textile enterprises in China, with its spinning capacity ranking first in Asia. It primarily produces different types of cotton yarn, grey cloth and denim. In 2006, its output reached 882,000 tons of cotton yarn, 1.634 billion metres of grey cloth and 175 million metres of denim.

The enterprise's annual cotton consumption is about 900,000 tons, of which more than one-third is imported cotton. As to the cotton varieties purchased, Shandong Weiqiao normally refers to the order of downstream products and carries out its procurement of cotton with different grades, quality and spinnability based on product orders. It procures cotton in two ways: 1) consigned procurement (i.e. it entrusts some Chinese large cotton enterprises with specific-quantity procurement through their nationwide procurement system); 2) fixed acquisition stations in the major cotton production regions such as Shandong, Hebei and Henan, to which it releases a desired acquisition price each day at a fixed time. Cotton ginning enterprises or circulating enterprises which accept this price can deliver cotton to these stations at any time. In terms of imported cotton, in recent years it has mainly selected cotton from India, Uzbekistan, the United States, and West Africa. It mainly cooperates with the representative offices of international cotton traders with a

good reputation in China for the procurement of different origins and varieties. Because it is so large, the procurement prices released by Shandong Weiqiao are normally lower than the market price. Additionally, Shandong Weiqiao will select reputable large trading enterprises for cooperation in purchasing domestic cotton as well as in importing cotton.

As for how to reach an agreement with this giant and other large companies, it is suggested that new cotton dealers should first of all make sure of their cotton standards and spinnability and provide the textile enterprises with detailed data. It is better to provide the textile enterprises with cotton samples for testing or keep a small quantity of goods at China ports for enterprises to inspect. Stability of cotton quality and company credibility are also very important factors for long-term cooperation.

Possible niche markets and product groups to be targeted

Short linters and cotton waste are the main materials used in producing OE yarn and cotton slurry. The development of China's textile industry has speed not only the consumption of cotton, but also the consumption

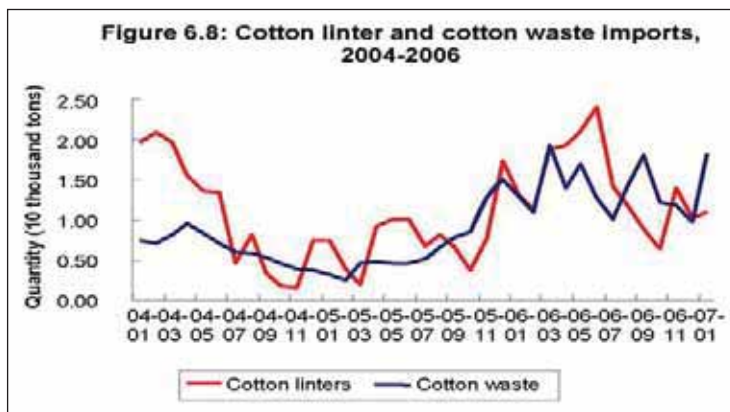

of cotton linters, cotton waste and comber noil as shown in figure 6.8. According to Customs statistics, in 2005 Chinese imports of cotton linter and cotton waste were 90.28 thousand tons and 80.3 thousand tons respectively. In 2006, imports were 170.38 thousand tons and 163.7 thousand tons, an increase of 87% and 103%. There is a tariff of 10% on imports of short linters and cotton waste, while imports are quota-free. Since China has no national uniform standard for short linters and cotton waste, such imports are mainly contracted on the basis of samples.

The price of imported short linters and cotton waste enjoys a big advantage over that of China domestic short linters and cotton waste; hence this business is very lucrative.

Recommendations for LDC cotton exporters for penetrating the Chinese market

With the increase in imported cotton consumed by Chinese textile mills, more and more African cotton has entered China. It did, however, take some time for Chinese textile enterprises to accept African cotton. Chinese textile mills generally perceive African cotton to be of good quality at a comparatively low price. It is suggested that for African cotton, organized and large-scale marketing should be carried out in China. Standards of African cotton need to be made uniform, and the transaction mode of depending purely on samples for export should be changed. Additionally, efforts should be made to tighten management of the cotton ginning process to avoid the problem of 'three thread' (chemical fibre, hemp thread and hair) and mixed grades.

The consignment method of trading is well accepted by Chinese textile enterprises and should be adopted where possible. In China, bonded consignment has become one of the important modes in cotton import, and has been undertaken by almost all big international cotton traders.

Before entering the Chinese market, exporters need to make sure they understand China's macro control policies for cotton. Currently, China's cotton policy is following a market mechanism under the Government's macro

control, including State reserve, tariff-rate quotas and policy loans. Market control has an important influence over China's cotton price and even the world's cotton price. Therefore, it is extremely important to well understand China's relevant cotton policy so as to understand desired market direction.

In recent years, the Chinese Government has paid much attention to helping African LDCs enter into China's market. Each year, the Ministry of Commerce holds several seminars or training programmes especially for African LDCs, to guide them on how to gain access to China's big market. Cotton typically plays a very import part in such seminars or programmes.

Every two years, there is an International Cotton Conference jointly hosted by the Ministry of Agriculture, FAL and CNCE. This very large cotton event attracts nearly a thousand participants from the cotton industry all over the world. African cotton-producing countries can also take advantage of this opportunity in accessing China's large cotton market.

Detailed rules for quota management of cotton imports in China

Name	Programme
Institution to distribute and issue quota	The National Development and Reform Commission (NDRC) and the Ministry of Commerce.
Time to apply for the tariff rate quota	Between 15 and 30 October of the preceding year.
Valid period of the tariff rate quota	Beginning of January to end February of the next year.
Who can apply for the tariff-rate quota?	<ol style="list-style-type: none"> 1. State-owned trading enterprise; 2. Central enterprises with national reserve functions; 3. Enterprise with actual import achievements in the previous year; 4. Cotton textile mills with over 50,000 spindles.
Institutions issuing the quota	Institutions authorized by NDRC.
Distribution principles for the quantity of tariff rate quota	<ol style="list-style-type: none"> 1. If the quantity for distribution is less than or equal to the total quantity applied for: <ul style="list-style-type: none"> • Distribute according to the quantity applied for, historical actual import achievements, the production capacity of the applicant, and other business standards. 2. If the quantity for distribution exceeds the total quantity applied for: <ul style="list-style-type: none"> • Applicants with actual import achievements have priority. • For applicants without previous import performance, the quota is distributed proportionally according to production capacity. • If the quantity applied for is less than the quantity that would be distributed proportionally, distribution shall accord with the quantity applied for. • The minimal distribution quantity is determined according to commercially workable shipping volumes.
Redistribution of tariff-rate quota	<ol style="list-style-type: none"> 1. Unused quota shall be returned before 15 September of that year. 2. Other applicants can submit redistribution applications between 1 and 15 September; the results will be released before 1 October. 3. For those who do not return unused quota, their quota will be reduced accordingly during the quota distribution of the next year.

For those who get the tariff-rate quota qualifications of cotton import	Issue the <i>Certificate of the Import Tariff-Rate Quotas of Agricultural Products</i> stamped with the Special Seal of Certificate of the Import Tariff-Rate Quotas of Agricultural Products.
Use of the tariff-rate quota certificate	<ol style="list-style-type: none"> 1. The certificate is applicable to imports in general trade, processing trade, barter trade, small amounts of border trade, or assistance from abroad. 2. A license is not required for products entering bonded warehouses, free trade zones and export processing areas from abroad. 3. For agricultural products with tariff-rate quota imported from bonded warehouses, free trade zones and export processing areas, Customs shall handle the import formalities by virtue of the Certificate of the Import Tariff-Rate Quotas of Agricultural Products according to the concerned import goods management. 4. Under the ‘multi-lot one-certificate’ system, customs clearance formalities can be handled many times. 5. The over-shipped volume for each lot of the bulk cargo shall not exceed 5% of the lot.
Return of the tariff rate quota certificate	<ol style="list-style-type: none"> 1. Those who have exhausted their quotas shall return the original copy of the first sheet (the Sheet of Consignee to Handle the Customs Formalities) of the Certificate of the Import Tariff-Rate Quotas of Agricultural Products to the issue institution within 20 business days after the last lot of cargo is presented to Customs; otherwise it is deemed that the quota is uncompleted. 2. Those who have not exhausted the quota shall return the first sheet (the Sheet of Consignee to Handle the Customs Formalities) of the Certificate of the Import Tariff Rate Quotas of Agricultural Products to the issuing institution prior to the end of January of the next year.
State-owned trading enterprises entitled to the quantity distribution of tariff-rate quota	<p>Six State-owned trading enterprises are entitled to import cotton. They are as follows:</p> <ol style="list-style-type: none"> 1. Chinatex. 2. Beijing Jiuda Textile Corporation. 3. Tianjin Textile Industrial Supply and Sale Company. 4. Shanghai Textile Raw Materials Co. Ltd. 5. China National Cotton Reserves Corporation. 6. Xinjiang Nongken Import and Export Co. Ltd.

Chronology of policies and events related to China’s cotton import quota

Time	Event
11 December 2001	<i>Catalogue of Goods Subject to the Management of Import Tariff Rate Quota</i> was issued by the former Foreign Trade Commission.
Early 2002	The former National Development and Planning Commission (NDPC) promulgated the <i>Interim Measures for the Administration of Import Quotas of Agricultural Products</i> , which regulated that the cotton import tariff-rate quota should be subject to the uniform management of the former NDPC.
7 February 2002	<p>NDPC issued the Quantity of Import Tariff Rate Quotas, Application Conditions and Distribution Principles of Key Agricultural Products in 2002, which regulated that the tariff-rate quota for cotton imports should be 818,500 tons. The quota is divided into two types, A and B, which can be applied for by enterprises fitting into one of the following categories:</p> <ul style="list-style-type: none"> • State-owned trading enterprise; • Central enterprises with national reserve functions; • Enterprise with actual import achievements of general trade in 2001; • Cotton textile enterprise with over 50,000 spindles.

9 August 2002	NDPC issued the Notice on Redistributing the Import Tariff Rate Quotas for Major Agricultural Products in 2002.
30 September 2002	NDPC issued the Quantity of Import Tariff Rate Quotas, Application Conditions and Distribution Principals of Key Agricultural Products in 2003, which stipulated that the import quota of cotton should be 856,250 tons.
2 January 2003	NDPC issued 2003 import quotas of agricultural products; the tariff-rate quota for cotton imports was set at 856,250 tons.
28 March 2003	China National Cotton Reserves Corporation (CNCRC) was officially incorporated in Beijing. CNCRC, a State-funded corporation approved and entrusted by the State Council, is in charge of the operation and management of national cotton reserves.
31 July 2003	The Ministry of Commerce and NDRC jointly issued the Interim Measures for the Administration of Import Quotas of Agriculture Products (Draft for Comment), which regulated that issuances related to cotton import quotas would be managed jointly by the Ministry of Commerce and NDRC, and the tariff-rate import quota for cotton would be publicized by NDRC. It also removed the division into A and B categories on tariff-rate quota certificates and specified that processing trade enterprises wanting to import should submit a processing trade business licence as well as the tariff rate quota certificate.
11 August 2003	The Ministry of Commerce and NDRC issued the <i>Notice on Redistributing the Import Tariff Rate Quotas of Agricultural Products in 2003</i> .
27 September 2003	The Ministry of Commerce and NDRC distributed the <i>Interim Measures for the Administration of Import Quotas of Agriculture Products</i> , affirmed the regulations in the Draft for Comment, and regulated that the valid period of the tariff-rate quota certificate could extend to the end of February of the next year.
30 September 2003	NDRC issued the <i>Quantity of Import Tariff Rate Quotas, Application Conditions and Distribution Principles for Grains and Cotton in 2004</i> , which set the tariff-rate cotton import quota at 894,000 tons. Article 2 in the application conditions, 'Central Enterprise with National Reserve Functions', was eliminated.
Early November 2003	NDRC stated that it would issue an additional 500 000 tons of cotton import quota at a tariff rate of 1% before 31 December of that year.
12 December 2003	NDRC issued a notice extending the valid period of 2003 tariff rate quota certificates for cotton imports from the original 31 December 2003 to 30 June 2004.
30 December 2003	NDRC announced that the tariff-rate quota for cotton import in 2004 would be 894,000 tons.
End of February 2004	NDRC issued an additional cotton import tariff-rate quota of 1 million tons at the tariff rate of 1%.
4 March 2004	The additional 1 million tons of cotton import quota was distributed to the concerned economic and trade commissions and cotton textile enterprises.
11 August 2004	The Ministry of Commerce and NDRC jointly issued the Notice on Redistributing the Import Tariff Rate Quotas of Agricultural Products in 2004 .
30 September 2004	NDRC issued the Quantity of Import Tariff Rate Quotas, Application Conditions and Distribution Principals of Grains and Cotton in 2005 .
30 April 2005	NDRC and the General Administration of Customs in China issued the <i>Notice on 2005 Cotton Import Beyond the Tariff Rate Quota</i> , which for the first time put forward the concept of sliding tariffs and issued additional an 1.4 million tons of cotton quota, beyond the tariff-rate quota, in two lots.
22 July 2005	NDRC distributed the remaining 700,000 tons of cotton import quota beyond the tariff-rate quota.
15 August 2005	The Ministry of Commerce and NDRC issued the <i>Notice on Redistributing the Import Tariff Rate Quotas of Major Agricultural Products in 2005</i> .

13 September 2005	NDRC issued the <i>Quantity of Import Tariff Rate Quotas, Application Conditions and Distribution Principals of Grains and Cotton in 2006</i> .
27 December 2005	The General Administration of Customs promulgated the <i>Scheme of 2006 on Imposing Sliding Tariff on Imported Cotton beyond the Tariff Rate Quota</i> , which increased the pre-tariff price of imported cotton from CNY 10,029 per ton to CNY 10,746 per ton.
4 January 2006	NDRC distributed 894,000 tons of tariff-rate quota for cotton imports.
11 January 2006	An additional 1.5 millions tons of cotton import quota beyond the tariff-rate quota was issued.
6 April 2006	Wu Yi, Vice Premier of the State Council, struck a deal worth US\$ 4 billion with American companies in Los Angeles, including 500,000 tons of United States cotton procurement, among which 200,000 tons was distributed to the five State-owned large enterprises and the remaining 300,000 tons was for national reserve.
24 May 2006	It was shown that the 1.5 million tons of cotton import quota beyond the tariff-rate quota had been distributed all at once.
5 July - 31 August 2006	To facilitate the sale of Xinjiang cotton, the State practised a tie-in sales policy fixing the ratio of cotton import quota to Xinjiang cotton at 1:1.
18 September 2006	NDRC issued the <i>Quantity of Import Tariff Rate Quotas, Application Conditions and Distribution Principals of Grains and Cotton in 2007</i> .
30 September 2006	The 700,000 tons of cotton import quota matched with the purchase of Xinjiang cotton at a proportion of 1:1 was distributed to the concerned textile enterprises. The valid period of the tariff-rate quota certificate was up to 31 December 2006.
28 December 2006	The Customs Tariff Commission of the State Council issued the <i>2007 Implementation Scheme on Customs Tariff</i> , which raised the sliding tax cut-off point on the pre-tariff price from CNY 10,746 per ton to CNY 11,397 per ton and eliminated the so called 'floor CIF for imported cotton'. The benchmark tariff rate was raised from the original 5% to 6%, and a sliding tax scheme of 6%–40% was in force.
31 December 2006	NDRC began to distribute the 894,000 tons of tariff-rate quota for cotton import for 2007.

India

The structure and characteristics of the domestic cotton market

Importance of cotton in Indian textiles

The Indian textile industry is predominantly cotton based. In contrast to worldwide textile consumption, which is tilted heavily in favour of non-cotton fibres with ratio of 40:60 'cotton' to 'non-cotton' fibres, consumption in India is 60:40 in favour of cotton. The current size of the Indian textiles industry is estimated to be \$47 billion per year, and growing at 20% per year. Since the phasing out of the quota regime, Indian exports have grown by 26% compared to the previous year's total of \$13 billion. The overall mood in the textile sector is upbeat.

National cotton production

India is the third largest producer of cotton in the world, but in terms of productivity it is one of the lowest. The average area under cotton production has varied from 8.7 million hectares in 2001/02 to 8.8 million hectares in 2005/06. Production during the same period has increased from 2.686 million tons to 4.148 million tons. The average yield of Indian cotton, which was 307 kg per hectare in 2001/02, had improved to 468 kg per hectare in 2005/06.

The supply and demand for cotton, and the area, production and productivity of cotton in India for the last five years as estimated by the Cotton Advisory Board are shown in figures 6.9 and 6.10.

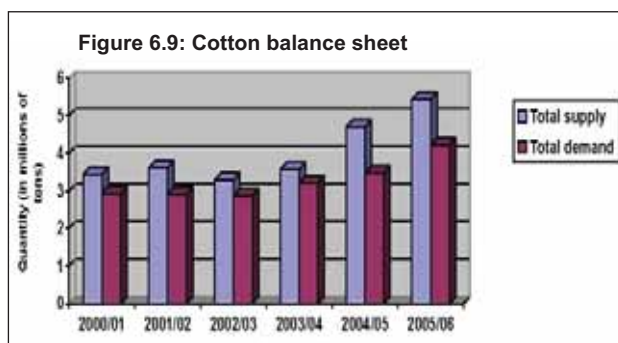

Source: Cotton Advisory Board, Government of India.

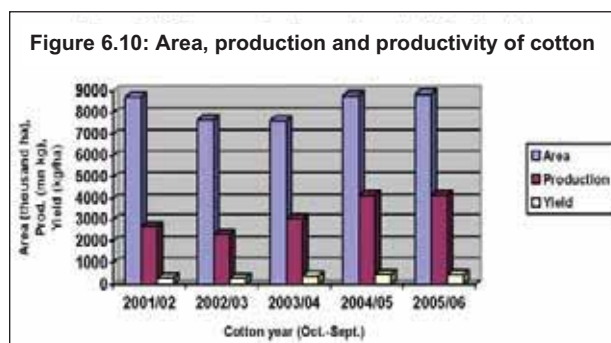

Source: Cotton Advisory Board, Government of India.

The domestic cotton market

The domestic cotton market has been fully integrated with the international market for the past five or six years, and domestic prices move in tandem with international prices. Prior to 1997, domestic cotton prices used to register some increase every year but were still lower than international prices. However, since 1997/98, the world cotton scenario has undergone a change in which international prices nose-dived to their lowest levels especially in 1999/00. World prices had a cascading effect on domestic prices, and large-scale imports were witnessed during this period mainly because of price considerations. Again in 2004/05 because there was record world production, international cotton prices declined. A similar situation was witnessed in the domestic market too, as the country had harvested a record cotton production of 4.15 million tons. The current level of imports ranges between 85,000 and 100,000 tons per year, confined to extra-long staple cotton, and imports may continue to increase in the coming years. The movement of average annual prices of seed and lint cotton is shown in figures 6.11 and 6.12.

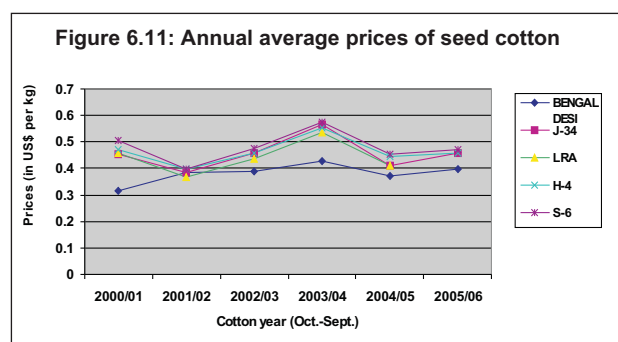

Source: Cotton Advisory Board, Government of India.

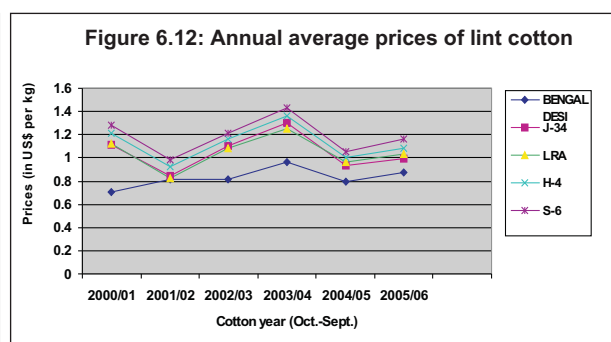

Source: Cotton Advisory Board, Government of India.

Quality of cotton supplied by the domestic industry, and imports

India has the distinction of producing a number of cotton varieties, comprising short staple, medium long staple, long staple and extra-long staple (ELS) cottons, to meet the specific quality requirements of the domestic textile industry. The major varieties grown and commercially marketed in India are Bengal Deshi, V-797, Jayadhar, Y-1, J-34 Saw Ginned, NHH-44, LRA, H-4/MECH 1, Shanker 6, Bunny/Brahma, MCU 5, DCH-32 and Suvin. DCH-32, MCU-5/Surabhi, and Suvin are ELS varieties grown in India. While

the country is self-sufficient in general cotton varieties, the production of ELS varieties has remained deficient because of fluctuating production in comparison with increased consumption of ELS cotton. To meet specific requirements for ELS varieties, textile mills import cotton, especially from the United States (pima) and Egypt (Giza).

There has been a downward trend in imports of cotton because domestic production has increased. Imports of raw cotton from 2001/02 to 2004/05, and imports by country for year 2004/05 are shown in figures 6.13 and 6.14 respectively.

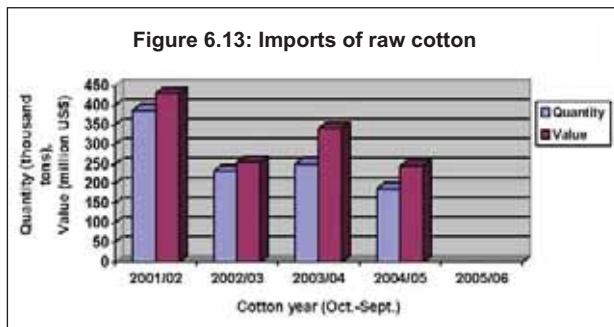

Source: Directorate General of Intelligence and Statistics (DGCI&S), Government of India.

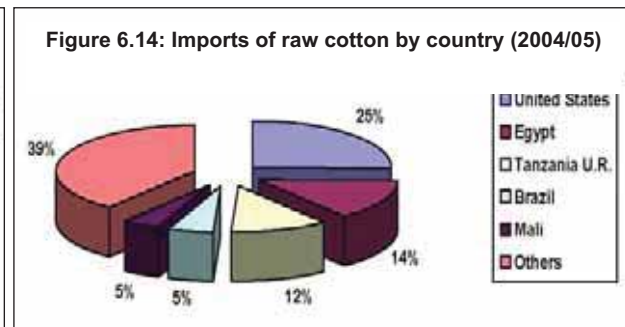

Source: Directorate General of Intelligence and Statistics (DGCI&S), Government of India.

Supply and demand in the national market

Cotton farmers sell their produce in market yards through an open auction/tender system following the prevalent market practices in the various yards. The main buyers are local ginneries, traders and commission agents, as well as government agencies such as the Cotton Corporation of India (CCI). Farmers are free to sell their produce to any of the above-named buyers, and even not to sell if they find the prices are too low. The arrival span is spread from October to April/May, with peak arrivals from December to February. June to September are the lean periods for cotton arrival.

The pace of cotton demand from the domestic textile industry is a crucial determinant in stabilizing prices. Most of the mills plan their purchase programme taking into consideration the different cotton varieties to be procured from various cotton growing areas. While progressive and rich buyers may make aggressive purchases if market conditions are favourable, the medium and small mills cover their cotton requirements for short intervals. Normally, demand from the mill sector is more concentrated in-season and is scaled down during the off-season.

Specific cotton quality requirements of the domestic textile industry

India is the largest exporter of cotton yarn in the world, with 23% of world trade. Indian mills require ELS cotton for the production of super-fine yarn counts of 60s and above. Made-ups and other textile articles also require fabrics manufactured from ELS cotton. India's production of ELS cotton is far below the local requirements of the textile mills.

Import developments over the last few years

During the period from 1999/00 to 2002/03, there were large-scale imports of cotton into India, mainly because of price considerations. International prices nose-dived in year 1999/00, when prices reached their lowest level for 30 years.

In addition to imports driven by price considerations, domestic cotton production was not encouraging, resulting in domestic prices being much higher than international prices.

With significant improvement in cotton production in the last few years, the export and import scenario has changed drastically. Even after meeting the increasing cotton requirements of the domestic textile industry, there is surplus cotton for export sales and, at the same time, no imports are taking place purely on price considerations. The imports that are taking place are for specific quality of ELS grades to cover its short supply in the domestic market.

Analysis of import tariff structure

The applied rate of duty (as at July 2006) on cotton falling under tariff line 5201: Cotton, not carded or combed is 10%. The effective rate of import duty including Special CVD and Education Cess is 14.8%. The example below illustrates how duty is calculated on imported raw cotton.

Example:	(i)	CIF price of imported cotton	\$100.00
	(ii)	Landing charges (@ 1% of CIF)	\$1.00
	(iii)	Landed cost or assessable value [(i) + (ii)]	\$101.00
	(iv)	Basic customs duty @ 10% of (iii)	\$10.10
	(v)	Special CVD @ 4% of [(iii) + (iv)]	\$4.44
	(vi)	Education Cess @ 2% of [(iv) + (v)]	\$0.29
	(vii)	Effective rate [(iv) + (v) + (vi)]	\$14.83
	(viii)	Final import price [(i) + (ii) + (viii)]	\$115.83

Presently, there is no import duty preference for cotton imported from African countries.

Non-tariff requirements in the domestic market

Cotton import procedure

Import of commodities including cotton into India is governed by the Foreign Trade (Development and Regulation) Act 1992, the rules and orders made thereunder, and the provisions of foreign trade policy. Imported cotton is subject to the same domestic laws, rules, orders, regulations, technical specifications, environmental and safety norms as those that apply to domestically produced cotton. Imports of cotton are freely allowed in the Indian market. Normal import procedures, like those prevalent around the world, are followed in India.

Special import regulations

The importer's clearing and forwarding agents have to obtain a phytosanitary certificate in the standard format as recognized by the International Plant Protection Convention. An import permit is also required to be obtained from the Indian Department of Agriculture.

Customs procedures

Under Section 30 of the Customs Act 1962 the importer is required to hand over an Import Manifest to the customs authorities within 24 hours of the arrival of the cotton consignment. After the customs authorities have examined the goods and assessed the duty payable, the importer makes the payment. The cotton is cleared by the customs appraiser only after payment of the duty.

Freight forwarding and transport requirements

Cotton containers can be delivered to any port or inland customs depot as per the customer's requirements. The containers can also be unloaded directly at the factory premises. Mostly, inland movement of cotton is done by truck. There are no additional formalities for movement of cotton from one State to another State.

Packaging, marketing, labelling and specific domestic business practices

All cotton bales are processed in the ginneries and packaged with bailing iron hooks and hessian cloth, which is now being replaced by cotton cloth to avoid contamination. Bales are pressed in a standard weight of 170 kg (1 bale) and press marks are affixed on the bales immediately after pressing.

Contract negotiation is carried out between buyer and seller through various modes of communication, including oral arrangements through telephone conversations and written communications by fax or e-mail, as well as personal visits by mill representatives to the ginneries. If the quality does not conform to the agreed parameters, discounts are determined and settled; in some cases the parties resort to arbitration.

The cotton trade in India is still a traditional business with age-old ties still reigning supreme among a majority of the suppliers and buyers. Most supplies are on credit including financing by the suppliers. By and large, commitments are honoured by both the parties. With the cotton market getting more competitive year by year, suppliers are now under constant pressure to adhere to quality parameters and delivery schedules for healthy long-term business relations with their client buyers.

Expected market developments

The Indian Cotton Mills Federation (ICMF) has projected that in the wake of the abolition of the quota regime, India will require about 5.95 million tons of cotton by 2010. The Indian textile industry will require imports of 255 thousand tons of extra long staple cotton by 2010, much higher than the present level of production of 44.2 thousand tons in 2005/06. India's production of ELS cotton is far below the local requirements. African farmers can profit from these opportunities in the years to come.

The domestic market: a micro view

Different players in the market

The different players in the market comprise traders, commission agents and ginneries, most of which also trade in cotton. Nearly 85%–90% of cotton is marketed through these players, who procure raw cotton either from the market yards or direct from the villages, and then offer that cotton to the consuming mills. Across the cotton season, these players also build inventories in different proportions, depending upon their assessment of market demand and supply as well as expected prices. Government agencies such as the Cotton Corporation of India (CCI) also play an important role in stabilizing prices through timely market interventions.

Imports of cotton by the user textile mills are indented through international sellers, working mostly through Indian agents. Importing mills rarely visit the country of origin when buying cotton; they depend on the services of agents for contract performance, including selection and shipping formalities.

Specific cotton contracts used in the market

Every market has its own terms and conditions. Local cotton associations have terms and conditions relating to weights, payment terms and quality disputes. Contract terms can vary from transaction to transaction, depending on demand and supply in the market.

Cotton Trading Associations such as the East India Cotton Association (EICA) have standard contracts in place specifying qualitative, commercial and technical terms. The parties to cotton trade have the option of following standardised contracts for cotton transactions and commercial dealings. In practice, fully pressed cotton bales are sold and bought on verbal contracts in private trade. Written contracts are prevalent in public sector organizations.

For example, under the EICA 'Rules of Arbitration', all parties wishing to make reference to EICA arbitration should include the following arbitration clause in writing in their contracts or agreements:

'Any dispute or difference whatsoever arising between the parties out of this contract shall be settled by arbitration in accordance with the Statutory By-laws and Rules of Arbitration of East India Cotton Association. The award made in pursuance thereof shall be binding on the parties.'

Any party to a dispute relating to a claim arising out of cotton transaction and/or any commercial matter relating to cotton between two or more parties in India or other than in India wishing to commence arbitration proceedings shall write to the Secretary, East India Cotton Association (EICA) for arbitration. The written request must be accompanied by the statement of the claim and facts supporting the claim, copy of the contract and appropriate fees. Arbitrator(s) to hear the dispute will be appointed by the Association after giving notice to the parties to the dispute. The place of arbitration is India. The parties can also request a fast track arbitration proceeding to decide the reference in a fixed time frame of one to two months or any other time not exceeding three months. The award announced by the arbitral tribunal is final. The tribunal makes no award unless the case of the party applying for the arbitration has been brought to the notice of the other party. Whenever there is more than one arbitrator, the award of the majority will prevail and be taken as the decision of the arbitral tribunal. The tribunal is supposed to decide the award within three months from the date of reference, subject to extension of such durations as may be decided by the Chairman, EICA. The parties have a right of appeal to the Board of the Association within 15 days in the case of parties in Mumbai, 20 days in the case of either of the parties being elsewhere in India, and 30 days in the case of either of the parties being elsewhere than in India, from the date of receipt of the award and subject to payment of appeal fees as laid down in the schedule of fees.

Cotton finance and payment regulations

Banks are the major source of finance for ginners and mills. Most of the Cotton supplied by trade to the textile mills is on credit terms for intervals ranging from 30 days to 90 days. The textile mills continue to make payments against past supplies and also enter into fresh transactions for future supplies. Many cash-rich mills buy cotton on an immediate payment basis, under which they can enjoy the benefit of competitive rates. For cotton imports, payment is made to the exporter by L/C.

Use of e-commerce and ICT for procurement

Being a traditional business, the use of e-commerce and ICT are still not popular in the cotton trade. It will take few years before Indian companies start using e-commerce for procurement.

Consumer preference for specific fibre types and blending

All types of cotton suitable for spinning 20s count to 120s count are available in India. Buyer emphasis is mainly on the quality of the cotton with respect to its prime parameters. Contamination-free cotton is definitely preferred. It is generally observed that consumer preference is for cotton garments over synthetic and synthetic blended garments, as cotton garments are more comfortable.

The consuming textile mills have a preference for specific fibre types depending upon the count pattern of yarn they sell in the domestic or international market. For example, for producing 40s yarn, the mills use cotton varieties with different staple groups – 28 mm, 29 mm and even 30 mm. For producing cotton yarn of export quality in superfine yarn counts of 60s and above, ELS cotton is used by Indian mills. Other fibre characteristics such as micronaire, strength and grade also make a difference when choosing any particular variety.

Large national cotton consumers

Case studies of large national cotton textile mills indicate that most of the big companies source approximately 75% of their requirement domestically. Large companies use imported cotton for yarns finer than 50s count. ELS cotton is imported from Egypt, the United States, and occasionally from African countries. The product portfolio of composite mills includes denim, shirtings, knits and other fabrics as well as garments. Cotton is directly sourced from ginners through brokers as well as institutions. Quality specifications for different varieties are generally fixed by most of the companies prior to the start of the buying season, and purchases are carried out keeping these specifications in perspective.

Their recommendations on how best to penetrate the domestic cotton market

The textile groups plan their cotton coverage programme taking into account the overall demand and supply position, market sentiments, expected prices, the international situation and other similar factors. International exporters wishing to sell cotton to Indian mills need to evolve a system for informing the mills of the qualities and quantities of cotton they have available for sale, the rates and terms etc., via a combination of telephone calls, faxes, e-mails, websites etc., possibly followed by personal visits to the mills. Alternatively, the same communication can be achieved with the help of overseas and domestic agents. Ultimately, the success of any international merchant in penetrating the Indian market depends on price competitiveness. Hence, efforts by exporters before the sale deal will go a long way for penetrating the India cotton market.

Possible niche markets and product groups to be targeted

Organic cotton production in India is highly disorganized, and it will take some time for the concept of organic cotton to get due publicity among farmers. The consumption of organic cotton has been on the rise in India, with the market for organic cottons increasing slowly but significantly as India is targeted as a major manufacturing hub. Various international brands are already sourcing

and manufacturing in the country, so the consumption of organic cotton is sure to increase during the coming years. Considering the ever-increasing global demand for eco-friendly textiles, there is likely to be substantial demand for organic cotton in India to meet its raw material requirements.

Existing national support schemes

Presently, cotton mills and traders can import cotton from any source. No special preference is given to African LDCs exporting cotton to India.

India is one of the signatories to the Duty-Free Quota-Free (DFQF) Scheme for LDCs by 2008 under WTO Hong Kong Ministerial Declaration. The African cotton producers can benefit from such a scheme whenever it is announced by the Government of India.

Recommendations for LDC cotton exporters on increasing exports to India

African cotton producers need to have adequate knowledge of the requirements of the Indian cotton importers. They should know important factors such as the quality and quantity of cotton yarn production, domestic prices for each quality, and the demand for cotton yarn and textile products for domestic as well as export markets. All these factors have a major bearing on cotton purchase decision-making by Indian companies. Knowledge of the product mix of major cotton consumers in the Indian market is also very useful for cotton suppliers.

Indian consumers, especially the export-oriented yarn manufacturers, garment manufacturers, weavers and spinners need consistency in fibre quality. Large Indian companies are ready to pay a premium for sourcing extra long staple cotton from LDC exporters provided the cotton supplied is free from any contamination.

LDC exporters must also have a fair idea of the varieties of cotton produced in India and the varieties imported from other major suppliers of cotton. The cotton production cycle in India starts in October, and the arrival of cotton is at its peak from December to February in the domestic market. LDC farmers could target June to September, which are the lean months for cotton arrival.

Domestic companies do not differentiate between foreign suppliers and Indian suppliers, as long as they are getting quality cotton as per their requirements at competitive prices. An overseas supplier can sell cotton to Indian mills either direct or through agents in India, but the actual orders would depend on price competitiveness. The basic skills to penetrate new markets, negotiation skills and knowledge of distribution channels in India are other major factors.

Indonesia

The Indonesian textile industry: a macro view

The Indonesian textile industry is one of the oldest and most strategic industries of the country and contributes significantly to national growth. About 1.8 million people are directly employed in the textile industry, and about 3.7 million are indirectly employed in the textile sector.

Indonesia is a major player in the textile and clothing industry in Asia. According to the Ministry of Industry, the value of textile production was estimated at IDR 125,000 billion (\$18.7 billion) in 2005. The value of textile and textile products exports reached \$8.6 billion in 2005, making Indonesia the eleventh-largest textile exporter in the world. Indonesia, an oil-producing country, houses one of the world's largest synthetic fibre manufacturers.

The domestic production of cotton is of limited commercial importance and is declining. Thus, the Indonesian textile industry depends almost entirely on imported cotton for all its requirements for the domestic and the export markets.

Supply and demand in the national market

Domestic cotton production

Despite its sprawling land area, Indonesia is not a very favourable place to grow cotton on a commercial scale. Although the land is naturally fertile, the climatic conditions are not very suitable for cotton plantation.

Cotton production in Indonesia is stagnating at a very low level incommensurate with the needs of the local spinning industry. This is mainly due to climatic and soil limitations, and to farmer preference for growing alternative crops with higher yields and profits and shorter growing periods.

Average cotton yields remain low and are unlikely to increase without new technology. No significant effort has been made to increase yields or to reintroduce the use of biotech cotton since commercial production was discontinued in 2002 when it proved to be not commercially viable.

The country's cotton production accounts for less than 2% of demand. The harvested area is estimated at about 10,000 hectares and the production around 6,000–7,000 tons of lint. South Sulawesi, Central and East Java and West Nusa Tenggara are the major cotton producing areas in Indonesia.

The Indonesian spinning sector

The total spinning capacity of Indonesia is about 7.8 million spindles, out of which about 45% are used to produce cotton and cotton blend yarns. Indonesian mills are producing predominantly lower counts ranging from 10s to 45s, and a very small quantity of finer counts (60s to 80s). About 60% of yarns produced are directly exported all over the world and the balance is converted into fabrics and garments for the domestic and the export markets.

Indonesian mills are running at around 70% capacity. About one-third of total spinning machinery and two-thirds of total weaving capacity are reportedly more than 20 years old. However, firms that have made recent investments and modernized their plants are operating near full capacity.

Older machinery tends to use power inefficiently and operate at lower productivity levels than newer machines in competing countries. Textile labour in Indonesia has higher wages and lower productivity than other Asian textile exporting countries and the cost of electricity is relatively high.

Bank loans are rather difficult to come by, particularly for the textile and clothing sector, because of the current world market situation and because of the competitiveness of Indonesian mills compared to other countries' mills.

The domestic market for local textile and apparel production is shrinking because of fierce competition from lower-priced imported products. Smuggling of imported textile products and second hand garments is a serious problem for the Indonesian textile manufacturers.

Mill consumption of cotton rose very rapidly from 100,000 tons in 1980 but has levelled off at around 480,000 tons since the mid 1990s.

Indonesia is a net exporter of cotton yarn and cotton fabric. In 2005, Indonesia exported 98,000 tons of cotton yarn (mostly to Hong Kong (China), Japan and the Republic of Korea) and imported 24,000 tons, out of which 10,000 tons came from Pakistan. Indonesia exported 490,000 tons of cotton fabric and imported 123,000 tons in 2005.

Future demand

In March 2007, in order to increase the cost efficiency and competitiveness of the textile industry, the Government of Indonesia issued a regulation to provide assistance to textile manufacturers who modernize their equipment. Companies will be reimbursed 11% of the cost of the textile machinery up to IDR 5 billion (\$925,000).

Nevertheless, given the constraints described above, mill cotton consumption is expected to remain stable at approximately 480,000 tons.

Imports of cotton into Indonesia

Indonesia is the third-largest importer of cotton behind China and Turkey. Official statistics available show that cotton imports into Indonesia remained stable around 450,000 tons from 2004 through 2006, down from 523,000 tons in 2003 and 625,000 tons in 2002. In 2006 Indonesia imported cotton valued at \$620 million.

Indonesia sources raw cotton from all over the world. Statistics reveal that the top 20 suppliers account for about 90% of Indonesian imports. Australia was traditionally the dominant cotton supplier until 2002 with a market share close to 40%. However, the drought that reduced Australia's exportable supply of cotton has resulted in an increase of imports from the United States. In 2006, the United States accounted for 34% of Indonesian imports, and Australia for 20%. Imports from India reached 9% of the market in 2006, surpassing those from Brazil (8%). Twelve African countries were among the top 20 suppliers in 2006, together with Uzbekistan, the Syrian Arab Republic, Pakistan and Mexico.

Table 6.4 Indonesian cotton imports, by country of origin, 2002–2006 (in kg of lint)

Country	2002	2003	2004	2005	2006
United States	197,803,383	182,859,091	142,642,590	180,605,223	159,300,815
Australia	240,138,695	168,037,576	89,736,123	84,495,389	92,326,159
India	355,683	767,749	12,455,996	8,030,489	42,595,872
Brazil	10,613,723	8,957,019	40,021,738	40,377,947	36,625,894
South Africa	12,130,173	8,789,890	24,095,072	10,402,034	15,522,121
Burkina Faso	4,025,729	3,530,743	7,017,805	7,290,757	9,720,313
Côte d'Ivoire	22,640,317	13,056,324	10,187,084	8,056,086	7,633,668
Uzbekistan	2,099,741	2,622,452	2,061,121	8,907,716	7,236,541
Mali	3,991,499	3,996,496	5,886,983	6,217,750	7,438,422
United Republic of Tanzania	5,158,207	9,372,254	8,031,969	6,823,585	7,314,319
Mozambique	1,502,013	2,085,436	1,796,326	1,911,888	6,324,504
Central African Republic	3,472,795	7,263,367	5,485,189	5,328,035	5,889,703
Pakistan	10,955,003	8,552,156	12,718,268	11,845,627	6,191,678
Zimbabwe	392,269	583,460	7,592,003	4,032,765	5,170,686
Syrian Arab Republic	15,458,237	6,439,335	4,943,992	10,195,240	5,279,658
Mexico	3,417,167	3,422,535	2,580,044	1,630,404	4,850,100
Cameroon	2,068,123	1,988,609	6,014,433	3,073,837	4,740,282
Uganda	1,007,884	2,762,572	2,894,905	7,052,953	3,779,152
Malawi				924,410	3,546,030
Togo	4,564,033	4,952,987	7,956,083	8,073,825	3,159,974
Sub-total	541,794,674	440,040,051	394,117,724	415,275,960	434,645,891
<i>Other countries</i>	<i>83,357,740</i>	<i>83,083,696</i>	<i>54,572,344</i>	<i>40,108,497</i>	<i>28,559,353</i>
Total imports (kg)	625,152,414	523,123,747	448,690,068	455,384,457	463,205,244
Total value (US\$)	704,791,994	644,482,877	679,914,018	576,003,602	619,894,876

Source: Ministry of Industry and Trade, Indonesia.

Specific cotton quality requirements of the domestic textile industry

Indonesia consumes and imports a wide range of raw cottons from short staple to extra long staple. The bulk of imports have a staple length ranging from 1" to 1-1/8".

Cotton is sold on the basis of USDA classing on approved ratings of fibre properties such as the fibre length, strength, uniformity, elongation, brightness and maturity (micronaire), and in different grades such as good middling and strict middling.

Cotton import procedures in Indonesia

Import of raw cotton is freely allowed for all users such as mills and converters into yarn for re-export. There are neither inhibitive procedures nor any strangling non-tariff barriers in force restricting the growth of this sector.

There is no import tariff imposed on raw cotton except VAT, which is adjusted against the company's other categories of tax obligation. Since there are no import tariffs in force, the usual routes for helping to improve trade volumes through preferential or differential duty treatment may not be applicable. In

January 2007, the Indonesian Government issued a regulation that eliminated the 10% VAT imposed on certain primary agricultural products, including cotton.

Unlike some other Asian countries, the local Indonesian spinning mills do not get any export incentives from the Government.

Major international cotton shippers

Textile companies import cotton mostly through international trading houses. These traders have local representatives or agents. Indonesian buyers prefer to establish long-term relationships with a few agents who represent reputable trading companies in various cotton exporting countries.

Because of the dependence on imported cotton fibre, all the major world players in the cotton trade are represented in Indonesia and it has become a highly competitive market. Leading companies such as Dunavant, Cargill, Allenberg, Reinhart, Volkart, CDI, Copaco are active, as are a few of the leading Japanese trading houses such as Marubeni, Nichimen and Toyo.

Strangely enough, some shippers are represented by two or three agents, triggering an unhealthy situation of price wars between agents who are representing the same shipper.

Selling practices

Prices are ruled by the international market. Agents send daily quotations to the mills; the mills compare various such quotations from different agents and place a bid with an agent depending on the competitiveness of the quote, their prior working relationship with the agent, payment terms, etc. Generally terms are based on L/C at sight, or on a certain amount as advance payment and the rest by telegraphic transfer. However, there are many different ways of arranging payment, depending on how well the buyer and seller know and trust each other. The bid thus received from the buyer is sent to the shipper and with due negotiations a deal is struck to be executed in accordance with their agreed terms.

Besides forward sales at fixed price, cotton may also be sold on the basis of New York Futures options for forward shipment.

Indonesian importers generally follow International Cotton Association (ICA) rules and contracts.

Recommendations for LDC cotton exporters on increasing exports to Indonesia

Quality and its consistency are the prime factor in increasing market share of cotton in Indonesia. If the share of cotton from Africa is to be increased from the present level of 18% of total consumption in Indonesia, the first step is to ensure good quality parameters similar to their counterparts from Australia and America, which are widely used in Asian countries. Further, consistency of quality should be ensured over all bales and all shipments.

In general, quality parameters of cotton from different regions of Africa lie within a narrow range compared to cotton from other countries, where a wide range of cottons from short staple to extra long staple are available. African cottons are mostly confined to 30–40s ring spun mixings (not suitable for open

end yarns), coarse count and super fine count ring yarns for 30–40s mixes with Australian Andy and American Fibermax cotton, which are widely used in Indonesia.

African cottons suffer from external contamination in cotton bales that result in huge claims and complaints. Cotton from African regions is regarded as far inferior to the cottons from developed countries such as Australia and the United States in this regard. Other developing countries such as China and Brazil are regarded as better than Africa in this respect. Unfortunately, this heavy contamination of African cottons, which are otherwise comparable to Australian and American growths in basic quality characteristics, makes them less competitive in the Indonesian market.

Improvement in fibre characteristics in terms of trash, honeydew, stickiness and contamination would help African cottons to remain competitive with cotton from other countries.

Indonesian spinners suggest five other areas where improvements are needed to increase the market share of African cottons:

- ❑ **Instrument testing of cotton.** African cottons are sold on types – generally national types – rather than on actual description. Present day end-users in the international market need actual description and instrument results, as available from developed countries such as the United States and Australia. Instrument test results are accurate and reliable, and eliminate subjectivity in grading and classing. If all bales are tested, and data is provided to everyone in the chain, instrument testing gives confidence to the end-users that the cotton bales are tested and classified properly. Instrument results enable spinners to efficiently use cotton for their specific end-uses at minimum price. Efficient use of cotton by spinners, in turn, would increase the demand for cotton. Further, instrument test results would help the seed breeders and growers to keep track of the quality record of different growths.
- ❑ **On-time shipments.** It is important that all consignments reach end users on time. African cotton exports suffer from the lack of inland transportation facilities from gins to port, the lack of facilities at port and political instability.
- ❑ **Country damage.** Quite often bales from African countries are found with country damage due to poor storing and handling. Water damage, soiling with red sand and dust, presence of oil, and black soiled bale surfaces and torn bale covers are some common features found in African cotton bales by Indonesian spinners.
- ❑ **Price competitiveness.** It is important to keep prices competitive with those of cottons from other developing countries such as Brazil and India.
- ❑ **Spot buying facilities in Indonesia.** To enhance consumption of African cotton in Indonesia, facilities for stocking various growths of African cotton could be provided to enable end-users in Indonesia to spot-buy.

If the above quality and marketing issues are addressed, then there is ample scope to increase African cotton exports to Indonesia.

Pakistan

The structure and characteristics of the domestic cotton market

The importance of cotton in Pakistan's economy

Cotton and cotton products represent 61% of Pakistan's export earnings. Textiles are linked to the country's economic growth. The cotton consumption growth rate during the last five years was 5.7%, while the economic growth rate was 7%.

Pakistan has the third-largest spinning capacity in Asia, with over 10 million spindles and 200,000 rotors. Based on historic expansion in the textile industry, the All Pakistan Textile Mills Association (APTMA) projects that capacity will increase to 15 million spindles and textile exports to US\$ 15.5 billion by 2010. According to APTMA, fibre consumption at present is 2.4 million tons, comprising 1.9 million tons of cotton fibre and 0.5 million tons of man-made fibre (MMF), the mix ratio being 79:21 compared with a global ratio of 40:60.

Local cotton production by 2015 is projected at 3.5 million tons. APTMA estimates that the textile industry's raw cotton requirements by 2015 will be 3.4 million tons, consisting of medium staple (66%), long staple (26%) and extra long staple (8%). Long and extra long staple requirements are met through imported cotton; hence Pakistan is a potential market for exporters in this category. Details of APTMA's Textile Vision 2010 are shown in table 6.5.

	Size	Production	Exports (US\$ 000)	Size	Production	Exports (US\$ 000)
MMF		635,000 tons			1,000,000 tons	–
Spinning	10 million spindles	1,900,000 tons of yarn	1,176,449	15 million spindles	2,900,000 tons of yarn	600,000
Weaving	27,000 shuttleless looms	5,600 million square metres	1,765,486	50,000 shuttleless looms 300,000 standard looms	8,500 million square metres	800,000
	225,000 standard looms					
Bedwear			1,388,350			3,000,000
Knitwear	21,000 knitting machines	350 million pieces	1,471,426	38,000 knitting machines	650 million pieces	2,600,000
Readymade garments	450,000 machines	650 million pieces	1,003,499	670,000 machines	940 million pieces	2,500,000
Finishing		4,800 million square metres			7,500 million square metres	2,500,000
Other made-ups						3,500,000
Total textile exports						15,500,000

Source: All Pakistan Textile Mills Association.

The reduction in exports from the spinning and weaving sectors is countered by a sizable increase in value-added sectors such as bedwear, knitwear, readymade garments and finishing. The Government is helping the industry to diversify towards value-added exports.

National production

Cotton is cultivated in two provinces: Punjab, which produces 79%, and Sindh, which produces 20%. Negligible quantities grow in the remaining two provinces, North-West Frontier Province (NWFP) and Balochistan.

Cotton production since 2000 is shown in figure 6.15.

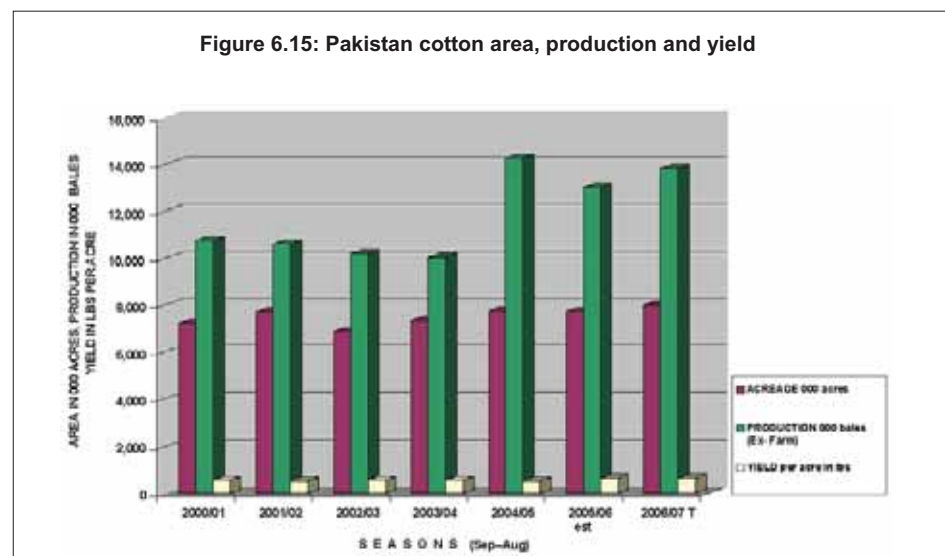

Source: Ministry of Food, Agriculture and Livestock, Government of Pakistan.

Note: T = target.

Pakistan ranked fourth in world cotton production and third in world cotton consumption in 2005/06 with shares of 8.5% and 9.6% respectively. Cotton yarn production and exports enjoy second and first positions with 8.9% and 23.8% shares, while cotton cloth production and exports are in second and fourth positions with global shares of 14.7% and 11.0% respectively.

Market size and prices

There is a positive correlation between domestic prices and international prices (coefficient 0.9), and the benefit of international market prices is passed on to the grower. Prior to 1999/2000, prices of both seed cotton and lint were determined on the basis of variety. However, from 2000 onward, local prices have been determined on the basis of grade, as approved by the Pakistan Cotton Standards Institute.

To support growers, the Government announces minimum assured prices for seed cotton every year. Though seed cotton market prices have remained above the support levels, they have shown erratic behaviour. From a peak in 2003/04, there was a decline in prices in 2004/05 due to record cotton production at home and globally. Large imports also dragged local prices down. Seed cotton and lint prices are shown in figures 6.16 and 6.17.

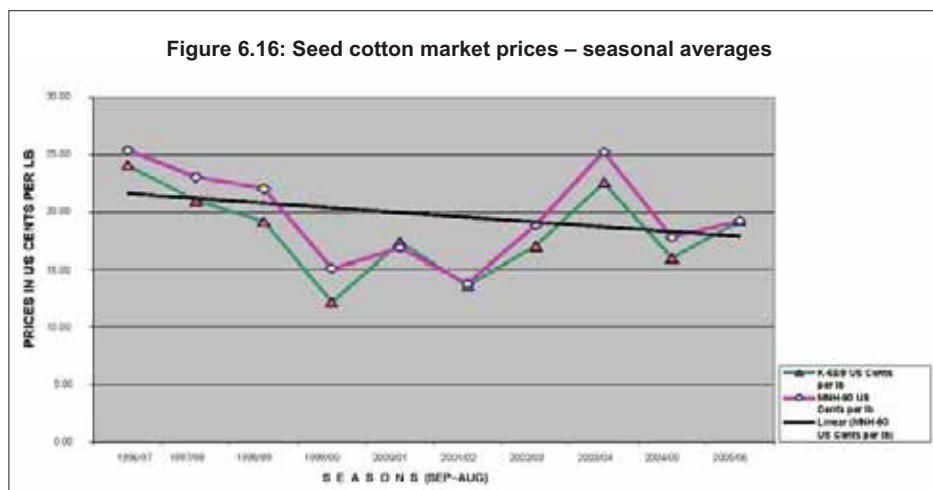

Source: Ministry of Food, Agriculture and Livestock.
 Prices from 2000/01 onward are for Base Grade-3 with staple length 1-1/32".

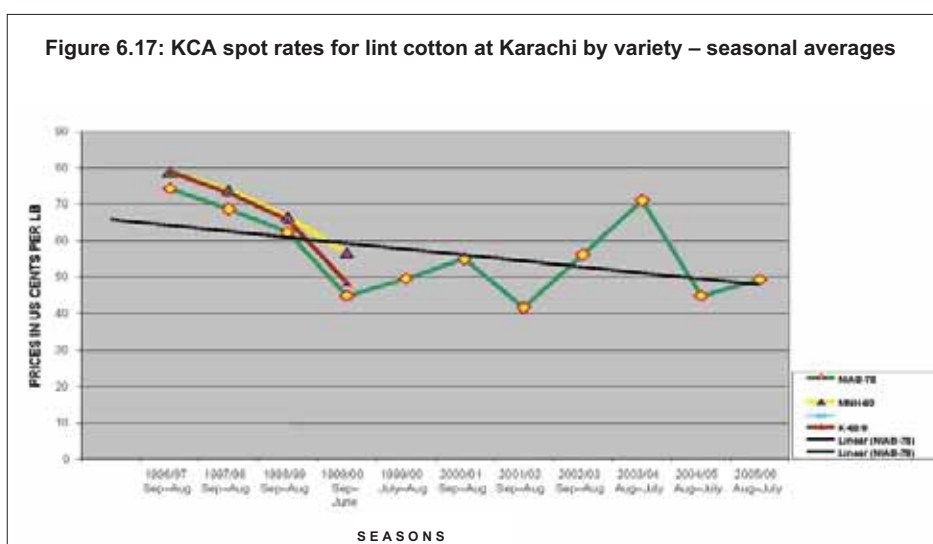

Source: Karachi Cotton Association.
 Prices from 2000/01 onward are for Base Grade-3 with staple length 1-1/32", Micronaire 3.8–4.9 NCL.

Cotton qualities supplied by the domestic industry and from abroad

Local production is mainly composed of medium and medium long staple with a maximum staple length of 29.8 mm, and meets 85% of the mill requirements. In 2004, CIM-707 was developed with a staple length of 32.2 mm, micronaire 4.2 and strength (tpsi) of 97.5, but its production is small. Long and extra long staple cotton is imported to spin higher counts for export markets. Medium staple cotton is imported when supply is short in the local market.

Major commercial varieties grown and marketed are CIM-446, CIM-496, FH-1000, BH-160, NIAB-999, NIAB-111 and ALSEEMI-151. Cotton breeders are motivated to give due emphasis to optimal micronaire and strength besides increasing staple length to enable the textile mills to spin higher count yarn from local cotton.

Supply and demand in the national market

The supply and distribution of cotton have increased during the last five years because of higher production, consumption and imports. Production and consumption are both estimated at 2.2 million tons during 2005/06 and

imports at 390,000 tons. While production and consumption increased by 22.5% and 23.5% respectively in the last five years, imports increased substantially by 109% during the same period. Major imports in 2005/06 were from the United States, Brazil, India, Egypt and Australia, as shown in figure 6.18. Cotton arrives in Pakistan from 95 origin countries. During 2002–2005, Pakistan was the top buyer of United States Pima cotton. In 2005/06, Pakistan was the biggest buyer for Egyptian long and extra long staple varieties. Pakistan spinners also imported African cottons, mainly from Angola, Botswana, Ghana, Morocco, Niger, Mali, Mozambique, Benin, Côte d'Ivoire, Burkina Faso and Togo.

The qualities ranged from strict low middling to middling. There has been a substantial decline in imports from West Africa according to shipment data compiled by the Federal Bureau of Statistics.

Imports (mainly long staple cotton) have also grown over the last five years, as shown in figure 6.19. An overview of cotton supply and consumption is given in table 6.6 (see page 287).

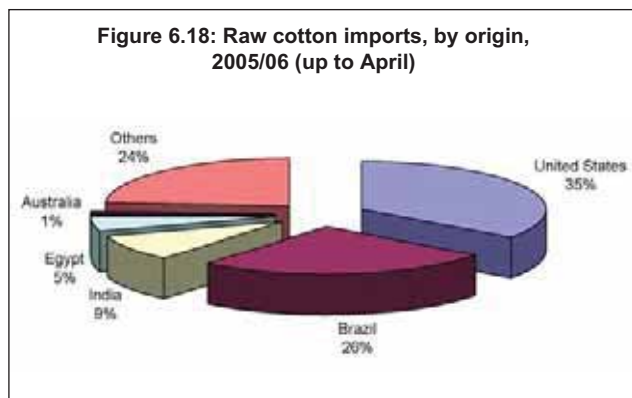

Source: Federal Bureau of Statistics.

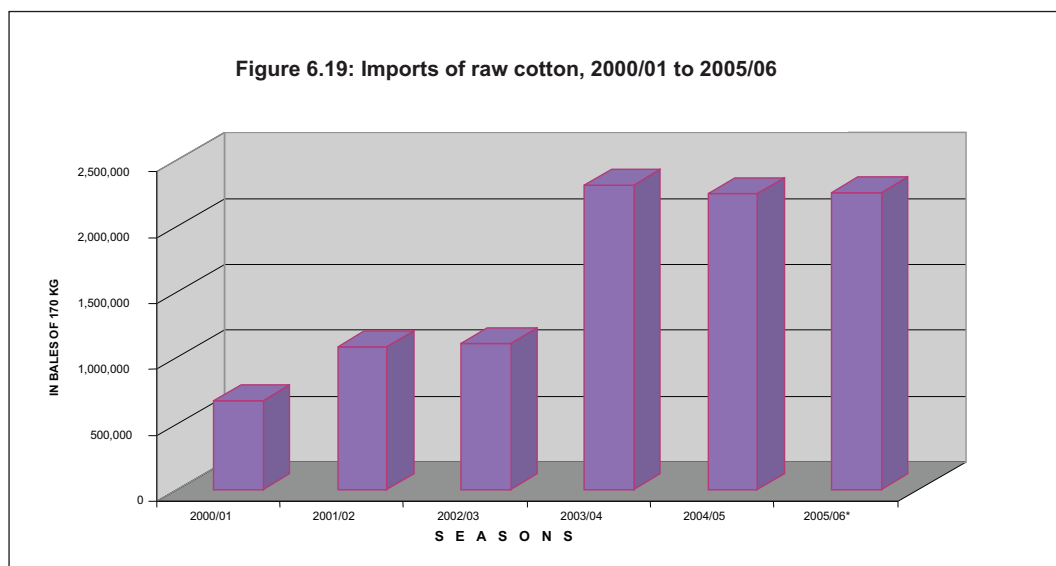

Source: Federal Bureau of Statistics.

* Estimates

An analysis of the tariff structure of imports

Tariff structure

Raw cotton not carded or combed is exempt from customs duty and sales tax under the Import Policy Order 2006. Charges paid by the spinner from the port to the warehouse are 3.32% of the C&F import price as illustrated below:

	United States cents per kg
(i) Let C&F price of imported cotton be	100.00
(ii) Insurance charges paid to the shipping company @ 0.20 % of the invoice value	0.20
(iii) Fumigation charges @ Rs. 20 per bale of 220 kg	0.15
(iv) ETO (Excise and Taxation Office) charges @ 0.5 % of invoice value	0.50
(v) Terminal handling charges @ Rs. 8,500 per container of 80 bales or 17,600 kg	0.79
(vi) Wharfage charges by Karachi Port Trust @ Rs. 5,500 per container of 80 bales or 17,600 kg	0.51
(vii) Clearing and forwarding agent's commission @ 0.5 % of invoice value	0.50
(viii) Letter of credit opening charges by bank @ 0.35 % of invoice value	0.35
(ix) Insurance charges from port to spinner's warehouse @ Rs. 750 per container of 80 bales or 17,600 kg	0.07
(x) Miscellaneous expenses	0.25
(xi) Total charges from (ii) to (x)	3.32
(xii) Final import price (i) + (xi)	103.32

The entire international trade of Pakistan is conducted on multilateral basis. There is zero rating customs duty and therefore no preferential treatment.

Non-tariff requirements in the domestic market

Customs procedures

Cotton consignments arrive in containers at two ports, Karachi Port and Port Qasim. Customs formalities are handled by the freight forwarders appointed by the buyers.

Once the shipment has been made, the shipper sends the original, negotiable documents to the importer's bank and a non-negotiable set to the importer. The importer gives a copy of this set to the freight forwarder for customs clearance in advance. The freight forwarder obtains the import permit issued by the Department of Plant Protection, Ministry of Food, Agriculture and Livestock. If the import permit is acquired after arrival of the consignment, a penalty of 5,000 rupees is levied on the importer. The bank notifies the buyer to collect the original documents; on the buyer's instructions, the bank gives the original documents to the freight forwarder, who presents them to the shipping line for clearance.

After clearance, the shipping line issues the delivery order. Before the arrival of the vessel at the port, terminal handling charges are also paid. An anchorage permit is obtained from the Quarantine Division of the Ministry of Food, Agriculture and Livestock. A phytosanitary certificate is also obtained from the Plant Quarantine Service to certify that the raw cotton in the consignment is free from all pests and diseases, particularly *anthonomus grandis*, and that the consignment has been fumigated with 3–4 lb of methyl bromide per 1,000 cubic feet for 48 hours before loading.

After completion of customs formalities, a release order is issued by the Department of Plant Protection. If the phytosanitary certificate has not been acquired, a penalty of 10,000 rupees is due and if fumigation was not done at

the port of loading, a 5,000-rupee penalty is levied on the importer. While there are no duties on import of cotton, the importer does have to pay 1% income tax on the total invoice value.

Specific domestic business practice

Buying is done on the basis of cost plus freight, as imports are financed by local banks on the total invoice value. Agents receive quotations from their principals on the desired quality and quantity (by fax, verbal or written communication) and forward them to the spinners. Prices are negotiated between the buyer and the agent. All import buying is based on shippers' type and description. Purchases are also made on the basis of United States 'Government class' (also known as 'Green Card').

Most buying is done 'on call', e.g. unfixed prices for strict low middling 1-1/16" based on New York futures. As the cotton arrives at the buyers' warehouses, it is pledged with the bank and released on payment to the bank by the buyer or importer.

Expected market developments

The substantial shortage of long and extra long staple cottons is expected to continue in the local market. Hence, mills will largely depend on imports. Pakistan will therefore be a potential market for long and extra long staple categories in particular, with ample opportunities for African countries to penetrate and capture a sizeable market share with a long term agreement.

The domestic market: a micro view

The players in the market

The Pakistan cotton market consists of:

- Growers;
- Brokerage houses;
- Ginners;
- Karachi Cotton Association (K.C.A.), trading house;
- Trading Corporation of Pakistan (public sector organization), exporter of surplus raw cotton;
- Agents;
- Spinning mills and composite units.

Selling of seed cotton and lint is done through agents and brokerage houses. Customer ginning is done for progressive growers to maintain fibre quality and purity of seed for growing purposes. The Karachi Cotton Association is the only trading house registered with the Government. Its members have to deal with each other through licensed brokers.

Free trading in cotton export and import has been allowed by the Government since 1994/95. Sometimes, Government intervention is necessary to protect the interests of growers. This is done through the Trading Corporation of Pakistan, which performs a price stabilization role by purchasing lint cotton at a price level on parity with seed cotton (guaranteed by the Government) when the seed cotton price falls below the support level. Such cotton is sold in the local market or is exported through tenders. The corporation is also entrusted with a developmental role.

Cotton procurement practices

Importing of cotton is mostly through international merchants who have their representative agents in Pakistan. These agents are responsible for contract performance, which includes price negotiations and finalization of deals.

Specific cotton contracts used in the market

No specific contracts are used for commercial transactions. Local buying and selling is done on verbal contracts. However, written contracts are prevalent in the Trading Corporation of Pakistan, a public sector organization. For export purposes, until 1992/93 Liverpool Cotton Association (LCA, now ICA) rules were applicable for arbitration in case of any dispute between the buyer and the exporter. In 1992/93 there was a production shortfall in Pakistan and the Government suspended shipments. But ICA gave awards in favour of buyers. The Trading Corporation of Pakistan, not getting a satisfactory response from ICA, appealed in the local court and the matter is now *sub judice*.

Cotton finance and payment requirements

Cotton purchases are financed by the commercial banks according to the buyers' credit limits. Payments are made to the ginner through bank drafts. In some cases, a local letter of credit is opened.

Consumer preferences for specific fibre types and blending

Specific fibre requirements differ from mill to mill depending on production patterns, local and international demands, and textile machinery. Locally produced cotton has a staple length up to 30mm, which is used for producing up to 40s counts. For higher counts, long and extra-long staple (ELS) cotton is imported. Other fibre characteristics such as colour, micronaire, strength and grade are important factors in cotton selection. Contamination-free cotton is of highest priority.

Preferences of large national cotton consumers

Spinners and textile producers interviewed reported that 50% of the 1.9 billion metric tons of cotton yarn used in Pakistan is coarse count (up to 20s) while 22% is medium count (21s to 34s); domestic cotton is abundantly available for these. Fine and super fine counts are made from imported cotton. Yarn merchants said that 25% of the yarn produced is exported while 75% is used by local textile and garment manufacturers. The product line of composite units includes yarn, fabrics, garments, made-ups, towels, tents and canvas, knits and bedware.

The majority of textile manufacturers said that they procure cotton from the domestic market. Five leading textile groups categorically stated that to meet the high-value export requirements for finer counts they import long and ELS cotton. Imports mainly consist of United States Pima, Egyptian Giza, Australian Andy, Chinese, Central Asian Uzbekistan and Indian Shankar cotton. They also import from Brazil and African countries for producing coarse count yarn for the towel industry, knitwear and bed sheets due to deficiency in domestic availability or price advantage.

Major spinners explained that the main reason for importing is price considerations and quality, and to fulfil yarn export commitments. Other considerations are to acquire contamination-free cotton, as well as foreign yarn buyers' country of origin preferences for specific cotton often from origins such as Australia, Egypt or Central Asia.

Local spinners' recommendations on how best to penetrate the domestic market

Almost all the spinners interviewed suggested that their most important consideration in importing cotton from any source is the reliability of the foreign shipper. International cotton merchants, through their agents in Pakistan, also interact with the textile mills. It is important that regular and authentic information about African cotton be provided to Pakistan spinners. Success in penetrating the Pakistan market largely depends on fulfilment of assured supplies of desired qualities at competitive prices.

Organic cotton

Production of organic cotton in Pakistan is in its infancy. However, prospects of cultivation are promising in parts of Balochistan province. Certification by an internationally recognized organization does not exist and is being pursued. The private sector has initiated production of organic cotton in Balochistan.

Very few mills in Pakistan use imported organic cotton from Turkey and India. The organic yarn exported has received a positive response but there is no local market at present for organic cotton.

Recommendations for LDC cotton exporters on increasing exports to Pakistan

It is important for African cotton exporters to undertake market orientation tours to the spinning and textile industry in Pakistan to acquire first-hand information on the size of the industry, specific fibre quality requirements, product lines, yarn exports, the domestic price structure, and marketing channels. Market information is the key factor in penetrating the Pakistan market.

General observations are that the recovery rate of yarn in processing African cotton is low due to presence of foreign matter and contamination. This affects the economic viability of Pakistani spinners and hence influences their buying decisions. African ginners need to improve their ginning.

LDCs should ensure contamination-free cotton, uniformity in fibre qualities and regularity in supplies for obtaining the confidence of Pakistani customers. Contamination-free cotton is used by export-oriented yarn manufacturers and weavers in Pakistan, who pay a premium price for such cotton.

Direct contacts need to be established between the African exporter and the consumer in Pakistan. The All Pakistan Textile Mills Association has suggested that a proposal be initiated at the Government level to determine specific fibre requirements by Pakistan spinners in collaboration with the All Pakistan Textile Mills Association and African cotton producers on a joint venture basis.

Pakistan mills could be invited by LDCs for a survey of ginning factories to initiate proposals between LDCs and Pakistan for joint ventures. Customer ginning and long-term agreements could also be initiated if Pakistan mills are assured regular supplies. An official certificate for African cotton quality specifications would promote trade between Africa and Pakistan with mutual price benefit to both countries.

Pakistan is emerging as a regional hub for trade and manufacturing. LDCs could benefit by arranging warehousing facilities at low cost especially in export processing zones (free zones) in Pakistan so that mills can have direct access to available ready stocks. This would facilitate spot and regular sales in the Pakistan market as well as other markets of the region and minimize logistic costs and other issues.

Spinning mills in Pakistan base purchasing decisions on availability of the required qualities and price competitiveness. Improvement in market information, developing strong relationships with buyers and improving contractual conditions are major factors that will promote African cotton sales to Pakistan.

	2001–2002	2002–2003	2003–2004	2004–2005	2005–2006 (Provisional)
Carry-over	329	340	299	339	698
Production	1,804	1,736	1,708	2,482	2,210
Imports	184	187	393	383	383
Total	2,317	2,263	2,400	3,204	3,291
Mill consumption	1,790	1,914	1,939	2,123	2,210
Non-mill consumption	85	85	85	85	85
Unspecified consumption	56	NA	NA	178	NA
Exports	46	50	37	120	64
End season stocks	340	299	339	698	932
Total	2,317	2,263	2,400	3,204	3,291

Sources: Textile Commissioner's Organization, Ministry of Textile Industry, Ministry of Food, Agriculture and Livestock, Federal Bureau of Statistics, Government of Pakistan.

Thailand

The structure and characteristic of the Thai cotton market: a macro view

Importance of cotton in Thailand

Cotton is an essential basic raw material for the Thai textile industry. Presently, the Thai textile industry requires more than 500,000 tons of cotton fibre as a basic raw material each year, while domestic production of cotton is around 10,000 tons. In 2005, domestic production represented only 2% of domestic demand. Consequently, Thailand imports cotton worth at least 24,000 million baht, roughly \$648 million, from the rest of the world. Thailand exported final cotton-made commodities for 200,000 million baht or approximately \$5,400 million in 2005.

Domestic cotton production

In 2005, the cotton plantation area in Thailand was 8,087 hectares, producing 10,200 tons of cotton. The cotton plantation area has gradually declined since 1981 when it peaked at 160,000 hectares. The cotton plantation and productivity can be divided regionally as follows: north, 4,189 hectares with a yield of 5,400 tons; north-east, 443 hectares with a yield of 438 tons; central 3,454 hectares with a yield of 4,449 tons. Figure 6.20 provides more information of production and consumption of cotton in Thailand.

Figure 6.20: Production and consumption of cotton in Thailand

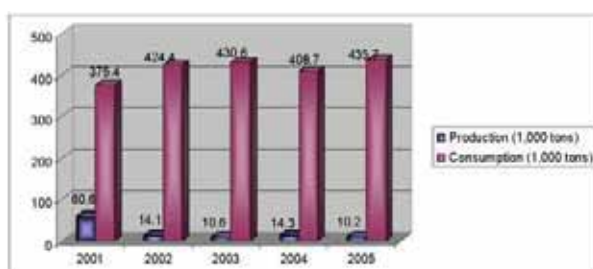

Source: Office of Agricultural Economics, Ministry of Agriculture and Cooperatives.

Government encouragement

Nowadays, the Ministry of Agriculture and Cooperatives provides less support for cotton cultivation than it needs to provide. However, the Department of Agriculture still promotes the development of cotton through research.

Figure 6.21: Planted area and production of cotton

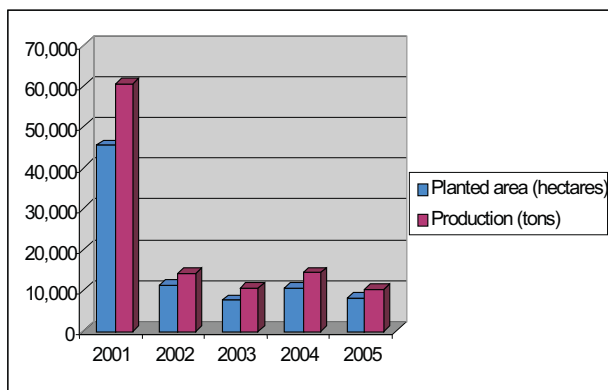

Source: Office of Agricultural Economics, Ministry of Agriculture and Cooperatives.

Figure 6.22: Annual average price of cotton

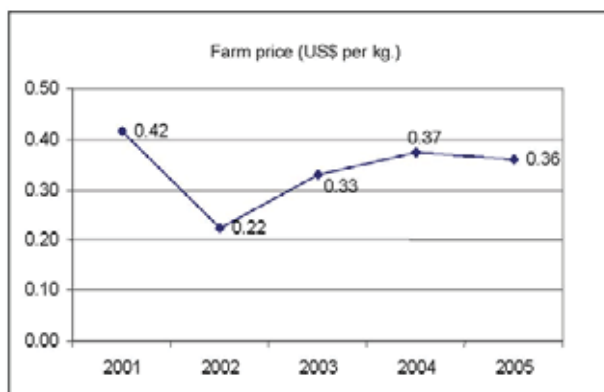

Source: Office of Agricultural Economics, Ministry of Agriculture and Cooperatives.

The Thai Government master plan indicates that growing cotton serves as a means to reduce imports of cotton. In 2002–2006 the Department of Agriculture developed a new species of long staple cotton. In 2006, a new species of short staple cotton was also developed. The total budget for improvement of cotton was approximately \$100,000–\$150,000. The developments of the planted area and production of cotton are shown in figure 6.21.

Domestic pricing structure

During the last couple of years, the price of cotton ranged from 35 US cents to 38 US cents per kilogram. In the past 10 years, the average price of cotton was approximately 37 cents per kilogram (direct purchase from farm) as shown in figure 6.22. The domestic price has mainly depended on the world market price.

Import structure

In 2006, Thailand imported 428,070 tons of cotton, amounting to approximately US\$ 574.2 million. As table 6.7 shows, since 2002, there has been no clear trend in imports of cotton.

Table 6.7 Quantity and value of imported cotton in Thailand, 2002–2006

2002		2003		2004		2005		2006	
Quantity	Value	Quantity	Value	Quantity	Value	Quantity	Value	Quantity	Value
443,873	469.3	419,346	532.0	370,703	561.8	514,982	620.8	428,070	574.2

Quantity: Tons
Value: US\$ million

Source: Office of Agricultural Economics in cooperation with the Customs Department.

In 2006, Thailand imported 114,460 tons of cotton (HS 5201) from the United States, amounting to \$161.5 million. From Australia came 94,176 tons, worth approximately \$134.8 million. Imports from the United States and Australia were 27% and 22% of total imports respectively. Thailand also imported cotton from India, Mali and Zimbabwe, accounting for 8%, 6% and 5% of total imports respectively.

Table 6.8 Quantity and value of imported cotton in Thailand, by category from top five countries, 2004–2006

Year	2004		2005		2006	
	Quantity	Value	Quantity	Value	Quantity	Value
United States	116,766,891	179,144,980	175,145,716	214,541,177	114,459,295	161,534,854
Australia	59,691,610	98,876,216	81,744,552	102,812,878	94,176,119	134,846,297
India	13,317,434	19,144,340	16,183,819	17,772,303	33,969,746	37,616,795
Mali	17,043,273	24,812,164	22,917,616	26,525,882	23,604,879	29,572,651
Zimbabwe	25,938,979	40,962,509	32,678,481	41,678,745	20,904,330	27,824,998

Quantity: Kg
Value: US\$

Source: Office of Agricultural Economics in cooperation with the Customs Department.

While in 2006 the two main providers were the United States and Australia, it is important to note that India had increased its exports of raw cotton to Thailand by more than 100% since 2005. Before 1998, India did not supply cotton to Thailand at all. In 2005 Thai imports of cotton from India were worth \$17.7 million; rising to \$37.6 million in 2006 (see table 6.8 and figures 6.23 and 6.24).

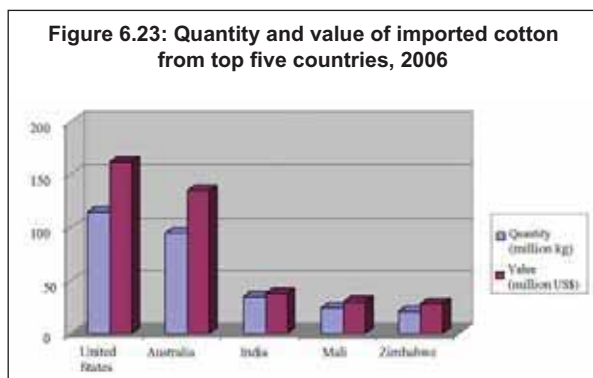
Figure 6.23: Quantity and value of imported cotton from top five countries, 2006

Source: Thailand Custom's Department.

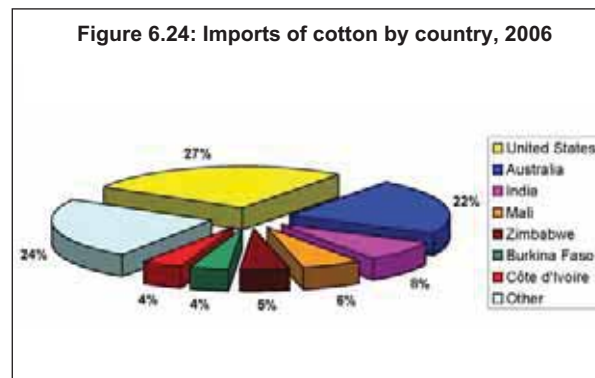
Figure 6.24: Imports of cotton by country, 2006

Source: Thailand Customs Department.

Export structure

Cotton waste is a major item of cotton export, accounting for 65% of total cotton exports. In 2006, Thailand exported 8,048 tons of cotton, amounting to roughly \$5.3 million, which was an increase over 2000 exports by 112% (weight) and 93% (value) as shown in table 6.9.

Table 6.9 Quantity and value of cotton exported from Thailand, 2002–2006

2002		2003		2004		2005		2006	
Quantity	Value	Quantity	Value	Quantity	Value	Quantity	Value	Quantity	Value
5,856	5.3	11,001	8.7	7,931	6.6	7,412	5.8	8,048	5.3

Quantity: Tons
Value: \$ million

Source: Office of Agricultural Economics in cooperation with the Customs Department (HS 5201, 5202, 5203).

In 2005, the production of cotton yarn was 400,000 tons out of which the Thai textile industry exported only 54,217.9 tons, amounting to approximately \$149.41 million as shown in table 6.10 and figure 6.25. The remainder was used for fabric production.

Table 6.10 Quantity and value of cotton yarn exported from Thailand, 2001–2005

2001		2002		2003		2004		2005	
Quantity	Value	Quantity	Value	Quantity	Value	Quantity	Value	Quantity	Value
29,563.8	83.70	39,039.7	94.82	46,394.4	122.56	44,807.3	132.72	54,217.9	149.41

Quantity: Tons
Value: US\$ million

Source: Information and Communication Technology Centre in cooperation with the Customs Department.

Figure 6.25: Quantity of exported cotton yarn

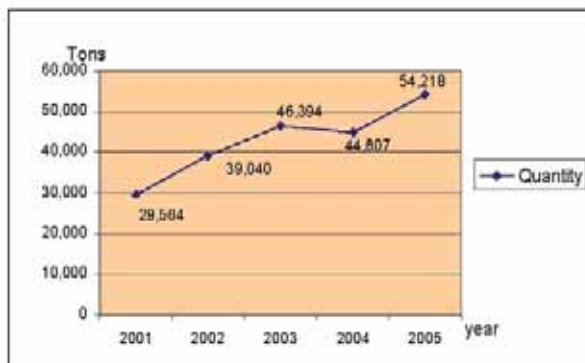

Tariff and non-tariff requirements in the domestic market

Taxation

Thailand applies an MFN rate of 0% for all WTO Members on cotton (HS 5201). Imported cotton has been duty-free since 2003. The Thai textile industry and fibre producers agreed to make cotton duty-free, as the Thai textile industry promised to buy all domestic cotton produced.

Cotton import requirements

Pre-import procedures. All importers to Thailand must be registered with the registration division of the Bureau of Import–Export Certification (Department of Foreign Trade) and receive an importer’s card.

Documents needed for customs clearance.³⁶ The first stage in the import clearance procedure is to submit an import declaration (Customs Form 99 or 99/1) manually or through the EDI system.

The supporting documents required are:

- Two copies of invoice;
- Packing list (if any);
- An insurance premium invoice or other documents indicating the insurance premium;
- Release order (Customs Form 100/1 or 469);
- Bill of lading or air waybill;
- Customs value declaration form (Customs Form 170);
- Foreign Transaction Form 2 (F.T. 2) if the CIF value of the invoice exceeds 500,000 baht;
- Phytosanitary certificate;

³⁶ Customs Department Notification No. 58/2546: ‘Supporting Documents to an Import Declaration Form’.

- ❑ Certificate of origin;
- ❑ Other documents as required by Customs, e.g. documents detailing product mixtures, characteristics, guidelines on application of goods, catalogue, etc.

To import raw cotton into Thailand, a phytosanitary certificate is mandatory. The certificate must be issued by the proper government agency of the exporting country and should declare that the consignment is free from the following plant pests: *Heliothis virescens*, *H. zea*, *Ascochyta gossypii*, *Verticillium stakmanii*, *Puccinia stakmanii*, *Phymatotrichum omnivorum*.³⁷

It is important to take into account that the Thai Government bans the commercialization of all transgenic plants and their products, including cotton.

Actual import procedure³⁸

File an import declaration. The first stage of import clearance procedure is to submit an import declaration (Customs Form 99 or 99/1) manually or through the EDI system.

Prepare supporting documents. The second stage is to prepare the supporting documents prescribed in Customs Notification No. 58/2543.

Check the declaration and supporting documents. The third stage is to submit the import declaration and all supporting documents for examination by Customs at the port of entry (in case of EDI Red Line or manual system). The Customs officials will check whether the declaration is properly made out, and the supporting documents required are attached. In addition, Customs tariff, tax and duty calculation and valuation of goods are done at this stage.

Collect import duties and taxes. The fourth stage is payment of the applicable taxes and/or depositing a guarantee. There are currently four ways to pay import duties and taxes:

- ❑ Payment at the Customs Department. Importers make payment at the cashier division at the port of entry. Customs then issues a payment receipt to be used for cargo inspection and release at relevant warehouses.
- ❑ Electronic funds transfer via BAHTNET. Importers have been allowed to instruct their commercial banks to transfer payment, through the BAHTNET system, to the Customs Department since 1 January 1998.
- ❑ Electronic payment at Krung Thai Bank (teller payment system).³⁹
- ❑ Electronic funds transfer via electronic data interchange (EDI). Under this automated system, electronic payment is made between tax/duty payers (importers and exporters), broker banks (the banks where importers and exporters have accounts), Customs banks, and the Customs Department.

Inspect and release cargo. The last stage is to inspect and finally release cargo from Customs custody. Importers submit the verified declaration together with the payment receipt at the appropriate warehouses. Customs inspectors then inspect the imported cargo against the declaration made. If the cargo inspected corresponds to the declaration made, the customs inspectors will record the inspection result in the computer system and release the cargo to importers. The process of cargo inspection under the manual entry system is different from that under the EDI system. In manual cargo clearance, shipments are inspected

³⁷ Department of Agriculture: 'Conditions of importation of cotton seed to the Kingdom'.

³⁸ Customs Department.

³⁹ The Customs Department and Krung Thai Bank have been interfaced since 1 September 2000.

on a random basis as specified by the Customs Department. The EDI system, however, requires that the cargo under profile be examined as deemed appropriate regardless of the random rate specified by the Customs Department for manual entries (Customs Notification No. 47/2543).

Expected market developments

The Thai Textile Manufacturing association has projected that Thailand will require about 500,000 tons of cotton by 2010. In 2010, the Thai textile industry is likely to import almost 500,000 tons of cotton as local production will have declined due to a lack of support.

In Thailand, 90% of all spinning factories use imported cotton. Only small and medium-sized factories use local cotton. Spinning factories contact local and international agencies to import cotton.

Case studies of large national cotton consumers

In 2005, 72% of Thai spinning mills imported cotton from West Africa. In 2006, this proportion was decreasing, and only 60% of Thai spinning mills imported cotton from West Africa. Thai mills encountered several problems in the import of cotton from West Africa, such as scarcity, unavailability, delayed transportation, low quality and contamination by plastic strings. Similar findings were also confirmed for cotton from East Africa.

African Cotton is perceived by Thai entrepreneurs as having the following characteristics:

- Moderate quality;
- Moderate price;
- Long staple cotton; and
- High contamination.

Thai textile mills requested African cotton producers to provide more transparent information on all aspects of cotton, and noted that prices should be more attractive. Thai entrepreneurs noticed a distinct difference between African and United States cotton: United States cotton is perceived as being better quality than African cotton in terms of whiteness, fibre evenness and fibre fineness.

Normally, Thai spinning mills purchase cotton through an agent, because it is convenient and easy. The first decision factor for purchasing cotton is based on fibre length, cotton quality, impurity, fibre strength, and colour of cotton lint. Thai spinning mills determined their standard requirement for imported cotton as 1.125" length, fibre fineness 3.5–4.9 micronaire, and fibre strength 28–30 grams per tex.

Eighty per cent of Thai spinning mills have and use fibre-testing instruments (High Volume Instruments). Spinning mills that are not equipped with instruments rely on the inspector's experience. Some large companies use both methods. Testing and inspection are done at the spinning mills.

Most of the mills do not determine the standards of cotton bales and labelling. The lead-time for purchasing cotton is two months. The purchase order will generally depend on the market situation as well as the market price.

In-depth interviews on penetrating the Thai cotton market

Company A

Registered capital	THB 9 billion
Employees	1,200
Type of business	Manufacturer: yarn; woven fabric; bleaching; 100% bleaching cotton gauze product Supplier: textile materials – sells own manufactured goods
Yarn manufacture	Spinning: traditional ring 100,000 spindles, compact K-44 5,000 spindles, O.E. 5,000 rotors Fibre content: cotton 100%, polyester cotton blends (TC, CVC) Products: grey yarn, warp yarn, weft yarn, knitting yarn, hosiery yarn
Source of cotton	The company's 100% imported cotton lint comes from the United States (40%), Australia (35%) and Pakistan (20%). The amount of each order varies, depending on the available stocks. The total amount of cotton required monthly is approximately 1,600–1,700 tons.
Supplier	Cotton is directly ordered through brokers or United States-based Internet sites such as that of Cotton Incorporated.
Cotton requirement	The company requires 1–1.53" length, fibre fineness 3.5–4.9 micronaire, fibre strength 30–31 grams per tex.
Attitude towards cotton from West Africa	<ul style="list-style-type: none"> • West African cotton is long staple, strong cotton. • The cotton harvesting method is poor. • It is difficult to extract the cotton seed and there are a lot of impurities. • The price is very attractive. • The cultivation of cotton is uncertain.
Recommendation for penetrating the Thai market	The most important factor is to reduce cotton contamination. After-sales service should be made available for more than a year. If problems occur, it can be very difficult to contact the cotton supplier to resolve problems. The company suggests that the best marketing method for African cotton would be to go through an agency or cotton trading company. Direct selling can generate problems relating to qualification, insurance and product claim.

Company B

Registered capital	THB 450 million
Employees	750
Type of business	Manufacturer: yarn; dyeing; melange top-dyed yarn Supplier: textile materials – sells own manufactured goods
Yarn manufacture	Spinning: OE rotor Fibre content: cotton 100%, polyester 100%, acrylic 100%, rayon 100%, modal 100%, polyester cotton blends (TC, TVC), polyester rayon (TR), etc. Type: Staple yarn: carded, open-end Products: warp yarn, weft yarn, knitting yarn, dye yarn, hosiery yarn, knitting and weaving use, nep and slub effect, greige yarn
Source of cotton	The company consumes 30% local cotton and 70% imported cotton. Of the imported cotton, 35% comes from West Africa. India and the Russian Federation are also cotton sources for this company. The cotton from West Africa does not pose problems even with its high contamination level, as the fibres are dyed prior to spinning. Their total purchase order is 3,000 tons per year, which is used for spinning cotton yarn using open-end spinning. Yarn counts are 20s–40s. Of the product, 80% is domestically used or sold; the remainder is exported.
Supplier	With a lead-time of one month, local cotton producers order directly from familiar producers to contact foreign producers.
Cotton requirement	The company requires 1.125" lengths, fibre delicate 3.5–4.9 micronaire, fibre strength 26–28 grams per tex.
Attitude towards cotton from West Africa	<ul style="list-style-type: none"> • It is long staple cotton, and strong. • It is high-quality cotton. • It is cultivated through out the year. • It is around 5% cheaper than cotton from the United States.
Recommendation for penetrating the Thai market	The most important matter is a reduction in cotton contamination.

Company C

Registered capital	THB 150 million
Employees	200
Type of business	Manufacturer: yarn; woven fabric; technical textiles
Yarn manufacture	Fibre manufacture: cotton wool, cotton ball, cotton sliver, gauze100%
Source of cotton	In 2006, the company purchased 90% of its cotton from the United States, Australia and Zimbabwe, while 10% was locally purchased. African cotton is regarded as being longer than United States cotton and whiter than others. Thai cotton is moderate in quality but production is insufficient. The company prefers African cotton due to a better offer than that from the United States. Previously, they also used cotton from Togo, but this cotton is very red, which adds to the cost due to cleaning. Chinese cotton is regarded as cleaner but not so strong. The quality of Indian cotton is good but there are communication problems between suppliers and the company.
Supplier	The company finds it convenient to employ a foreign broker who is familiar with the cotton characteristics of various countries.
Cotton requirement	The company requires 1.125" length, fibre fineness is 4 micronaire, fibre strength 28 grams per tex.
Attitude towards cotton from West Africa	<ul style="list-style-type: none"> • Quality of cotton in each year is inconsistent due to climate.
Recommendation for penetrating the Thai market	Improvement of cotton impurities should be given the first priority.

Turkey

Turkey, a net importer of cotton since 1993, with an annual production fluctuating around 900,000 tons, and consumption exceeding 1.5 million tons, has to import 700,000–750,000 tons of cotton annually to meet the demands of its strong textile and clothing industry. The majority of Upland cotton imports come from the United States, Greece, the Syrian Arab Republic, Uzbekistan and Turkmenistan, while long and extra-long staple (ELS) cotton imports come from Egypt and the United States.

Because of its Customs Union with the European Union (EU), Turkey has adopted zero tariff rates for cotton, while the Generalized System of Preferences (GSP) and most-favoured nation (MFN) rates have been lowered considerably and made identical with the EU rates for industrial products. Turkey's exports of textiles and clothing products have been increasing even since the beginning of the quota-free era, largely due to inherent strengths of its domestic textile and clothing industry.

Two scenarios have been prepared to reflect possible market prospects for cotton for the next 10 years, assuming an incremental domestic production growth as well as sizeable imports in both scenarios.

LDC exporters need to improve their standards, eliminate or minimize contamination and supply consistent quality in order to penetrate the Turkish cotton market. LDCs should also continue marketing their cotton through international trading companies, until importing countries become adequately familiar with the characteristics of their cotton.

The structure and characteristics of the domestic cotton market: a macro view

Cotton grown in Turkey is the *Gossypium hirsutum* 'Upland type', whose lint characteristics have proved to be suitable for most textile applications. Various attempts to grow long staple cotton have so far produced limited success. Therefore, even at times of self-sufficiency in quantity for Upland cotton, there will always be a need by the Turkish textile industry to import long and extra-long staple cotton.

Cotton has traditionally been grown in the Aegean, Antalya, Çukurova and south-east regions. According to the 2001 census, around 130,000 farmers are engaged in cotton farming, with an average yield of around 1,350–1,400 kg per hectare, making Turkey the country in the world with the highest yields.

During the last 60 years, cotton production in Turkey has increased 24-fold, while the increase in world production has been just 5.3. Similarly, domestic cotton consumption has increased 36-fold, while the world consumption increase has been only 5.35.

Cotton imports have become a growing necessity to meet the increased demand from the booming textile and garment sector, especially after 1993, when Turkey became a net cotton importing country and cotton exports declined to low volumes.

The Agricultural Sales Cooperative Unions (ASCUs) play a considerable role in the cotton sector, with Taris (Aegean), Antbirlik (Antalya) and Çukobirlik (Mediterranean and south-east) providing agricultural inputs (i.e seeds, fertilizers, chemicals) and finance to their members, buying the seed cotton and, after ginning, selling the lint cotton in the domestic or export markets.

Market size and prices

The annual market size of lint cotton alone is around 1.5 million tons, which translates into approximately \$2 billion in value, assuming an average cotton price of 60 cents per pound.

During harvesting and ginning, seed cotton prices are established in the local markets, reflecting the price at which seed cotton is traded between cotton growers and ginners. Seed cotton is also bought by intermediaries, who subsequently sell it to nearby ginners. Price formation in seed cotton is largely linked to the prevailing lint cotton prices and cotton seed oil prices.

Until 1993 Governments implemented a *support price policy* through ASCUs. Since 1998 growers have been receiving 'Premium (bonus) payments', which contribute significantly to the sustainability of domestic production.

Harvesting takes place between August and November. Ginning operations commence in late September and may last until March or April in the following year. Ongoing seed cotton prices are recorded and made publicly available by local commodity exchanges.

Figure 6.26: Marketing channels for seed and lint cotton in Turkey

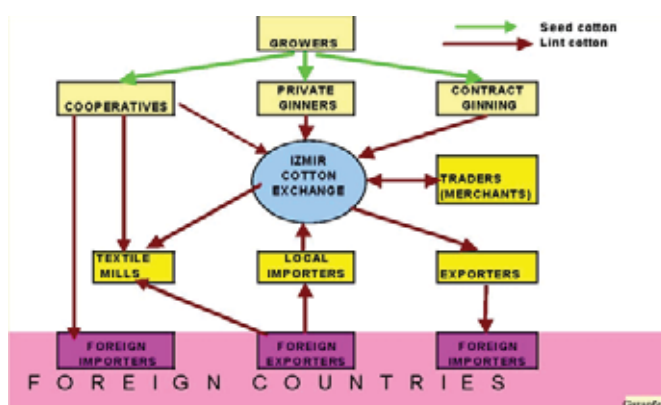

Figure 6.27: Comparison of Std.1 Aegean cotton domestic prices with the Cotlook A Index, 1 September – 31 August 2006



Figure 6.26 is a simplified diagram showing the marketing channels of cotton in Turkey. Main players in the market are ASCUs, spinners and traders. There exists a well-functioning spot market for lint cotton in the Izmir Mercantile Exchange (IME), which has been active since 1891. The trading pit operates by an 'outcry' system, each session lasting only 10 minutes on each working day. Although trading takes place mainly on Aegean (Izmir) cotton, other domestic growths, as well as cotton from neighbouring countries, can also be traded. Lint cotton prices established at the IME are registered and announced daily.

Since the beginning of the 1990s, Turkey has maintained a totally liberalized cotton trading environment with no restrictions on imports or exports. Prices in the domestic cotton market develop in close correlation with world market prices, the latter being represented by the Cotlook A Index. It should be emphasized that domestic cotton market prices have generally been higher than the Cotlook A Index values (see figure 6.27).

Cotton qualities supplied by the domestic industry

According to current official Turkish standards, domestic cotton is classed based on three parameters, which are fibre length, colour grades and trash content, and on production regions.

Most of the harvested crop is roller-ginned, while the remaining crop (roughly 10%–15%) is diverted to saw-gins, which are mostly owned and operated by the three ASCUs. Recent investments by Tariş in saw-ginning facilities in some cooperatives enabled significant increases in saw-ginned cotton. Use of saw-gins is becoming more popular as the number of harvesting machines has increased considerably, especially in the Aegean region, where the cost of hand-picking has become prohibitively expensive.

In a normal crop year, the percentage of Std.1 (white) cotton will be 70%–85%, whereas the amount of HB 1 (light spotted) will be roughly 10%–15%, with the remainder covering the other qualities.

Cotton qualities supplied from abroad and from which countries

Most imported cotton is also of 'Upland type', for which there exists a large deficit. Since the price of imported cotton is generally lower than the price of domestic cotton, spinners always try to secure lower-priced imported cotton for a given quality. Furthermore, cotton with little or no contamination takes priority for spinners producing yarn for export or manufacturing fabric that is ultimately destined to foreign markets as fabrics or garments. Lastly, there is also a good demand for Upland cotton of lower quality so long as the yarn spun either from that cotton or from its suitably arranged blends meets basic quality expectations. This is especially true for cotton types which are extensively used for spinning coarse count open-end or ring-span yarns, which are used for production of denim, towelling, bed linen, etc.

The majority of Upland cotton imports come from the United States, Greece and the Syrian Arab Republic. Cotton imports from Uzbekistan, Turkmenistan, Azerbaijan, Tajikistan and recently from Brazil, Australia and India are all 'Upland cotton' of similar grades.

Continuing upwards on the quality scale, there also exists a growing demand for high quality Upland cotton, which is used for spinning very good quality combed or carded yarns of fine counts, such as Ne 40s or 50s. 'Acala' is the cotton type imported for this purpose. It is mainly imported from the United States (California) and Israel.

	1996	1997	1998	1999	2000	2001	2002	2003	2004	2005	2006	TOTAL
United States	9,797	96,324	137,793	31,653	197,900	186,777	308,373	355,570	336,454	494,052	416,271	2,570,964
Greece	52,334	88,908	56,713	104,353	130,113	117,446	117,378	100,292	129,933	142,489	165,171	1,205,130
Syrian Arab Republic	9,099	25,877	48,769	19,603	66,699	37,453	33,105	48,062	29,095	60,331	35,801	413,894
Turkmenistan	47,197	27,981	12,519	20,588	52,876	33,030	32,465	21,876	27,345	13,560	42,285	331,722
Uzbekistan	21,038	43,773	50,747	30,861	32,526	11,256	8,668	6,115	17,052	11,257	21,181	254,474
Israel	8,895	20,239	16,906	18,894	18,675	3,892	2,296	2,256	9,225	7,051	3,019	111,348
Azerbaijan	3,195	11,355	18,969	14,393	13,951	10,458	13,094	5,559	5,681	7081	8,998	112,734
Egypt	2,521	6,056	13,076	13,527	11,341	6,330	6,524	6,077	5,742	8,141	4,572	83,907
Mersin (FTZ)	5,073	5,724	2,056	10,308	4,251	2,353	524	4,283	15,382	3,857	13,615	67,426
Australia	9	11,823	14,100	1,221	58	8354	58	1,010	1,968	24	1,219	39,844
Brazil	0	0	298	0	1,611	8,768	5,004	298	1,644	7,849	2,409	27,881
Tajikistan	335	43	3,578	1697	6,122	1,643	1,981	3,169	2,033	118	3,461	24,180
Pakistan	0	135	122	0	10,097	6,221	348	21	247	281	77	17,549
India	0	6444	440	0	252	62	24	100	201	2,221	11,410	21,154
Subtotal	159,493	344,682	37,6086	267,098	546,472	434,043	529,842	554,688	582,002	758,312	729,489	5,231,827
<i>Others</i>	<i>8,085</i>	<i>11,776</i>	<i>3,602</i>	<i>10,060</i>	<i>20,312</i>	<i>20,116</i>	<i>10,721</i>	<i>1,909</i>	<i>3,106</i>	<i>17,200</i>	<i>20,776</i>	<i>178,043</i>
TOTAL	167,578	356,458	379,688	277,158	566,784	454,159	540,563	556,597	585,108	775,512	750,265	5,409,870

Source: Compiled from the statistical data of UFT, the Undersecretariat of Foreign Trade.

To complete the imported cotton types, one must also mention the long staple (LS) and extra-long staple (ELS) varieties, which are both used for production of very fine count yarns (Ne 60s or higher) up to 140s for carded or combed weaving or knitting applications, including very soft linen, towels, bathrobes, very high quality shirting fabrics and T-shirts. Countries from which this type of cotton is imported are Egypt (Giza) and the United States (Pima).

Turkey's cotton imports according to major exporting countries since 1996 are shown in table 6.11. Analysis of this table reveals that just five countries (United States, Greece, Syrian Arab Republic, Turkmenistan and Uzbekistan) cover almost 90% of imports. Annual imports from West and Central Africa have been around 5,000 tons.

What kind of cotton is exported and to which countries

The majority of exports are short and medium staple cotton from the south-east and Çukurova regions. Many importers prefer Turkish roller-ginned cotton because of its comparatively better staple length and strength, while others choose saw-ginned cotton because of its lower trash content.

Over the last 10 years, annual cotton exports from Turkey have been limited to 40,000-60,000 tons, most of which has been shipped to European countries or to Turkey's free trade zones (FTZs), from where it may be imported back to Turkey.

National production

National cotton production has been fluctuating at around 900,000 tons a year during recent years. There have been considerable production drops in the Çukurova and Antalya regions, and in part of the Aegean region, due to rising production costs and low-priced imports. Raising premium payments has not been very effective in encouraging growers to return to cotton cultivation in those regions.

Cotton production in the South-east Anatolian Project (GAP) area, however, has shown a gradual increase in parallel with the expansion of irrigated areas. This region is considered as the only region where production increases can be envisaged. Production costs in the GAP region are relatively low compared to the other regions, and thus more and more farmers in this region are taking up cotton cultivation.

Specific cotton quality requirements of the domestic textile industry

Domestic spinners' specific quality requirements can best be described as follows: cotton should have consistent quality parameters (colour, micronaire, staple length, strength, uniformity, elongation, etc.) and no contamination.

A regulation to eliminate or minimize the occurrence of contamination made it compulsory to use picking bags manufactured only from cotton. The ASCUs, especially Taris, have been on the forefront in the campaign against contamination, which is also a critical factor for imported cotton.

Analysis of the tariff structure of imports

The Customs Union with the EU was established on 1 January 1996. As a result, customs duties were eliminated between the EU and Turkey on industrial products, and on the industrial components of processed agricultural products including cotton. Turkey also adopted the EU's common customs tariffs for imports from third countries.

Turkey has had preferential schemes with European Free Trade Area (EFTA) countries since 1992, and has concluded free trade agreements with neighbouring and Mediterranean countries. Under these agreements a zero tariff rate is applied to cotton and also to industrial products.

The tariff rate for LDCs is also zero, while GSP and MFN rates are the same as EU rates.

Non-tariff requirements in the domestic cotton market

There are no non-tariff requirements in the domestic cotton market. Also there is no standardization control on imports. However, a 'control certificate' is required on exports, to signify that cotton is in conformity with the Turkish Standards.

There are also no specific packaging and labelling requirements on imported cotton bales. However, some mills would prefer cotton cloth on bale wrapping in order to minimize contamination.

Cotton is imported mostly on a CIF basis from the United States, Australia, West and Central Africa, the Commonwealth of Independent States, India, etc., but on an FOB basis from Greece.

Customs procedures

According to the current customs regulations, only a customs declaration form has to be presented to the customs authorities together with additional customary documents on importation and exportation. No import licence or special document is required on imports.

Expected market developments: demand and supply forecasts and future market prospects

Figure 6.28 indicates that there has been an accelerated increase in cotton demand between the 1991/92 and 2005/06 seasons, and that this demand has been satisfied by domestic cotton production and by increasing quantities of cotton imports.

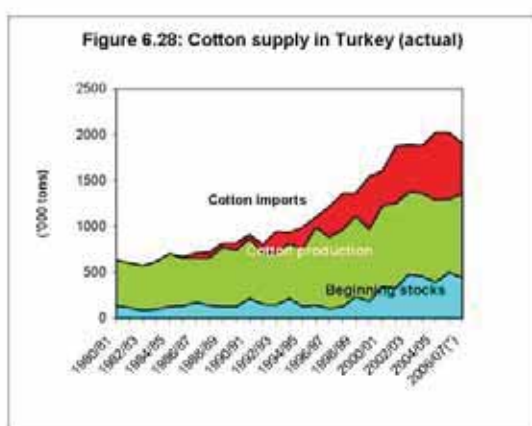

The elimination of quotas has not yet had a serious negative impact on Turkey's textile and clothing industry, when judged by export figures of recent years. This is due to the strengths of this sector, such as proximity to main markets (especially to the EU), ability to produce higher-value-added quality products and quick response time. It is widely believed that Turkey can maintain and even further improve its present position, provided a reasonable cost base can be sustained.

Two alternative cotton demand and supply projections have been developed for the next 10-year period. Projections in table 6.12 (scenario 1) assume that annual cotton demand will remain steady at 1.6 million tons while domestic cotton production will be raised incrementally, as a result of which cotton imports will decrease proportionately. Table 6.12 (scenario 2), however, reflects a more optimistic scenario in which an increase in demand is satisfied by incremental domestic production growth in addition to imports at a constant amount.

It is evident from both scenarios that the need for cotton imports is inevitable and that imported quantities will largely depend on the gap between demand and supply.

The domestic market: a micro view

Different players in the market

The number of domestic traders has decreased over the years. The gradual disappearance of Turkish cotton traders from the domestic and international marketplace has opened new avenues for cotton brokers or commission agents, who sell cotton for ginners and procure cotton for domestic mills. Around 15%–20% of the annual crop is now handled by three ASCUs, which, in addition to domestic sales, may also export their cotton.

In the case of cotton exports, commission agents can act on behalf of the overseas cotton importers, for whom they check the quality of cotton in the exporter's warehouse before shipment. On imports, these agents act for domestic textile mills, in which case they assume the responsibility of quality controls on behalf of the textile mills. They may even have to travel to the exporting country to check the quality before shipment.

Table 6.12 Cotton demand and supply projections for Turkey

SCENARIO 1: Assumption is that cotton demand will remain at 1.6 million tons, while cotton production will be raised incrementally, as a result of which imports will decrease proportionately.											
Seasons	Area ('000 ha)	Yield (kg/ha)	Beginning stocks ('000 tons)	Production ('000 tons)	Imports ('000 tons)	Total supply ('000 tons)	Consumption ('000 tons)	Exports ('000 tons)	Total demand ('000 tons)	Ending stocks ('000 tons)	Stock to use ratio* (%)
2006/07**	700	1,314	437	920	550	1907	1470	45	1515	392	25.9
2006/07***	700	1,228	437	860	600	1897	1500	47	1547	350	22.7
2007/08	680	1,323	350	900	700	1950	1550	50	1600	350	21.9
2008/09	690	1,333	350	920	680	1950	1550	50	1600	350	21.9
2009/10	700	1,342	350	940	660	1950	1550	50	1600	350	21.9
2010/11	710	1,352	350	960	640	1950	1550	50	1600	350	21.9
2011/12	720	1,361	350	980	620	1950	1550	50	1600	350	21.9
2012/13	730	1,369	350	1000	600	1950	1550	50	1600	350	21.9
2013/14	740	1,378	350	1020	580	1950	1550	50	1600	350	21.9
2014/15	750	1,386	350	1040	560	1950	1550	50	1600	350	21.9
2015/16	760	1,394	350	1060	540	1950	1550	50	1600	350	21.9
SCENARIO 2: This scenario reflects a more optimistic scenario, in which an increase in demand is satisfied by the incremental cotton production growth in addition to a constant level of imports.											
Seasons	Area ('000 ha)	Yield (kg/ha)	Beginning stocks ('000 tons)	Production ('000 tons)	Imports ('000 tons)	Total supply ('000 tons)	Consumption ('000 tons)	Exports ('000 tons)	Total demand ('000 tons)	Ending stocks ('000 tons)	Stock to use ratio* (%)
2006/07**	700	1314	437	920	550	1907	1470	45	1515	392	25.9
2006/07***	700	1228	437	860	600	1897	1500	47	1547	350	22.7
2007/08	680	1323	350	900	670	1920	1520	50	1570	350	22.3
2008/09	690	1333	350	920	670	1940	1540	50	1590	350	22.0
2009/10	700	1342	350	940	670	1960	1560	50	1610	350	21.7
2010/11	710	1352	350	960	670	1980	1580	50	1630	350	21.5
2011/12	720	1361	350	980	670	2000	1600	50	1650	350	21.2
2012/13	730	1369	350	1000	670	2020	1620	50	1670	350	20.9
2013/14	740	1378	350	1020	670	2040	1640	50	1690	350	20.7
2014/15	750	1386	350	1040	670	2060	1660	50	1710	350	20.5
2015/16	760	1394	350	1060	670	2080	1680	50	1730	350	20.4

* Ending stocks divided by consumption plus exports.

** First estimate.

*** Second estimate.

Cotton agents will continue to have an important role so long as buying and selling of cotton ‘on type’ or ‘on description’ are the agreed trading methods for acceptance of quality. It is believed that this role will significantly diminish when trading of cotton on quality parameters based on instrument testing of samples taken from homogenous bales becomes a widespread practice.

Cotton procurement practices in the market

Buying cotton in the cotton exchange (IME), where most of the large domestic mills have their own cotton brokers or commission agents, is one of the most common procurement methods.

Another method is for the seller to make a price offer, subject to acceptance of quality by the spinner. In this case, the seller will send one or more truckloads of cotton to the spinner’s premises for quality checking. Naturally, the consignment will be returned to the seller if the quality does not meet the buyer’s expectations. If the quality is approved, however, payment for the consignment will be made according to the agreed price.

The ASCUs, which usually have sufficient supplies of cotton to sell throughout the season, invariably make their domestic cotton sales in the IME.

Overseas exporters usually work with local commission agents, who serve as a link between the exporter and the Turkish mill. Commission agents also follow up the work related to transactions, such as monitoring the opening of the L/C, advising buyers on shipment details and quality control.

Business is often concluded via phone calls. Following the verbal commitment, the seller prepares a contract, in which the applicable arbitration body is also defined.

For United States cotton, offers may be ‘on call’ or on a ‘fixed price’ basis. The cotton quality would generally include grade (trash content), colour, staple length, micronaire and strength. Quality can be either ‘on description’ (described in terms of international standards) or ‘on type’ (exporter’s private type or sample). For United States cotton, a third alternative, ‘on Government Class’ (better known as ‘Green Card’), is also widely used. An inspection agent can also be asked to ascertain the quality and quantity.

Most cotton is imported to Turkey on ‘net landed weight final’ basis, in which case final settlement will be made on the basis of weight determined upon arrival. However, imports from Egypt are generally on the basis of ‘certified shipping weight final’. Both shipped and landed weights are determined by internationally recognized controllers.

Specific cotton contracts used in the market

In the case of imports, sellers’ contracts are usually accepted by Turkish buyers so long as the contract terms are in line with generally accepted international trading practices. In most contracts, rules of the internationally accepted arbitration bodies such as ICA are specifically referred to. However, the role of the Turkish commission agents is critical in the smooth execution of cotton contracts.

Cotton finance and payment regulations

Contracts concluded in the domestic market usually foresee immediate payment, unless agreed otherwise. For exports and imports, the preferred payment term is the L/C, with payment soon after loading or at a deferred time. However, parties may choose different payment terms; prepayment, cash against documents, 20% advance–80% on arrival are some of possible alternatives.

Mention should also be made of cotton financing tools, in particular United States GSM Credits. Under the GSM-102 scheme, cotton can be obtained on credit terms of up to three years. This scheme has been an important factor in raising United States cotton exports to Turkey over the last 10 years.⁴⁰

Consumer preferences for specific fibre types and blending

Turkish consumers generally prefer most of the clothing and textile products they use to be 100% cotton. Blended cotton is not very popular. Shirting fabric blended with polyester was preferred in the past because this blend had good wrinkle resistance. However, recent advancements in textile technology to produce wrinkle-resistant cotton fabric has considerably diminished the need for this type of blending.

Case studies of large national cotton consumers

A questionnaire was prepared and sent to 10 large textile mills, all of which had cotton yarn spinning facilities. From the replies received, it was interesting to note that:

- Nine companies preferred imported cotton because it was generally cheaper;
- For seven companies, fibre characteristics played a key role when buying cotton;
- Five companies looked for contamination-free cotton before anything else;
- For six companies, honouring of contracts was another area of great importance.

The four case studies below were prepared based on the information provided for two spinning mills and two vertically integrated large textile and clothing complexes, located in different parts of Turkey:

Company 1: Beyteks

Contact details	Tel: + 90 322 613 8091 Fax: + 90 322 613 8091 E-mail: beyteks@yahoo.com
Short description of the company and its status in the domestic market	Beyteks was established in Ceyhan, Adana, in 1993 for the manufacturing and domestic and export marketing of open-end yarns. Recently, new spinning equipment was added to the factory for the production of compact-ring spun yarns. Presently, the company is one of the leading cotton yarn producers in Turkey.
Amount of cotton used and share of imports	Present cotton use: 12,000 tons/year. Share of imported cotton: 90%.
Types of yarn produced	Super open-end yarns with Ne counts 10/1 to 30/1. In compact ring spinning, combed yarns for knitting with Ne counts from 20/1 to 40/1.
Cotton qualities sourced	Upland, middling, strict low middling, good middling.
Cotton qualities possessed	Same as above.

⁴⁰ See Jim Higgiston, www.cottoninc.com/2005EFSCConferencePresentations_Turkey/.

Cotton sources	Almost 90% of cotton used is imported from a cotton shipper in the United States.
Sourcing methods	Through a commission agent in Turkey.
Major requirements with regard to cotton exporters	To show due attention to problems when they arise. To respect the shipment dates. To respect contractual rights and obligations.
Recommendations on how best to penetrate the domestic cotton market and to start applying to spinning/textile mills	Study carefully the spinner's cotton needs. Provide cotton that matches the spinner's needs. Show due attention to any problems and act without delay. Establish trust and good business dialogue.

Company 2: Menderes Tekstil A.Ş.

Contact details	Tel.: +90 258 429 12 12 Fax: +90 258 429 12 30 Website: www.menderes.com
Short description of the company and its status in the domestic market	Menderes Tekstil was founded in Sarayköy, Denizli, in 1958. The company started by ginning and coarse-count cotton yarn spinning for the domestic market, making its biggest leap forward after 1980s. The accelerated growth of this successful textile company is evident in its use of state-of-the-art technology and modern facilities. Menderes Tekstil, which is part of Akça Holding, houses eight integrated production facilities on its 200,000 m ² (50 acre) site and employs around 4,000 highly skilled workers. After almost 50 years' experience in textile industry, specializing in home linens and fabrics, this company is one of the largest and leading home textiles producers and exporters not only in Turkey but also in the world.
Amount of cotton used and share of imports	Present cotton use: 36.000 tons/year. Share of imported cotton: 90%–95%.
Types of yarn produced	Open-end, with Ne counts 8/1 to 30/1.
Cotton qualities sourced	Upland, low middling, strict low middling, (cotton should be free from contamination); fibre length >28 mm; micronaire 3.5–4.5; strength >30 gpt.
Cotton qualities possessed	Similar to above.
Cotton sources	From the United States.
Sourcing methods	Company imports directly through a broker in the United States.
Major requirements with regard to cotton exporters	To ship cotton according to agreed specifications.
Recommendations on how best to penetrate the domestic cotton market and to start applying to spinning/textile mills	Carefully study the characteristics and expectations of the domestic market and make offers at attractive prices.

Company 3: Iskur A.Ş.

Contact details	<p>Tel.: +90 344 236 20 00 Fax: +90 344 236 20 02 E-mail: mail@iskur.com Website: www.iskur.com</p>
Short description of the company and its status in the domestic market	<p>Iskur Tekstil and Enerji A.Ş. was established in K. Maraş in 1973, with its initial activities limited to cotton trading, ginning and cotton seed oil production. With the investments made during the 1980s and 1990s, the company expanded in the production of open-end and ring yarns with 100% cotton, cotton/polyester and cotton/viscon blends, as well as knitted fabric, dyeing and finishing facilities. Iskur A.Ş. exports one-third of its production to world markets, mainly to the EU. The company has 6 factories, with a total area of 60,000 m², 15,624 spindles (for ring yarn) and 6,528 rotors (open-end yarn), production capacity 15 tons/day knitted fabric and 20 tons/day dyeing and finishing, all equipped with advanced machinery.</p>
Amount of cotton used and share of imports	<p>Present cotton use: 20,000 tons/year. Share of imported cotton: 60%.</p>
Types of yarn produced	<p>Open-end with Ne counts from 4/1 to 34/1. Carded for weaving: 4/1 to 40/1. Carded for knitting: 4/1 to 40/1. Combed for weaving: 4/1 to 60/1. Combed for knitting: 4/1 to 60/1. Also knitted fabric.</p>
Cotton qualities sourced	<p>Upland, good middling, middling, strict low middling; Supima for fine count combed yarns.</p>
Cotton qualities possessed	<p>Only Upland types.</p>
Cotton sources	<p>United States, Uzbekistan, Syrian Arab Republic, South Africa.</p>
Sourcing methods	<p>Direct imports, sometimes through a commission agent.</p>
Major requirements with regard to cotton exporters	<p>To be present to solve problems when they arise. To stick to shipment dates. To respect contractual rights and obligations.</p>
Recommendations on how best to penetrate the domestic cotton market and to start applying to spinning/textile mills	<p>Understand the expectations of the spinner. Provide cotton with matching properties and no contamination. Show due attention to any problems and act without delay.</p>

Company 4: Kipaş Holding

Contact details	Tel: +90 344 236 38 00 Fax: +90 344236 33 07 E-mail: kipas@kipas.com.tr Website: www.kipas.com.tr
Short description of the company and its status in the domestic market	The history of Kipaş Holding is relatively short, dating back to 1984 when a small company started producing open-end cotton yarns with a few rotors. These operations expanded rapidly, especially in the 1990s, with the addition of other production facilities, most of them in K. Maraş, a province renowned for its entrepreneurial skills and hard-working character. Major subsidiary companies under the holding are Kipaş Fabric (fabric for shirting, home textiles, corduroy, garments, etc.) Bozkurt Garments (men's, women's, children's clothing, jeans, etc.), Kipaş Denim (denim fabric, ring yarn), Mipsan (open-end and ring yarns), Erdem Textile (yarn and fabrics), Kipaş Marketing. Kipaş Holding is among the leading textile holding companies.
Amount of cotton used and share of imports	Present cotton use: 90,000 tons/year. Share of imported cotton: 60%.
Types of yarn produced	Open-end yarns with Ne counts 5/1 to 30/1. Carded for weaving: 6/1 to 36/1. Carded for knitting: 12/1 to 36/1. Combed for weaving: 20/1 to 80/1. Combed for knitting: 20/1 to 60/1.
Cotton qualities sourced	Middling, strict middling, strict low middling (with competitive prices); no contamination. Long staple, extra long staple (Supima).
Cotton qualities possessed	Only Upland types.
Cotton sources	United States, Turkmenistan, Greece, Azerbaijan.
Sourcing methods	Prefers direct importing, but also uses a commission agent.
Major requirements with regard to cotton exporters	To provide good service from sales to delivery. To stand behind the product sold. To give serious consideration to the buyer's complaints.
Recommendations on how best to penetrate the domestic cotton market and to start applying to spinning/textile mills	Show due attention to any problems and act without delay. Provide good service from sales to delivery. Stick to the shipment dates.

Possible niche markets and product groups to be targeted

Turkey has been regarded as the pioneer in producing organic cotton, which first started in Kahramanmaraş province in the 1989/90 season. Production spread rapidly to Sanliurfa, Diyarbakir, Hatay and Manisa Provinces, making Turkey the leading producing and exporting country in organic cotton. In 2006/07 season, there were around 350 registered organic cotton growers, with 7,500 hectares under contract farming.⁴¹ Exports of organic cotton yarn, textiles and clothing have also increased during recent years.

Price differentials for organic cotton are narrowing in world markets, with cheaper offers coming from low-cost countries, Turkey may also need to import organic cotton for its growing textile and clothing market.

Existing national support schemes that could be utilized to assist cotton-exporting LDCs to penetrate the Turkish market

Not only can LDCs export cotton to Turkey at zero tariff rate, but the zero rate also applies to cotton-related product groups. Turkey has also been implementing its African Development strategy, in which technical cooperation and trade promotion activities comprise the primary fields. In this context, Turkey aims at providing support to its SMEs to enable them to penetrate into African countries by direct trade and investment, including the promotion of imports from African countries of raw materials and intermediate goods needed for its industries.

Recommendations to LDC cotton exporters for promoting exports to Turkey

Consistent quality, little or no contamination, attractive GSM credit facilities (for United States cotton), the availability of cheaper priced cotton from neighbouring suppliers (Greece, the Syrian Arab Republic, Uzbekistan, Turkmenistan, etc.) are given as determining factors for Turkey's rising imports from these countries.

The Turkish industry's experience with West and Central African cotton is, however, relatively new. Cotton is imported to Turkey from LDCs generally through international cotton trading companies, some of which have offices in those countries. The main reasons for preferring to trade with intermediary companies, instead of purchasing direct from the country of origin, are that the international traders:

- Are well known and often trusted by both sides;
- Can prepare and offer the most suitable cotton for the importer, since they are familiar with importers' exact needs;
- Can arrange and follow up shipments more efficiently and with less cost;
- Can solve conflicts more easily and quickly.

The overall assessment of Turkish commission agents and textile mills of cotton from LDCs is mixed. Inconsistency of quality, contamination, and long and

⁴¹ Records of the Ministry of Agriculture and Rural Affairs, 2006.

costly shipments are some of the problem areas mentioned.⁴² The recommendations to LDC exporters would be to minimize contamination, improve quality parameters, develop common standards and allow introductory price differentials until importers are well informed and experienced with their cotton.

Cotton classification parameters in Turkey

Classification according to the fibre length

- ❑ Short fibre cottons (*Gossypium herbaceum L.*, *Gossypium arboreum L.*). Length of the fibre is shorter than 19.05 mm.
- ❑ Medium fibre (Upland) cotton (*Gossypium hirsutum L.*). Length of the fibre is 19.05–34.54 mm. Presently, the majority (99.5%) of cotton produced in Turkey is Upland cotton.
- ❑ Long fibre cottons (*Gossypium barbadense L.*). Fibre length is longer than 30.54 mm.

Classification according to colour range and percentage of foreign materials

- ❑ White class. Unspotted cottons containing the natural colour of the type. It is subdivided into different types, such as Standard Extra, Standard 1, Standard 2, Standard 3, Standard 4 and Standard 5.
- ❑ Light spotted class. Light spotted (HB) because of rain, harvest and storage conditions. It is subdivided into different types, such as HB 1, HB 2, HB 3, HB 4 and HB 5.
- ❑ Coloured type. Cotton transformed to very light brown, light brown, brown and dark brown as a result of the ginning of the seed cotton which has been subjected to fermentation. It is subdivided into different types, such as colour 1, colour 2, colour 3 and colour 4.
- ❑ Outside any type category: Any cotton not fitting into any of above categories.

Colour grades of Turkish Upland cotton, as measured by HVI tests, together with foreign matter contents for roller-ginned and saw-ginned cotton, are shown in table 6.13.

Classification according to production area

For *roller-ginned* Upland cotton:

- ❑ Turkey–Aegean. This covers medium fibre (generally 1 3/32" and above) roller-ginned cottons produced in the Aegean production area. Traditionally, this is the best-known Turkish cotton type because of its very good fibre characteristics. Presently, the annual production of Aegean cotton is around 200 thousand tons, which is about a quarter of Turkey's total crop.
- ❑ Turkey–Aegean Type. This covers medium fibre (1 3/32" and above) roller-ginned cottons produced in areas other than the Aegean production area, such as in Antalya (south-west), Hatay, K. Maraş (south) and Diyarbakır, Ş.Urfa, Adıyaman (south-east).

⁴² Personal communication with commission agents, importers and textile mills importing cotton from LDCs, 2006.

- Turkey–Çukurova. This covers medium fibre (generally 1 1/16") roller-ginned cottons produced generally in the provinces of Adana, Mersin and Osmaniye.

For *saw-ginned* Upland cotton, there exists only a single standard applicable to all saw-ginned cottons, irrespective of where they have been grown. Test results for cotton of various origins are given in table 6.14.

Class	Type	Range of colour	Percentage of foreign material (%)	
			Roller-gin	Saw-gin
White	Standard extra	11-1, 11-2, 11-3, 11-4	0–4	0.1
	Standard 1	21-1, 21-2, 21-3, 21-4	4–5.2	0.1–1.8
	Standard 2	31-1, 31-2, 31-3, 31-4	4.6–6.6	1.2–2.4
	Standard 3	41-1, 41-2, 41-3, 41-4	5.5–7.7	1.8–3.2
	Standard 4	51-1, 51-2, 51-3, 51-4	6.6–9.0	2.4–4.0
	Standard 5	61-1, 61-2, 61-3, 61-4	7.5–10.5	2.9–5.3
Light spotted	HB 1	31-1, 31-2, 31-3, 31-4	4–5.6	1.2–2.4
	HB 2	41-1, 41-2, 41-3, 41-4	5.5–7.7	1.8–3.2
	HB 3	51-1, 51-2, 51-3, 51-4	6.6–9.0	2.4–4.0
	HB 4	61-1, 61-2, 61-3, 61-4	7.5–10.5	2.9–5.3
	HB 5	71-1, 71-2, 71-3, 71-4	8.8–12.5	4.3–6.9
Coloured type	Coloured 1	24-25	3.6–5.6	1.2–2.4
	Coloured 2	34-35	4.5–6.7	1.8–3.2
	Coloured 3	44-45	5.4–7.8	2.4–4.0
	Coloured 4	54-55	6.3–9.3	2.9–5.3

* Applications are arbitrary.

Location\Parameters	RG/SG	Grade	Mic	Length	Strength	Uniformity	Rd	+b
Southeast								
DIYARBAKIR	RG	HB 2	3.6	32.13	33.7	85.3	75.9	7.0
DIYARBAKIR	RG	HB 1	3.86	29.93	35.0	87.0	75.5	7.1
DIYARBAKIR	RG	Std 1	4.38	28.52	34.4	87.3	74.9	7.2
DIYARBAKIR	RG	Std 1	4.17	31.17	35.2	87.2	75.7	7.3
DIYARBAKIR	RG	Std 1	4.27	30.73	35.3	87.3	75.8	7.4
DIYARBAKIR	RG	Std 1	4.30	30.25	36.6	87.0	78.5	7.5
DIYARBAKIR	RG	Std 1	4.40	29.98	35.5	87.5	75.1	7.6
AKÇAKALE	RG	HB 2	4.21	29.99	33.9	86.6	71.4	7.7
ŞANLIURFA	RG	Std 1	4.64	29.66	33.1	86.4	75.7	8.1
South+ Çukurova								
KIRIKHAN	RG	HB 1	4.48	28.83	35.8	86.8	70.7	7.3
KIRIKHAN	RG	Std 1	4.55	28.69	33.8	86.7	75.0	7.6
CEYHAN	SG	HB 3	3.40	29.16	27.0	83.9	69.0	8.0

Table 6.14 (cont'd)								
Location\Parameters	RG/SG	Grade	Mic	Length	Strength	Uniformity	Rd	+b
CEYHAN	SG	Extra	4.49	26.54	29.0	83.1	75.1	7.3
CEYHAN	SG	Std 1	4.71	27.91	26.0	82.6	77.0	8.1
CEYHAN	SG	HB 1	4.67	28.81	31.6	83.2	69.2	8.1
CEYHAN	SG	HB 2	4.52	29.14	31.4	87.1	75.2	7.4
Aegean 2005/06								
EZINE	RG	EXTRA	4.9	28.71	30.9	84.1	77.2	8.1
AKHISAR	RG	Std 1	4.2	29.65	31.2	84.5	77.3	8.4
BERGAMA	RG	Std 1	4.5	30.7	29.9	84.9	74.9	8.3
DENIZLI	RG	Std 1	4.6	31.0	34.3	84.3	74.5	7.5
AYDIN	SG	Std 1	4.3	29.5	33.2	83.5	79.3	8.3
MENEMEN	SG	Std 1	4.5	29.7	33.5	83.6	79.3	8.6
SÖKE	SG	Std 1	4.4	29.6	32.6	83.2	78.3	8.2
AKHISAR	RG	HB 1	4.6	30.78	34.4	85.9	75.9	7.9
BERGAMA	RG	HB 1	4.7	30.90	30.1	84.7	75.4	8.4
DENIZLI	RG	HB 1	4.4	30.8	34.1	86.3	74.9	7.6
FETHIYE	RG	HB 1	4.1	31.0	35.3	86.0	73.4	8.2
SÖKE	SG	HB 1	4.0	29.3	30.8	82.4	74.5	8.3
AYDIN	SG	HB 1	4.1	28.6	30.2	80.3	73.5	8.4
Aegean 2004/05								
BERGAMA	RG	Std 1	3.6	30.1	28.4	83.6	78.6	7.9
BAYINDIR	RG	Std 1	4.1	30.3	32.7	84.3	79.0	8.1
MENEMEN	RG	Std 1	4.2	30.2	33.8	84.7	77.6	8.2
ORTACA	RG	Std 1	4.3	30.1	34.2	85.6	77.8	8.1
TEPEKÖY	RG	Std 1	4.2	30.8	33.7	85.2	77.9	7.9
SÖKE	SG	Std 2	3.5	29.2	31.1	62.0	69.6	7.7
SELÇUK	RG	Std 3	4.1	30.7	33.7	84.2	71.1	7.6

Source: Compiled from HVI data of: Çukobirlik related to 2005/06 crop of Southeast and Çukurova Cotton, Taris related to 2004/05 and 2005/06 crop of Aegean Cotton.

RG: Roller-ginned; SG: Saw-ginned; STD 1: Standard 1,2,3,4; HB 1,2,3,4,5: Light spotted.

Annex

Useful addresses

BANGLADESH

Top 20 spinning mills

Mother Textile Mills Ltd
Sena Kalyan Bhaban (15th Floor)
195 Motijheel C/A
Dhaka 1000

Tel: +880-2-9556483
Fax: +880-2-9556486
E-mail: textools@galbd.net

Monthly consumption (tons): 1,134

Square Textiles Limited
Square Centre
48 Mohakhali C/A
Dhaka 1212

Tel: +880-2-8817729-38
Fax: +880-2-8922263
E-mail: textiles@squaregroup.co

Monthly consumption (tons): 1,076

Arif Knitspin Limited
60 B.B. Road
Narayanganj 1400

Tel: +880-2-7615958
E-mail: nrgskb@dhaka.net

Monthly consumption (tons): 985

Tallu Spinning Mills Limited
Sena Kalyan Bhaban, Suite # 904 (9th Floor)
195 Motijheel C/A
Dhaka 1000

Tel: +880-27115248-51
Fax: +880-2-9564929, 9553880
E-mail: tvmbd@bol-online.com

Monthly consumption (tons): 972

Square Spinning Mills Limited
Square Centre
48 Mohakhali C/A
Dhaka 1212

Tel: +880-2-8817729-38
Fax: +880-2-8922263
E-mail: textiles@squaregroup.com

Monthly consumption (tons): 835

Prime Textile Spinning Mills Ltd
Sena Kalyan Bhaban (8th Floor)
195 Motijheel C/A
Dhaka 1000

Tel: +880-2-9564851-53, 7176013-4
Fax: +880-2-9564857, 7165831
E-mail: prime@bangla.net

Monthly consumption (tons): 774

Akij Textile Mills Ltd

Akij Chamber
73 Dilkusha C/A
Dhaka 1000

Tel: +880-2-9567713, 7169017-18,
9563008-09

Fax: +880-2-7168349, 9572293

E-mail: akijtex@akij.net

Monthly consumption (tons): 754

Jamuna Spinning Mills Ltd
Sena Kalyan Bhaban (12th Floor)
195 Motijheel C/A
Dhaka 1000

Tel: +880-2-9566091-93

Fax: +880-2-9554805, 9556409

E-mail: jamuna@galbd.net

Monthly consumption (tons): 742

Silver Line Composite Textile Mills Ltd
Silver Tower (17th Floor)
52, Gulshan Avenue, Gulshan-1
Dhaka 1212

Tel: +880-2-8852881-5

Fax: +880-2-9880606

E-mail: slg@bijoy.net

Monthly consumption (tons): 682

Pahartali Textile & Hosiery Mills
Ispahani Building, Agrabad
Chittagong

Tel: +880-31-716153-6, 711846

Fax: +880-31-710471

E-mail: import@ispahanibd.com

Monthly consumption (tons): 671

Naheed Cotton Mills Ltd
BSRS Bhaban (12th Floor), 12 Kawran Bazar C/A
Dhaka 1215

Tel: +880-2-9138186, 9132534, 9123142,
8120837

Fax: +880-2-9138187

E-mail: naheed@citechco.net

Monthly consumption (tons): 655

Keya Spinning Mills Ltd
108 Mosque Road
Old DOHS, Banani
Dhaka

Tel: +880-2-9297778-9, 9297029, 9297766,
9297301, 9297987

Fax: +880-2-8751012

E-mail: kgroup@keya-bd.com

Monthly consumption (tons): 652

Shameem Spinning Mills Ltd
Sena Kalyan Bhaban (12th Floor)
195 Motijheel C/A
Dhaka 1000
Tel: +880-2-9566091-93
Fax: +880-2-9554805, 9556409
E-mail: jamuna@galbd.net

Monthly consumption (tons): 621

Shameem Composite Mills Ltd
Sena Kalyan Bhaban (12th Floor)
195 Motijheel C/A
Dhaka 1000
Tel: +880-2-9566091-93
Fax: +880-2-9554805, 9556409
E-mail: jamuna@galbd.net

Monthly consumption (tons): 606

Karim Spinning Mills Ltd
Shena Kalyan Bhaban (15th Floor)
195 Motijheel C/A
Dhaka 1000
Tel: +880-2-9556481
Fax: +880-2-9556482

Monthly consumption (tons): 572

Prime Composite Mills Ltd
Shena Kalyan Bhaban (8th Floor)
195 Motijheel C/A
Dhaka 1000
Tel: +880-2-9564851-3, 7176013-4, 7175688
E-mail: prime@bangla.net

Monthly consumption (tons): 554

Madaripur Spinning Mills Ltd
1804 Sena Kalyan Bhaban (18th Floor)
195 Motijheel C/A
Dhaka 1000
Tel: +880-2-711943-6
Fax: +880-2-7114202
E-mail: eusof@citechco.net

Monthly consumption (tons): 552

Roshowa Spinning Mills Ltd
House-04, Road-09, Sector-04
Uttara Model Town
Dhaka 1230
Tel: +880-2-8962442, 8962445
Fax: +880-2-8962998
E-mail: roshowa@dhaka.net

Monthly consumption (tons): 525

Talha Spinning Mills Ltd
House-06, Road-01, Dhanmondi
Dhaka 1205
Tel: +880-2-9663393-5
Fax: +880-2-8619383

Monthly consumption (tons): 521

Mehmud Industries (Pvt.) Ltd
27 Dilkusha C/A
Dhaka 1000
Tel: +880-2-9564033
Fax: +880-2-956420
E-mail: agi@agni.com

Monthly consumption (tons): 507

Useful contact addresses

Ministry of Jute and Textiles
Bangladesh Secretariat, Dhaka
Tel: +8802 7167266
Fax: +8802 7168766
E-mail: motexsec@citechco.net

Bangladesh Garments Manufacturer and Exporters Association
BGMEA Building, 23/1, Pantha Path Link Road
Karwan Bazar
Dhaka
Tel: +8802 8113731, 8122119, 8115751
Fax: +8802 8125739
E-mail: info@bgmea.com

Bangladesh Knitwear Manufacturer and Exporters Association
National Plaza (4th Floor)1/G, Free School Street
Sonargaon Road
Dhaka
Tel: +8802 8610356
Fax: +8802 9673337
E-mail: bkmeadhk@bangla.net

Bangladesh Textile Mills Association
Unique Trade Centre (Level-8)
8, Panthapath, Karwan Bazar
Dhaka
Tel: +8802 8112361, 9143461
Fax: +8802 9125338
E-mail: btmea@citechco.net

Cotton Bangladesh
416 Road No. 30, New DOHS
Dhaka 1206
Tel: +880 2 885 0927, 989 1534
Fax: 880 2 989 1527
E-mail: info@cottonbangladesh.com

Export Promotion Bureau
TCB Building Karwan Bazar
Dhaka
Tel: +8802 9128377, 8151497
Fax: +8802 9119531

Agents and indenters

Abedsons
Fax: +8802-891-3101

Bancot Ltd
Fax: +8802-882-8390

BCD/Vallycot
Fax: +8802-831-1038

Buraich Corporation
Fax: +8802-966-9210

Cot Exim Limited
Fax: +8802-716-2964

Delkot Enterprises Ltd
Fax: +8802-955-1626, 8802-882-7204

DevCotton Int'l Ltd
Fax: +880-2-8356540

Dhaka Cotton Company
Fax: +8802-955-4187, 8802-956-9924

DSM Commodities
Fax: +8802-955-7526

Erfan Enterprises
Fax: +8802-934-9983

Fiber Links
Fax: +8802-913-4788

Greenfibers
Fax: +8802-989-1527

H. B Cotton
Fax: +8802-955-6479

Mas-Cot International
Fax: +8802-934-2587

The Cotton Valley
Fax: +8802-716-4713

Unicot
Fax: +8802-934-1658

Wellcot Int
Fax: +8802-934-9164

Some international companies selling cotton in the Bangladesh market

Adolph Hanslik Cotton Company, United States

Albrecht Muller-Pearse & Co, Germany (E-mail: amp-hongkon@attglobal.net)

Ancot, United States

Brüning, Anft & Co. GmbH, Bremen, Germany

Commodity Export Corporation, United States
(www.comexgroup.net)

Cotimtex.S.A. Switzerland
(E-mail: info@cotimtex.com)

D.M. Enterprise, India

Daewoo International Corporation, Seoul, Republic of Korea

Drachenberg Trading Company, United States

Dunavant S.A., Switzerland (www.denavant.com)

Goenka-Impex S.A., Switzerland (E-mail: impex@goenka.ch)

Indutech S.P.A. Italy (www.indutech.it)

International Cotton Trading Ltd, United Kingdom

Lonado International S.A., Switzerland

Louis Dreyfus Cotton Int. N.V., Belgium

Meezan Enterprises (Pvt.) Ltd, Pakistan

Naseem Enterprises (Pvt.) Ltd., Pakistan

Olam International Ltd., Singapore
(www.olamonline.com)

Otto Stadlander GMBH, Bremen, Germany

Paul Reinhart A.G. Switzerland (www.reinhart.com)

Plexus Cotton Ltd, United Kingdom
(www.plexus-cotton.com)

Rehmoumer and Co., Pakistan

Sicle Cotton Ltd, Switzerland

The Cotton Corporation of India Ltd
(www.cotcorp.com)

Uzdun A.G. Switzerland

Volcot America, Inc., United States

Weil Brothers Cotton Inc., United States

Weil Brothers Stern Ltd, United Kingdom

Wincot A.G. Switzerland

CHINA

Top 20 cotton textile mills

Shandong Weiqiao Pioneering Group Co. Ltd
34 Qidong Road, Weiqiao Town
Zouping County,
Shandong 256212
Tel: +86 543 4721652
Fax: +86 543 4721200
E-mail: wqcy@wqfz.com
Website: www.weiqiaocy.com

HuaFang Cotton Weaving Co. Ltd
1 South Renming Road, Tangqiao
Zhangjiagang, Jiangsu 215611
Tel: +86 512 58438001
Fax: +86 512 58441389
E-mail: office@hfang.com
Website: www.hfang.com

Ningbo Bros Textile Co.
1 Nan'er East Road, LuoTou Town
Zhen Hai, Ningbo
Tel: +86 0574 87142999
Fax: +86 0574 87142998
Website: www.bros.com.hk

Zhejiang Huafu Textile Co. Ltd
Tel: +86 571 86962936
E-mail: zjhuafu@mail.hz.zj.cn
Website: www.e-huafu.com

China Resources Light Industries and Textiles
(Holdings) Co. Ltd
11/F., China Resources Building
26 Harbour Road, Wanchai
Hong Kong
Tel: +852 2593 8111
Fax: +852 2827 4211
E-mail: info@crlintex.com
Website: www.crlintex.com

Sanyang Textile Co. Ltd
Liqi Rd. Lijin County, Dongying City
Shandong Province 257400
Tel: +86 546 5368188, +86 546 5368166
Fax: +86 546 5368001
E-mail: sanyang@sanyanggroup.com
Website: www.chinasanyangtex.com

Texhong Textile (Group) Co. Ltd
Seat ABC, 4th floor, Tianhong Building,
80 Xianxia Road, Changning District,
Shanghai

Tel: +86 21 62958666
Fax: +86 21 62958787
E-mail: info@texhong.com
Website: www.texhong.com

Shijiazhuang Changshan Textile Co. Ltd
183 Heping East Road
Shijiazhuang

Tel: +86 311 86213737, 86213767
Fax: +86 0311 86213752
E-mail: webmaster@changshantex.com
Website: www.changshangf.com

Shandong Demian Group Co. Ltd
18 Western Road, Shunhe, Dechen District
Dezhou City, Shandong Province 253002

Tel: +86 534 2436001
Fax: +86 534 2436666
E-mail: info@dmjt.com
Website: www.dmjt.com

Fulida Group Holding Co. Ltd
Farm 2, Xinwan, 311228 Xiaoshan
Hangzhou, Zhejiang Province 311228

Tel: +86 571 82125120
Fax: +86 571 82127258
E-mail: fld@hzfulida.com
Website: www.hzfulida.com

Jiangsu Dasheng Group Co. Ltd

Tel: +86 513 85545145
Fax: +86 513 85544238
E-mail: bwd@dasheng-group.com.cn
Website: www.hzfulida.com

Guanxing Textile (Group) Co. Ltd
221 Zhenxing Road, Guan County
Liaocheng, Shandong

Tel: +86 635 5231577
Fax: +86 635 5231577

Galaxy Textile Group Co. Ltd
Lai Wu, Shandong, China 271113

Tel: +86 634 6588618
Website: www.cotton-textile.com

Jiangsu White Rabbit Textiles Group Co. Ltd
XiuShan Road No. 677

Hai Mei Economic Development Zone
Jiangsu

Tel: +86 513 2213452
Fax: +86 513 2216275
E-mail: jsbt@public.nt.js.cn
Website: www.jsbt.com.cn

Taifeng Textile Group

59 Huiyuan Street, Kaifu
Laiwu City, Shandong 271100

Tel: +86 634 8856668
Fax: +86-634-8856616
E-mail: hqd1968@163.com
Website: www.taifeng.cc

Henan Xinye Textile Stock Co. Ltd
15 Shuyuan Road, Xinye County

Henan Province 473500

Tel: +86 377 6221552
Fax: +86 377 6221731
E-mail: maoyibu@xinye-tex.com
Website: www.xinye-tex.com

Anhui Huamao Group

80 South Fangzhi Road, Anqing City
Anhui 246018

Tel: +86 556 5919891, 5919892
Fax: +86 556 5919900
E-mail: aqfz@mail.hf.ah.cn
Website: www.chinahuamao.net

Shandong D&Y Textile & Garment Group
East Dongyue Street

Taian

Tel: +86-538 6117569, 612600, 6122007
Fax: +86-538 6115373
E-mail: zhu@daiyin.com, ylc@daiyin.com
Website: www.daiyin.com

Shandong Huale Textile Co. Ltd

West Zhaitoubao, Leling 253614

Tel: +86 534 6708889
Fax: +86 534 6708880
E-mail: sdhuale@sina.com
Website: www.hualetex.cn

Dongying Tansins Textile Co. Ltd

11 Donger Road, Dongying
Shandong 257091

Tel: +86 546 8351000, 8351403, 8352001,
8352867
Fax: +86 546 8351300, 8353555
Website: www.tansins.net

Other useful addresses

China Chamber of Commerce for Import & Export of
Textiles

12 Panjiayuan Nanli, Chaoyang District
Beijing 100021

Tel: +86 10 87789108
Fax: +86 10 67739269
E-mail: relation@ccct.org.cn
Website: www.ccct.org.cn

China Chemical Fibers Association

12 East Chang An Street,
Beijing, China 100742

Tel: +86 10 85229434, 85229438
Fax: +86 10 85229470
E-mail: mail@ccfa.com.cn
Website: www.ccfa.com.cn

China Cotton Association (CCA)

45 Fu Xing Men Nei Street,
Beijing, China 1000801

Tel: +86 10 66050406, 66052674
Fax: +86 10 66053496
E-mail: info@china-cotton.org
Website: www.china-cotton.org

China Cotton Industries Ltd
1st Floor, Tower B1, Chengming Building,
2 South Xizhimen Street, Xicheng District
Beijing 100035
Tel/Fax: +86 10 66139662
E-mail: intl@sinocot.com
Website: www.sinocot.com

China Cotton Textile Association
12 East Chang an Street
Beijing 100742
Tel: +86 10 85229479, 85229410
Fax: +86 10 85229415, 85229419
E-mail: mfxh@tceb.com
Website: www.ccta.org.cn

China National Cotton Exchange
12th Floor, Tower B, Tongtai Building
33 Finance Street
Beijing 100032
Tel: +86 10 88086754
Fax: +86 10 88086617
E-mail: sunjuan@cnce.com
Website: www.cottonchina.org

China National Cotton Reserves Corporation
17 Huayuan Street, Xicheng District
Beijing 100032
Tel: +86 10 58519365
Fax: +86 10 58519365
E-mail: cncrc@cncrc.com.cn
Website: www.cncrc.com.cn

INDIA

Top 20 cotton textile mills

The Arvind Mills Limited
Naroda Road
Ahmedabad – 380025, Gujarat
Tel: +91 79 22203030
Fax: +91 79 22201270
E-mail: gp.thapak@arvindmills.com
Website: www.arvindmills.com

Nahar Spinning Mills Ltd
Nahar Tower, 373, Industrial Area-'A'
Ludhiana-141 003, Punjab
Tel: +91 161 2600701-05, 2606977-80
Fax: +91 161 2601956, 2222942
E-mail: info.nsm@owmnahar.com,
secnsm@owmnahar.com
Website: www.owmnahar.com/nsm/

Sai Lakshmi Industries Pvt. Ltd
Kannamangala, Whitefield-Hoskote Road
Bangalore - 560 067
Tel: +91 80 2845 3746/47
Fax: +91 80 2845 3910
Website: www.sailakshmi.com

Vardhman Spining and General Mills Ltd
Chandigarh Road, Ludhiana
Tel: +91 161 2662543-47, 2602700
Fax: +91 161 2662542, 2664541
E-mail: ijdhuria@vardhman.com
Website: www.vardhman.com

Gontermann Peipers Textiles
GPI Textiles Ltd
Bharatgarh Road, Nalagarh-174101, Distt Solan
Himachal Pradesh
Tel: +91 1795 222282-86
Fax: +91 1795 222287
E-mail: gpil@gpiltexile.com
Website: www.gpiltexile.com

Ginni Filaments Limited
8th Floor, Padma Tower II, 22 Rajendra Place
New Delhi –110008
E-mail: ginni@ginnifilaments.com,
rrmaheshwari@ginnifilaments.com

Century Textiles & Industries Limited
Pandurang Budhkar Marg, Worli
Mumbai, Maharashtra – 400030
Tel: +91 22 24957000
Fax: +91 22 24304144
E-mail: centextmill@centurytext.com

The Khatau Makanji Spg & Wvg Co Ltd
Bapurao Jagtap Marg, Byculla
Mumbai, Maharashtra – 400027
Tel: +91 22 2694966, 2614504
Fax: +91 22 3073543

Mafatlal Industries Limited (New Shorrock Mills)
P.B.No.55, Kapadwanj Road Nadiad
Kheda, Gujarat – 387001
Tel: +91-268 -2550226 to 2550230
Fax: +91-268 -2565030
E-mail: milnad@rediffmail.com
xerxes@mafatlals.com
Website: www.mafatlals.com

Banswara Syntex Limited
Industrial Area, Dohad Road
Banswara, Rajasthan – 327001
Tel: +91-2962-242301 to 06
Fax: +91-2962-240692
E-mail: costbsw@banswarafabrics.com

Maharaja Shree Umaid Mills Limited
P.B. No.19, Pali-Marwar
Pali, Rajasthan – 306401
Tel: +91 2932 220286, 220292, 221287
Fax: +91 2932 221333
E-mail: palimill@satyam.net.in

Gokak Mills (Divn. of Forbes Gokak Limited)
Gokak Falls (PO)
Belgaum, Karnataka – 591308
Tel: +91-8332-25004, 25154
Fax: +91-8332-25354
E-mail: cd@gmlgkk.gokak.sprintsmx.ems.vsnl.net.in

Kesoram Textile Mills Ltd
(Kesoram Industries Ltd)
42, Garden Reach Road
Calcutta
24 Paraganas (South)
West Bengal - 700024
Tel: +91-33 -4691106/1110/7825/6788
Fax: +91-33 -4691092

STI India Limited
Rau Pithampur Link Road, Tehsil Mhow
Indore, Madhya Pradesh - 453332
Tel: +91 731 5020000
Fax: +91 731 5020011
E-mail: agmc@stitextile.net

Aditya Birla Nuvo Ltd
Rishra, PO Prabasnagar
Hooghly, West Bengal – 712249
Tel: +91 33 26721146
Fax: +91-33 26721683
E-mail: vgoenka@adityabirla.com

Hindon River Mills
Post Box No.43, Dasna Hindon Nagar
Ghaziabad, Uttar Pradesh – 201001
Tel: +91 120 2750010-13
Fax: +91 120 2750018

Rajasthan Spg & Wvg Mills Limited
Kharigram, P B No 28 Gulabpura
Bhilwara, Rajasthan - 311021
Tel: +91 2962 223144-150
Fax: +91 2962 223361
E-mail: maheshbihani@lnjb.com

Orissa Textile Mills Limited
Choudwar (AT & PO)
Cuttack, Orissa - 754025
Tel: +91-676-2692231-233
Fax: +91-676 -2692236

Narsinggirji Mills
P.B.No.23, Station Road, Solapur
Maharashtra - 413001
Tel: +91-217 -2621142
Fax: +91-217 -2621170

Maral Overseas Limited (EOU)
Maral Sarovar (Vill. & PO)
A.B.Road Nimrani, Khargone
Madhya Pradesh - 451660
Tel: +91 7285 265401-05
Fax: +91 7285 265406
E-mail: maralsarovar@injb.com

Other useful contacts

Confederation of Indian Textile Industry (CITI)
6th floor, Narain Manzil
23, Barkambha Road
New Delhi
Tel: +91 11 23325012/13/15
Fax: +91 11 51519602
E-mail: mail@citiindia.com
Website: www.citiindia.com

Cotton Association of India (EICA)
Cotton Exchange Building, 2nd floor
Opp. Cotton Green Railway Station, Cotton Green
Mumbai 400 033
Tel: +91 22 23704401/02/03, 23729438
Fax: +91 22 23700337
E-mail: eica@bom8.vsnl.net.in
Website: www.eica.in

Northern India Cotton Association Limited (NICA)
P.B. No. 79, Nai Basti
Gali No. 6, Bathinda
Punjab
Tel: +91 164 2237945, 2250352
Fax: +91 164 2252688

South India Cotton Association (SICA)
Post Box No. 3310
477, Kamarajar Road, Uppiliapalayam Post
Coimbatore 641 015
Tel: +91 422 2472331, 2473625
Fax: +91 422 2472396
E-mail: sicacoimbatore@vsnl.com,
vishwanathancbe@eth.net, narentex@vsnl.net

The Cotton Textiles Export Promotion Council
(TEXPROCIL)
Engineering Centre, 9, Mathew Road
Mumbai 400 004
Tel: +91 22 23632910
Fax: +91 22 23632914 (Fax)
E-mail: texprocil@vsnl.com
Website: www.texprocil.com

Office of Textiles Commissioner
New CGO Building, 48, New Marine Lines
Mumbai - 400020
Tel: +91 22 22001050
Fax: +91 22 22004693
E-mail: texcomindia@txcindia.com
Website: www.txcindia.com, www.txcindia.gov.in

Cotton Corporation of India (CCI)
Kapas Bhawan, Plot No. 6A
Sector - 10, Belapur
Navi Mumbai – 4000612
Tel: +91 22 22028148, 27576044
Fax: +91 22 27580934
E-mail: headoffice@cotcorp.com
Website: www.cotcorp.com

Directorate General of Foreign Trade (DGFT)
Udyog Bhawan, H-Wing

Gate No.2, Maulana Azad Road
New Delhi -110011
Tel: +91 11 23061562, +91 11 23062225
E-mail: dgft@nic.in
Website: <http://dgft.delhi.nic.in>

The South India Textile Research Association
(SITRA)
P.B.No.: 3205, Coimbatore Aerodrome Post,
Coimbatore - 641 014,
Tamil Nadu
Tel: +91 422 2574367-9
Fax: +91 422 2571896
E-mail: sitra@vsnl.com
Website: www.sitra.org.in

PAKISTAN**Useful contacts**

Ministry of Commerce
Government of Pakistan
Block 'A', Pakistan Secretariat
Islamabad
Tel: +92 51 9205708
Fax: +92 51 9205241
E-mail: mincom@commerce.gov.pk
Website: www.mincom.pk

Directorate, Trade Organization
Ministry of Commerce
Government of Pakistan
Block 'A', Pakistan Secretariat,
Islamabad
Tel: +92 51 9204326
Fax: +92 51 9209320
E-mail: haider.raza@commerce.gov.pk

Agriculture Development Commissioner
Ministry of Food, Agriculture & Livestock
Government of Pakistan
Block 'B', Pakistan Secretariat,
Islamabad
Tel: +92 519201718
Fax: +92 51 9220998
E-mail: ccw_minfal@hotmail.com
Website: www.minfal.gov.pk

Ministry of Textile Industry
Government of Pakistan
Block 'A', Pakistan Secretariat
Islamabad
Tel: +92 51 9203346, 9203349
Fax: +92 51 9203345
E-mail: secretary@textile.org.pk
Website: <http://textiles.gov.pk>

Central Board of Revenue,
Government of Pakistan
Constitution Avenue, G-5, Islamabad
Tel: +92 51 111 227 227, 111 227 228
Fax: +92 51 9207540
E-mail: helpline@cbr.gov.pk
Website: www.cbr.gov.pk

Trade Development Authority of Pakistan
(since November 2006)
Ministry of Commerce, Government of Pakistan
5th Floor, Block 'A', Sharea Faisal
Karachi
Tel: +92 21 9202719, 9206462
Fax: +92 21 9206461
E-mail: epb@epb.gov.pk
Website: <http://epb.gov.pk>

Pakistan Central Cotton Committee
Ministry of Food, Agriculture & Livestock
Government of Pakistan
47A, Hussain Centre, Darul Aman Housing Society
Main Sharea Faisal, Karachi
Tel: +92 21 4322349
Fax: +92 21 4322343
E-mail: pccc@super.net.pk

Karachi Cotton Association
Cotton Exchange Building
I.I.Chundrigar Road
Karachi
Tel: +92 21 2425007, 2412570
Fax: +92 21 2413035
E-mail: contact@kcapak.org
Website: www.kcapak.org

Pakistan Cotton Standards Institute
Ministry of Textile Industry
Government of Pakistan
26E, Block 6, PECHS, Off. Sharea Faisal
Karachi
Tel: +92 21 4324448-9
Fax: +92 21 4324446
E-mail: pcsi2002@yahoo.com

Textile Commissioners Organization
Ministry of Textile Industry
Government of Pakistan
2nd Floor, Kandiwala Building, M.A.Jinnah Road
Karachi
Tel: +92 21 9215083
Fax: +92 21 9215014
E-mail: tco_govpk@yahoo.com
Website: www.tco.gov.pk

All Pakistan Textile Mills Association
House No. 44-A
Lalazar, Off. Maulvi Tamizuddin Khan Road
Karachi
Tel: +92 21 111 700 000
Fax: +92 21 5611305
E-mail: aptma@cyber.net.pk
Website: www.aptma.org.pk

Trading Corporation of Pakistan
Ministry of Commerce
Government of Pakistan
4th & 5th Floor, Block-B, FTC Building
Sharea Faisal
Karachi
Tel: +92 21 9202596
Fax: +92 21 9202722
E-mail: tcpotton@cyber.net.pk
Website: www.tcp.gov.com.pk

Top 18 cotton-importing textile mills producing yarn counts 50s to 100s

Al Karam Textile Mills (Pvt) Ltd
3rd Floor, Karachi Dock Labour Board Building
58 West Wharf Road
Karachi
Tel: +92 21 2313031-35
Fax: +92 21 2310625
E-mail: headoffice@alkaram.com
Website: www.alkaram.com

Ayesha Textile Mills Ltd
97 Bales Gulberg 2
Lahore
Tel: +92 42 5756707, 5756710
Fax: +92 42 5712151
E-mail: ayeshatex@brain.net.pk
Website: www.ayeshagroup.com

Crescent Textile Mills Ltd
40A Off. Zafar Ali Road
Lahore
Tel: +92 42 111 245 245
Fax: +92-42 111 222 245
E-mail: crestex2ctm.com.pk
Website: www.crescenttextile.com

Dewan Textile Mills Ltd
Dewan Centre, 3A Lalazar
Beach Luxury Hotel Road
Karachi
Tel: +92 21 111 313 786
Fax: +92 21 5610245
E-mail: gmk1n@dewangroup.com.pk
Website: <http://dewangroup.com.pk>

Ejaz Spinning Mills Ltd
301–307, 3rd Floor, Business Centre
Dunolly Road, Off I.I. Chundrigar Road
Karachi
Tel: +92 42 111 699 699
Fax: +92 42 5712563
E-mail: akhattuk@ejazgroup.com.pk
Website: www.ejazgroup.com

Fazal Textile Mills Ltd
L–A–2/B, Block 21, F.B. Area
Karachi
Tel: +92 21 6322048
Fax: +92-21 6313372
E-mail: export@fazaltextile.com
Website: <http://fazaltextile.com>

Gadoon Textile Mills Ltd
All Pakistan Textile Mills Association
House Tehkal Payan, Jammrud Road
Peshawar
Tel: +92 91 5701496
Fax: +92 91 840273
E-mail: gadoon@cyber.net.pk
Website: www.gadoon.com

Gul Ahmed Textile Mills Ltd
Plot No. 82, Main National Highway, Landhi
Karachi
Tel: +92 21 111 485 485, 111 486 486
Fax: +92 21 5019802, 5080071
E-mail: gulahmed@gulahmed.com
Website: www.gulahmed.com

Gulistan Spinning Mills Ltd
2nd Floor, Finlay House
I.I. Chudrigar Road
Karachi
Tel: +92 21 111 200 000
Fax: +92 21 2411559
E-mail: khi@gulistangroup.com.pk
Website: www.gulistangroup.com.pk

Gulistan Textile Mills Ltd
2nd floor, Finlay House
I.I. Chundrigar Road
Karachi
Tel: +92 21 111 200 000, 2419943
Fax: +92 21 2411559
E-mail: khi@gulistangroup.com.pk
Website: www.gulistangroup.com.pk

Lahore Textile & General Mills Ltd
Monnoo House, 3 Montgomery Road
Lahore
Tel: +92 42 6283637, 6278853
Fax: +92-42 6278853, 6364431
E-mail: itgm2@monnoogroup.com
Website: www.monnoogroup.com

Masood Spinning Mills Ltd
Mehar Manzil, Lahori Gate
Multan
Tel: +92 61 111 181 181
Fax: +92 61 4511262, 4549711
E-mail: infomasoodgroup.com
Website: www.masoodtextile.com

Kohinoor Spinning Mills Ltd
Kashana-e-Yusuf, Khwaja Street
Chakwal
Tel: +92 543 541950, 0303 7779786
Fax: +92 543 541850
E-mail: ksml@chakwalgroup.com.pk

Pak Kuwait Textiles Ltd
29 Shadman II
Lahore
Tel: +92 42 111 888 600
Fax: +92 42 7575531
E-mail: pctl@pakkuwait.com
Website: www.pakkuwait.com

Riaz Textile Mills (Pvt) Ltd
House No. 26, Street No. 4, F/6–3
Islamabad
Tel: +92 51 2823198, 2824768
Fax: +92 51 2828267
E-mail: mdriaz@riaztextile.com
Website: www.riaztextile.com

Sapphire Textile Mills Ltd
212 Cotton Exchange Building
I.I. Chundrigar Road
Karachi
Tel: +92 21 111 000 100
Fax: +92 21 2417418, 2416705
E-mail: info@sapphire.com.pk
Website: www.sapphire.com.pk

Saif Textile Mills Ltd
All Pakistan Textile Mills Association House
Tehkal Payan, Jammrud Road
Peshawar
Tel: +92 91 843870, 5702941
Fax: +92 91 840273
E-mail: stm2saifgroup.com
Website: www.saiftextile.com

Suraj Cotton Mills Ltd
7–B–3, Marina Homes
Aziz Avenue, Gulberg-5
Lahore
Tel: +92 42 5760381, 5711138
Fax: +92 42 5760376
E-mail: suraj@cyber.net.pk
Website: www.suraj.com

THAILAND**Top 15 cotton textile mills**

Bangkok Weaving Mills Ltd
879 Bangkok-Nonthaburi Rd., Bangsue
Bangkok 10800
Tel: +662 5860901 10
Fax: +662 5872338, +662 5860915
E-mail: bwm@thai.com
Mr. Phongsak Assakul, Managing Director

Chiem Patana Knitting Co., Ltd
23/3 Moo3 Petchkasem Km33 Rd.
Yaicha, Sam Phran
Nakhon Pathom 73110
Tel: +6634 311273 4
Fax: +6634 322559
E-mail: export1@chiempatana.com
Mr. Jitikon Chiempitayanuvat, Managing Director

Chum Sang Textile Co., Ltd
1/144 Moo2 Rama 2 Rd., Thasai, Mueang
Samut Sakhon 74000
Tel: +6634 490029
Fax: +6634 490030
E-mail: mighty777@hotmail.com
Mr. Chatri Temtanarak, Managing Director

K. Cotton & Gauze Co., Ltd
3 FL Siphya Construction Bldg
95 Sua Pa Rd., Pom Prap Sattru Phai
Bangkok 10100
Tel: +662 2250060
Fax: +662 2240716
E-mail: k cotton@mozart.inet.co.th
Mr. Tayuth Sriyuksiri, Managing Director

Kangwal Textile Co., Ltd
1426/18-20 Krung Kasem Rd., Pom Prap Sattru Phai
Bangkok 10100
Tel: +662 2263930
Fax: +662 226 3045
E-mail: sales@kangwal.co.th
Mr. Niphan Wongphanlert, Managing Director

Kongkiat Textile Co., Ltd
259/1 Moo6 Soi Ratburana 44, Rat Burana
Bangkok 10140
Tel: +662 463 0020 1
Fax: +662 4631914
E-mail: sales@kongkiat.com
Mr. Dumrong Kongkiakrai, Managing Director

Luckytex (Thailand) Public Co., Ltd
(Mill No. 1)
38 Moo14 Suksawad Rd., Phra Pradaeng
Samut Prakan 10130
Tel: +662 462 6310 2
Fax: +662 463 1968
E-mail: luckytex_mill1ptcc@toray.co.th
Mr. Warun Laoitthi, Mill Manager

Mandarin Spinning Industry Co., Ltd
17/2 Soi Wat Phothongbol, Tivanon Rd., Pak Kret
Nonthaburi 11120
Tel: +662 583 9361

Fax: +662 583 9037
E-mail: mandarin@anet.net.th
Mr. Somsong Wongsirikul, President

Nan Yang Textile Co., Ltd
77 Nan Yang Textile Bldg. Moo2
Petchkasem 71 Rd., Nong Khaem
Bangkok 10160
Tel: +662 421 2150
Fax: +662 421 2699
E-mail: chotik.c@nanyangtextile.com
Mr. Chotik Chavapokin, Division Director

Phipatanakit Textile Co., Ltd
222 Moo8 Bhutharaksa Rd., Taiban, Mueang
Samut Prakan 10280
Tel: +662 3871465 7
Fax: +662 3872411
E-mail: ptc@loxinfo.co.th
Mr. Veerachai Pinyawat, Managing Director

Rama Textile Industry (1998) Co., Ltd
525 Moo2 Petchkasem Km 35 Rd., Bangpoo Mai,
Mueang
Samut Prakan 10280
Tel: +662 3230663 4
Fax: +662 3230611
E-mail: thaitex3@ksc.th.com
Mr. Pairod Chuenchoojit, Managing Director

S.R. Spinning Co., Ltd
729/77-78 Rajadapisek Rd., Bangpongpan, Yanawa
Bangkok 10120
Tel: +662 6838723 26
Fax: +662 6838721
E-mail: info@sr spinning.com
Mr. Thavesak Buranatrakul, Managing Director

Thai Textile Industry Plc.
385 Soi Bang Maek Khao, Sukhumvit Km. 30.5 Rd.
Samut Prakarn 10280
Tel: +662 7038484, +662 3871980
Fax: +662 3870894, +662 3871983
E-mail: thaitex@tti.co.th
Mr. Tawatchai Chaiyapinunt, Executive Director

Union Textile Industries Public Co., Ltd
1828 Sukhumvit Rd., Bangchak, Phra Khanong
Bangkok 10250
Tel: +662 3115111
Fax: +662 3323123
E-mail: manas_su@inet.co.th
Mr. Vacharaphong Darakananda, Director

Vichien Textile Industry Co., Ltd
191 Moo8 Suksawasdi Rd., Bangkhru
Phra Pradaeng
Samut Prakan 10130
Tel: +662 4643348 52
Fax: +662 4643354
E-mail: vichien@vichien_group.com
Mr. Prayyud Ruenrudeepanya, Director

Useful contacts

Ministry of Commerce
44/100 Nonthaburi 1 Rd., Amphur Muang
Nonthaburi 11000
Tel: +6602 507 8000
Fax: +662 507 7717
Website: www.moc.go.th

Department of Export Promotion
22/77 Rachadapisek R., Chatuchak
Bangkok 10900
Tel: +662 513 1909 to 15
Fax: +662 513 1565,2512
E-mail: itict@depthai.go.th
Website: www.depthai.go.th

Department of Industrial Promotion
Rama 6 Rd., Rachathewee, Bangkok 10400
Tel: +662 202 4414 18
Fax: +662 246 0031
E-mail: webmaster@dip.co.th
Website: www.dip.go.th

Ministry of Agriculture and Cooperatives
3 Radchadamneng, Pantom, Pranakorn
Bangkok 10200
Tel: +662 281 5955
Fax: +662 281 5884
E-mail: webmaster@moac.go.th
Website: www.moac.go.th

Office of Agricultural Economics
Kasetsart University Complex Jatujak
Bangkok 10900
Tel: +662 940 5550 1
Fax: +662 940 5556 9
Website: www.oae.go.th

Ministry of Industry
Rama 6 Rd., Rachathewee
Bangkok 10400
Tel: +662 202 3000
Fax: +662 202 3048
E-mail: eneral_ops@mindustry.go.th
Website: www.m-industry.go.th

Thai Customs Department
1 Sunthornkosa Rd., Khlongtoey
Bangkok 10110
Tel: +662 249 0431 40
Fax: +662 249 0431 40
Website: www.customs.go.th

Thailand Textile Institute (THTI)
Soi Trimit Rama 4 Rd., Phrakanoeng, Klong-toey
Bangkok
Tel: +662 713 5492-9
Fax: +662 712 1592-3
E-mail: info@thaitextile.org
Website: www.thaitextile.org

Thai Textile Manufacturing Association (TTMA)
454-460 Sukhumvit Rd. (22), Klongton, Klongtoey
Bangkok 10110
Tel: +662 258 2023
Fax: +662 421 2699
E-mail: ttma@thaitextile.org
Website: www.thaitextile.org/ttma

TURKEY**Cotton trading/representation companies**

Ari Tarım Ürünleri Pazarlama
Tic.Sanayi A.Ş.
Atatürk Cad.Tic. Borsası Yani
Pamuk Apt. Kat:3 Adana
Tel: +90 90 322 4541624, 4582954
Fax: +90 322 4535286, 4583789
E-mail: aritarim@aritarim.com.tr
Website: www.aritarim.com.tr

İmisk İthalat İhracat Ticaret
Ve Nakliyat A.Ş.
Uray Cad.Sezer İşhane Kat:2
No:20-21 33010 Mersin
Tel: +90 324 2383060
Fax: +90 324 2311529, 2383070
E-mail: sahap@imisk.com.tr
Website: www.imisk.com.tr

Levend Pamuk Dış Ticaret A.Ş.
Atatürk Cad.14 Sokak Güven Apt
Kat:4 No:7 Seyhan Adana
Tel: +90 322 4595669
Fax: +90 322 4573146
E-mail: info@levendpamuk.com.tr

Pamteks Pamuk Ve Tekstil Ürün.
İhracat Ve İthalat A.Ş.
Atatürk Cad. Güven Apt. No 11
Kat:6 1120 Adana
Tel: +90 322 4530456, 4539838
Fax: +90 322 4585794
E-mail: pamteks@superonline.com

Ptm Pamuk Ve Toprak Mahsul. İhr.Ve İthalat A.Ş.
Atatürk Cad.Ticaret Borsası
Kat:6 No:55 Pk:106 Adana
Tel: +90 322 4585273
Fax: +90 322 4572075
E-mail: ptm@ptm.com.tr
Website: www.ptm.com.tr

S.S.Çukurova Pamuk T.S.K.B
(Only In Exporting)
Mersin Yolu 19.Km. P.K.:3
1321 Adana
Tel: +90 322 4410121
Fax: +90 322 4410713
Website: www.cukobirlik.com.tr

Aklo Tarım Ürün Değ. İth. İhr. Ve Tic. A.Ş
Şehit Fethi Bey Cad. No:49/8
35210 İzmir
Tel: +90 232 4836790
Fax: +90 232 4257964
E-mail: info@aklo.com

Egedeniz Tekstil San. Ve Tic. A.Ş
İşçiler Caddesi No.176/2
Alsancak 35230 İzmir
Tel: +90 232 4637094
Fax: +90 232 4639021
E-mail: info@egedeniztextile.com

Kadioglu Tarım Ticaret Ve San. A.Ş
İşçiler Caddesi No.176
35230 İzmir
Tel: +90 232 4213680
Fax: +90 232 4222549
E-mail: aydin.unsal@veezy.com

Öztaş Tarım Tic. Ve End. A.Ş
Atatürk Cad. No:378/1 Kat 3
Alsancak 35220 İzmir
Tel: +90 232 4221080
Fax: +90 232 4220638
E-mail: mehmet@etemozsoy.com

Pagysa Pamuk Gıda Yerli Ürünler. Tic. Ve Sanayi A.Ş
Kazım Dirik Mah.364 Sokak No:
21/A, Bornova 35100 İzmir
Tel: +90 232 4612039
Fax: +90 232 4611283
E-mail: info@pagysa.com
Website: www.pagysa.com

S.S.Tariş Pamuk T.S.K.B
(Only In Exporting)
1492 Sok. No 14
Alsancak 35230 İzmir
Tel: +90 232 4635500
Fax: +90 232 4210066
E-mail: taris@taris.com.tr
Website: www.taris.com.tr

Cotton brokers/commission agents (at the Izmir Mercantile Exchange, IME)

Emin DINLETEN, Cotton Broker, Şehit
Fethi Bey Cad., No 32/2 Çankaya
35210 İzmir
Tel: +90 232 4844083

Aydin KESEN, Cotton Broker
1347 Sokak No:1, Kat 5, Çankaya
35210 İzmir
Tel: +90 232 4845197

Umur Simsaroğlu, Cotton Broker
Gazi Bulvarı No:2, Gümrük
35210 İzmir
Tel: +90 232 4251370

Useful addresses

Ministry of Foreign Affairs
Ankara
Tel: +90 312 2872555
Fax: +90 312 2871886
Website: www.mfa.gov.tr

Ministry of Agriculture and Rural Affairs
Ankara
Tel: +90 312 4178400
Fax: +90 312 4170026
Website: www.tarim.gov.tr

Ministry of Industry and Commerce
Ankara
Tel: +90 312 2317280
Fax: +90 312 2874349, 2308704
Website: www.sanayi.gov.tr

Ministry of Transportation
Ankara
Tel: +90 312 2126730
Fax: +90 312 2124900
Website: www.ubak.gov.tr

Undersecretariat of Customs
Hükümet Meydanı, Ulus
06100 Ankara
Website: www.gumruk.gov.tr

Undersecretariat of Foreign Trade
Ankara-Eskisehir Karayolu, Inonu
Bulvarı Emek Mevkii
Ankara
Tel: +90 312 2128800
Fax: +90 312 2121622
Internet: www.foreigntrade.gov.tr

Undersecretariat of Foreign Trade
Directorate General of Free Zones
06510 Emek, Ankara
Tel: +90 312 2125887, 2128906, 2128258
Fax: +90 312 2128906
Website: www.dtm.gov.tr/sb/english/legislation.htm

Undersecretariat of Treasury
Ankara-Eskisehir Karayolu Inonu Bulvarı
Emek Mevkii
Ankara
Tel: +90 312 2128800
Fax: +90 312 2128783, 2128778
Website: www.treasury.gov.tr

Export Promotion Centre of Turkey
İhracatı Gelistirme Merkezi (İGEME)
Mithatpaşa Caddesi, No:60, 06420 Ankara
Tel: +90 312 4172223
Fax: +90 312 4172233
Website: www.igeme.org.tr

The Central Bank of the Republic of Turkey (TCMB)
Istiklal Cad. No:10, 06100 Ulus
Ankara
Tel: +90 312 3103646
Fax: +90 312 3107434
E-mail: info@tcmb.gov.tr
Website: www.tcmb.gov.tr

Turkish Eximbank
Milli Mudafaa Cad. No:20, 06100 Bakanliklar
Ankara
Tel: +90 312 4171300
Fax: +90 312 4257896
E-mail: info-t.tanyil@eximbank.gov.tr
Website: www.eximbank.gov.tr

State Institute of Statistics (S.I.S)
Necatibey Cad. No:114, Bakanliklar
Ankara
Tel: +90 312 4176440
Fax: +90 312 4170432
Website: www.die.gov.tr

State Planning Organization (S.P.O)
Necatibey Cad. No:110, Ankara
Tel: +90 312 2308720
Fax: +90 312 2309733, 2313498
Website: www.dpt.gov.tr

Exporters unions (dealing with exports of cotton, textiles, garments, etc.)

General Secretariat of Aegean Exporters Union
Atatürk Cad. No:382, Alsancak 35220
Izmir
Tel: +90 232 4886000
Fax: +90 232 4886100
E-mail: eib@egebirlilik.org.tr
Website: www.egebirlilik.org.tr

General Secretariat of Denizli Textile and Clothing Exporters Union
Halk Cad.Furkan Is Merkezi No:28
20100 Denizli
Tel: +90 258 2633992
Fax: +90 258 2420989, 2621433
E-mail: detkib@detkib.org.tr
Website: www.detkib.org.tr

General Secretariat of Istanbul Textile & Apparel Exporters Union (Itkib)
Cobancesme Mevkii, Sanayi Caddesi
Dis Ticaret Kompleksi - A Blok, Yenibosna, 34530
Bahcelievler / Istanbul
Tel: +90 212 4540200
Fax: +90 212 4540201
E-mail: info@itkib.org.tr
Website: www.itkib.org.tr

General Secretariat of Mediterranean Exporters Union
Uray Cad. Turan Ishani Kat:3-4
33001 Mersin
Tel: +90 324 2315710
Fax: +90 324 2323325, 2326218
E-mail: arge@akib.org.tr
Website: www.akib.org.tr

General Secretariat of South Eastern Anatolia Exporters Union
Inonu Cad. Keles Hoca Sok. No:1 Kat:1
27200 Gaziantep
Tel: +90 342 2200010
Fax: +90 342 2200015
E-mail: gaibbim@future.net.tr
Website: www.gaib.org.tr

General Secretariat of Uludag Exporters Union
Organize San. Böl. Kahverengi Cad., No:8 Nilüfer
16159 Bursa
Tel: +90 224 2191000, 4440616
Fax: +90 224 2191090, 2191096
E-mail: arge@uib.org.tr, uludag@uib.org.tr
Website: www.uib.org.tr

Mersin Free Zone Directorate Free Zones
(Mainly for Cotton, Textiles, etc.)
P.K. 15 Mersin
Tel: +90 324 2387590, 2387595
Fax: +90 324 2387598
E-mail: info@mersinsbm.com

Aegean Free Zone Directorate
Akçay Cad. No:144/1 Gaziemir/Izmir
Tel: +90 232 2510244, 2515454
Fax: +90 232 251 16 62
E-mail: egesbm@superonline.com

Denizli Free Zone Directorate
20350 Çardak/Denizli
Tel: +90 258 8511119, 8511016
Fax: +90 258 8511038
E-mail: denizlisbm@ttnet.net.tr

Appendix I

International cotton associations

Participants in international trade in many countries are organized into national cotton associations, many with an international character. The membership of some associations includes both domestic and foreign organizations and individuals. Cotton associations serve the interests of cotton producers, buyers, sellers and consumers by providing trading rules and mechanisms to resolve trade disputes and by serving as arbitration authorities. Cotton associations promote and facilitate cotton trade in a fair and orderly fashion for the benefit of a sound world cotton economy. In addition to maintaining trading rules, cotton associations provide other important services, such as technical and quality arbitration, traditional and HVI classing, forums for international conferences and discussions of cotton affairs, training seminars around the world, market information and statistics.

Committee for International Co-operation between Cotton Associations (CICCA) (www.cicca.info)

Seventeen of the largest cotton associations with similar objectives comprise the Committee for International Co-operation between Cotton Associations, which was established in 1976. Each of the CICCA member associations acts independently, but uses CICCA as a forum for discussion and collective action when appropriate. CICCA promotes trading rules and arbitration practices of its member associations and stands for the concept of sanctity of contracts and good trading practices. CICCA objectives include assistance in ensuring that dispute resolution procedures are adhered to and any consequential awards upheld. CICCA circulates to member organizations a consolidated list of firms reported to have failed to properly comply with valid arbitration awards made by member-organizations. It also publishes a directory of all firms affiliated with its member associations. Membership in the 17 CICCA member associations accounts for more than 1,000 firms associated with the cotton industry. Members of these associations handle the bulk of world cotton trade.

Africa: Association Cotonnière Africaine – African Cotton Association (ACA) (www.africancotton.org)

The Association Cotonnière Africaine – African Cotton Association was founded in 2002 and is headquartered in Cotonou, Benin. It has 25 active members involved in cotton ginning and marketing from 14 African countries, 6 associate members (producer associations, textile companies, oil crushing companies), and 41 corresponding members (transport companies, forwarding agents, banks, insurance companies, cotton merchants, foreign cotton associations). The Association was founded out of concern shared by many of the producing countries about government policies in some of the major producing countries subsidizing cotton production and leading to market distortions. The Association serves as a forum for experience-sharing between African cotton companies, and works with other international associations on upholding fair cotton trading rules and the sanctity of contracts. Informational and educational work plays an important part in the association's activity.

Australia: Australian Cotton Shippers Association
(www.austcottonshippers.com.au)

The Australian Cotton Shippers Association was established in 1984. It comprises the 12 major merchants in Australia. The association trading rules serve to achieve the major objectives of the association, including preserving the sanctity of contracts, the integrity of the Australian trading industry, and facilitating compliance with contractual obligations and adherence to arbitration awards. The association promotes the interests of its members in overseas markets.

Belgium: Association cotonnière de Belgique (Belgian Cotton Association)

The Belgian Cotton Association is composed of about forty Belgium-based merchants, brokers, spinners and controllers, and foreign firms registered as associate members. Major functions of the association include maintenance of trading rules and arbitration. The association has an Executive Committee of the Chamber of Arbitration, which issues value differences for cotton of different origins. Twelve arbitrators serve in quality and commercial arbitrations and appeals. The annual report of the association includes data on Belgian and international cotton markets. International cotton merchants and representatives from Belgium and abroad attend the annual dinner of the Belgian Cotton Association.

Brazil: Bolsa de Mercadorias & Futuros, São Paulo (www.bmf.com.br)

The Bolsa de Mercadorias & Futuros (BM&F) in São Paulo, Brazil, was founded in 1917. It is an exchange where gold, currencies, and a number of agricultural commodities, including cotton, are traded in futures and cash markets. The exchange includes the elements of an association of cotton traders and as such is a member of CICC. BM&F plays an important role in regulating domestic trade, exports and imports of cotton in Brazil. It provides classification services and establishes standards for Brazilian cotton. BM&F settles disputes between traders and provides arbitration. A special committee at the exchange fixes value differences for different grades in relation to cotton type 6. A substantial portion of all contracts traded in Brazil are made subject to the rules of BM&F and are registered with the exchange. The exchange collects and publishes statistics related to cotton and is active internationally in promoting the sanctity of contracts and fair trading practices.

China: China Cotton Association (CCA), Beijing (www.china-cotton.org)

The China Cotton Association was established by cotton farmers, cotton farmers cooperative organizations, enterprises engaged in cotton production, purchase, processing, cotton textile enterprises, cotton research institutes and other organs. It is a non-profit organization under the supervision of the Ministry of Civil Affairs and receives the professional guidance of the All-China Federation of Supply and Marketing Cooperatives. CCA aims at protecting the fundamental interests of its members and the cotton industry and at making contributions to the sound development of the Chinese cotton industry. The main functions of CCA are to provide services to its members including information and statistics, to organize personal training, technical exchanges and international cooperation, and to formulate and supervise the implementation of the rules, regulations and standards of the cotton sector.

Egypt: Alexandria Cotton Exporters Association (www.alcotexa.org)

Cotton traders founded the Alexandria Cotton Exporters Association (ALCOTEXA) in 1932. As a non-profit and non-trading organization, ALCOTEXA deals only with issues related to Egyptian cotton. Non-members of ALCOTEXA are not allowed to trade cotton in Egypt. Membership in ALCOTEXA includes cotton trading and ginning companies. All exports of cotton from Egypt are subject to the terms of the Egyptian Contract. The association has a board, management committee, expert cotton classers and government sworn experts on the arbitration and appeal boards. All export sales from Egypt are based on Egyptian Testing House Terms, and arbitration is provided in Alexandria. Major functions of ALCOTEXA as a regulative authority include

formulating export policy and setting sales prices (indicative or minimum). The association revises export prices weekly, and conducts contract registrations. Twice a year ALCOTEXA publishes The Egyptian Cotton Gazette, which contains a variety of statistics on Egyptian cotton, and articles and data on trade, policy and technical issues.

France: Association française cotonnière (AFCOT), Le Havre (www.afcot.org)

The Association française cotonnière (AFCOT) is more than 100 years old and has about 80 members, including firms based in France and other countries. Membership includes cotton merchants, agents, shippers, controllers, transport organizations, ports, banks and spinners. AFCOT is ruled by a board of directors composed of members, usually merchants and controllers. AFCOT has several committees, including the Advisory Committee for Arbitration and Supervision of the Types, and the Committee on Value Differences. AFCOT publishes Le Havre General Rules, which regulate contracts for the sale of cotton and arbitration. According to a 2003 estimate, up to 100,000 tons of cotton are traded annually in Europe under AFCOT Rules. AFCOT has a laboratory which is equipped for fibre testing. The association issues a news bulletin to its members with trade statistics and other cotton-related data. The annual dinner of AFCOT is attended by hundreds of cotton representatives from France and abroad.

Germany: Bremer Baumwollbörse – Bremen Cotton Exchange (www.baumwollboerse.de)

The Bremen Cotton Exchange was founded in 1872 and represents more than 200 merchants and users of cotton. It provides international trading rules, technical and quality arbitration, traditional and HVI classing. The exchange conducts fibre testing, and research and expert surveys. Trading rules of the exchange regulate trade in raw cotton, linters, cotton and artificial fibre wastes, and provide a basis for quality and technical arbitration and an effective means for the settlement of disputes. The exchange organizes two-yearly International Cotton Conferences dealing mostly with technical issues and seminars where participants receive training in cotton classing and other technical subjects. The Bremen Cotton Exchange provides statistics and information on the domestic and international cotton market, technical issues, value differences, freight and insurance. The Bremen Fiber Institute (Faserinstitut Bremen) was founded in 1969 to serve as laboratory for the exchange. The institute's research is focused on cotton fibre properties for processing.

India: Cotton Association of India, Mumbai (www.eica.in)

The East India Cotton Association (EICA), now known as the Cotton Association of India, was established in 1921 and has about 400 members including buyers, sellers, brokers, exporters, importers and other participants in the cotton market. EICA bylaws provide trading rules for spot and forward sales of cotton. EICA is managed by the Board of Directors through various subcommittees. There are 18 regional associations and 10 marketing societies registered under it. The Rules of EICA provide mechanisms for arbitration and settlement of disputes. EICA has a panel of sworn surveyors, an umpire and a provision for appeal. One of the major functions of the association is to prepare and maintain grade and staple standards of all varieties grown in India. The association has a laboratory for fibre quality evaluation and conducts HVI cotton fibre testing. The Daily Rates Committee fixes and releases daily prices for various descriptions and staples and grades. EICA publishes other market data in its weekly bulletin. The bulk of cotton traded in India is regulated by the rules of the EICA Non-Transferable Specific Delivery Contract.

Italy: Federazione Imprese Tessili e Moda Italiane (SMI-ATI), Milan (www.smi-ati.it)

The Federazione Imprese Tessili e Moda Italiane (SMI-ATI), formed from the merger of Sistema Moda Italia (SMI) and the Associazione Tessile Italiana (ATI), came into being on 1 October 2005. The federation has about 2,000 members representing all the textile-fashion chain, from yarn to clothing. The federation safeguards and promotes the interests of its members and represents the textile and clothing industry on issues related to international trade, trade duties and quotas, currency and customs regulations. It provides training and consulting services to its

members and is a major source of economic and statistical data through a variety of publications. SMI-ATI maintains contacts and negotiates with Italian government authorities and trade unions in the industry. Substantial efforts are devoted by the federation to the promotion of cotton textile products at fashion shows.

ATI dates back to 1883 and had close to 300 member firms operating in raw cotton marketing, cotton and linen spinning, weaving and finishing. The Raw Cotton Arbitration Chamber operates within the association and serves to resolve disputes arising from cotton contracts based on the trading rules. The association has a technical laboratory equipped with modern instruments used for cotton fibre tests and research.

Japan: Japan Cotton Traders Association (JCTA), Osaka

The Japan Cotton Traders Association was founded during the 1950s. It is composed of about 80 Japanese cotton importers, domestic raw cotton traders and firms engaged in related businesses, such as shipping agents, transportation and warehousing, banks and insurance. Members of the association handle the bulk of cotton imports in Japan and imports by Japanese-owned spinning mills in other Asian countries. The major objective of the association is to strive for the sound development of cotton imports and domestic trade, trying to improve the basic terms and conditions for trade. The association is entitled to settle any claim or dispute that may arise in connection with the import and domestic trade of cotton. JCTA makes recommendations to the Government and its agencies, and cooperates with other international associations and organizations on issues related to cotton trade. JCTA conducts research and collects statistics related to cotton and issues a number of publications, including a statistical yearbook.

Pakistan: The Karachi Cotton Association (KCA) (www.kcapk.org)

The Karachi Cotton Association was established in 1933 to regulate and facilitate domestic and export trade in cotton. It has about 250 members, including cotton growers, ginners, textile mills, exporters, commission houses and others. KCA is ruled by a 21-member board of directors, of which 17 are elected annually from the membership of KCA and 4 are nominated by the Government, representing the Ministries of Agriculture, Commerce, Finance and Industry. The Rates Committee of KCA, appointed by the board, establishes daily spot rates based on cotton transactions throughout the country. KCA Bylaws and Rules regulate cotton trade and provide arbitration of disputes between parties. KCA provides traders with contract forms and adopts standards for cotton. The Association issues a daily cotton market report, containing information on spot prices and other statistics related to cotton. KCA advises the Government on various aspects of cotton policy and maintains liaison with ginners and textile mills. The association founded the KCA Institute of Cotton Grading and Classing, which provides training to representatives of the cotton industry.

Poland: Izba Bawelny W Gdyni – Gdynia Cotton Association (GCA) (www.cotton.org.pl)

The Gdynia Cotton Association (GCA) was founded in 1935 and is composed of over 100 member companies from 15 countries. Membership of GCA includes cotton textile mills, cotton merchants and research institutions. GCA bylaws and rules are used as the basis for international cotton contracts and stipulate in detail cotton arbitration and testing procedures. The major objectives of the Gdynia Cotton Association include settlement of quality and technical disputes arising from cotton trade by the Court of Arbitration of GCA, laboratory quality testing and representation of members' interests before government authorities and international organizations. GCA provides cotton classification courses for cotton classers in Polish, English and Russian languages and publishes value differences tables and a directory of member firms. It organizes international discussions at the two-yearly International Cotton Conferences in Gdynia. The association collects statistics on cotton imports and consumption in Poland.

Spain: Centro Algodonero Nacional (CAN), Barcelona (www.centroalgodonero.com)

The Centro Algodonero Nacional was founded in 1903. It represents all the sectors related to the marketing of raw cotton and its subproducts. The major objectives of CAN are to create fair trading conditions and to promote the sanctity of contracts. The rules of CAN are internationally known and recognized as the Barcelona Contract. CAN has the capacity for quality arbitration and appeals. It has a laboratory, which can perform fibre testing. Membership of CAN includes more than 100 individual members, cotton firms and associate members. Member firms and about 30 individual members operate as cotton merchants, agents or brokers. It is estimated that most cotton sales in Spain are made subject to Barcelona rules. CAN provides a variety of services to its members, and disseminates cotton information and statistics.

Turkey: Izmir Ticaret Borsasi – Izmir Mercantile Exchange (www.itb.org.tr)

The Izmir Mercantile Exchange in Turkey was founded in 1881. Like BM&F in São Paulo, the Izmir exchange functions as a trading platform for spot sales of cotton and as an association of cotton traders. The exchange serves as a price discovery instrument for spot sales of cotton and has been engaged in designing a cotton futures contract for potential introduction on the exchange-trading floor. The exchange maintains trading rules, and provides information and statistics.

United Kingdom: The International Cotton Association Limited (ICA), Liverpool (www.ica-ltd.org)

The origins of the International Cotton Association date back to 1841 when cotton brokers in Liverpool formed an association and drew up a set of trading rules. In 1882, merchants joined brokers and formed a new association named the Liverpool Cotton Association. To reflect the membership base and the mature of the association's business activities, the association was renamed the International Cotton Association on 9 December 2004. The membership of ICA includes buyers and sellers of cotton, international merchants, government marketing organizations, spinners, banks, cotton controllers and others involved in the cotton business.

ICA Bylaws and Rules are widely accepted and cover all aspects of international trade. Membership in ICA is in excess of 300 registered firms in over 60 countries worldwide. It is estimated that over 60% of the world's cotton trade is bought and sold under ICA Bylaws and Rules. ICA provides a well-established two-tier arbitration system for both quality and technical (non-quality) disputes. Contracts written under ICA Rules are subject to the laws of England, but arbitration awards can be legally enforced in most cotton trading countries. If a firm refuses to abide by arbitration or appeals a decision, that firm is included on a default list, which is distributed worldwide. The ICA provides training on international trade in cotton at an annual marketing seminar in Liverpool and seminars in other countries. The ICA annual dinner is one of the major world cotton events and is usually attended by hundreds of members and guests of the Association.

United States: American Cotton Shippers Association (ACSA), Memphis, Tennessee (www.acsa-cotton.org)

Established in 1924, the American Cotton Shippers Association is the national trade association in the United States of cotton merchants, cotton shippers and exporters of raw cotton, primary buyers, mill service agents, and of firms allied with these services. Its membership comprises four federated associations: Atlantic Cotton Association; Southern Cotton Association; Texas Cotton Association; and Western Cotton Shippers Association. ACSA has about 150 member firms, which handle an estimated 80% of the cotton sold to domestic mills in the United States and overseas. The association takes an active part in promoting the increased use of United States cotton in the United States and throughout the world, establishing with other cotton trade organizations national and international standards for trade, collaboration with producer organizations throughout the cotton belt in formulation farm programmes and cooperating with government agencies in the administration of such programmes. The ACSA International Cotton Institute is an eight-week residential programme designed to provide a basic education in all aspects of the cotton industry.

Appendix II

Conversion factors

Conversion factors			
	Weight		
	Kilograms	Pounds	480 lb bales
Ton (metric)	1,000	2,204.6	4.593
Pound	0.4536	1	480
Kilogram	1	2.2046	0.004593
Arroba (Brazil)	15	33.069	0.0689
Candy (India)	355.62	784	1.6333
Cantar, metric (Egypt)	50	110.23	0.2296
Cantar (Sudan)	44.93	99.05	0.20635
Centner (Soviet Union)	100	220.46	0.4593
Dan (China)	50	110.23	0.2296
Quintal (Argentina)	45.95	101.3	0.211
Quintal (India)	100	220.46	0.4593
Quintal (Mexico)	46.026	101.47	0.2114
Quintal (Peru, Spain)	46	101.41	0.2113
Long ton	1,016	2,240	4.666
Maund (Pakistan)	37.3242	82.286	0.1714
Picul (China)	50	110.23	0.2296

Bales			
Australia	227	500	1.04167
Colombia	233	514	1.0702
Egypt	327	720	1.5
India/Pakistan	170	375	0.7808
Mexico	230	507	1.05625
Nigeria	185	408	0.85
South Africa	200	441	0.9186
Sudan	191	420	0.875
United Rep. of Tanzania/Uganda	181	400	0.83333
United States	225	496	1.033

	Area	
	Acres	Hectares
Acre	1	0.4047
Dunams	0.2471	0.1
Feddan	1.038	0.42

Hectare	2.471	1
Manzana	1.72	0.696
Mu (China, 1/15 hectare)	0.1647	0.0667
Stremma (Greece, 1/10 hectare)	0.2471	0.1
Square metre	0.0002471	0.0001
Square mile	640	259

To convert from:	To:	Multiply by:
	Length	
Millimetre	32nd of an inch	1.25984
32nd of an inch	Millimetre	0.79375
Centimetre	Inch	0.3937
Centimetre	Millimetre	10
Inch	Centimetre	2.54
Inch	Millimetre	25.4
Foot (12 inches)	Centimetre	30.48
Metre	Inch	39.37
Metre	Yard	1.0936
Metre	Foot	3.2808
Yard (3 feet)	Metre	0.9144
Kilometre	Mile	0.6215
Mile (1,760 yards)	Kilometre	1.6093
	Yields	
Kilograms per hectare	Pounds per acre	0.8922
Cantar per feddan	Pounds per acre	106.19
Cantar per feddan	Kilogram per hectare	94.74
Quintal per manzana	Pounds per acre	58.971
Quintal per manzana	Kilograms per hectare	0.01696
Pounds per acre	Kilograms per hectare	1.121
Bales per acre	Pounds per acre	500
	Price	
Cents per pound	Dollars per ton	22.046
Dollars per ton	Cents per pound	0.04536
	Other	
Kilograms per square metre	Pounds per square yard	1.84336
Pounds per square yard	Kilograms per square metre	0.54249
Square metre	Square yard	1.19603
Square yard	Square metre	0.8361
Gram	Ounce	0.0353
	Yarn	

To convert from:	To:	Multiply by:
	Length	
Hank	Yard	840
Hank	Metre	768
Ne (English yarn count)	Nm (metric yarn count)	1.693
Nm (metric yarn count)	Ne (English yarn count)	0.591
Tex	= 1000/Nm	

Staple conversion chart			
Staple (inches)	United States code (32nds)	Decimals (HVI)	mm
1"	32	1.0 (0.99/1.01)	25.40
1-1/32"	33	1.03125 (1.02/1.04)	26.19
1-1/16"	34	1.0625 (1.05/1.07)	26.99
1-3/32"	35	1.09375 (1.08/1.10)	27.78
1-1/8"	36	1.125 (1.11/1.13)	28.58
1-5/32"	37	1.15625 (1.14/1.17)	29.37
1-3/16"	38	1.1875 (1.18/1.20)	30.16
1-7/32"	39	1.21875 (1.21/1.23)	30.96
1-1/4"	40	1.25 (1.24/1.26)	31.75
1-9/32"	41	1.28125 (1.27/1.29)	32.54
1-5/16"	42	1.3125 (1.30/1.32)	33.34
1-11/32"	43	1.34375 (1.33/1.35)	34.13
1-3/8"	44	1.375 (>1.36)	34.93
1-1/2"	48	1.5	38.10
1-5/8"	52	1.625	41.28
1-3/4"	56	1.75	44.45

Sources: Cotton Facts (CFC/ICAC); Bremen Cotton Exchange; Cotton Outlook.

Appendix III

Useful websites

These website addresses make up only a small sample of the vast and growing number of Internet sites providing useful information on cotton. The inclusion of a name on the list does not imply endorsement by ITC.

Many websites cover several categories of activities. The category under which they are listed here does not necessarily reflect their main line of activity.

International organizations

www.common-fund.org	CFC	Common Fund for Commodities
www.fao.org	FAO	Food and Agriculture Organization of the United Nations
www.icac.org	ICAC	International Cotton Advisory Committee
www.iccwbo.org	ICC	International Chamber of Commerce
www.ictsd.org	ITCSD	International Centre for Trade and Sustainable Development
www.imf.org	IMF	International Monetary Fund
www.imo.org	IMO	International Maritime Organization
www.iso.org	ISO	International Organization for Standardization
www.intracen.org	ITC	International Trade Centre UNCTAD/WTO
www.itf-commrisk.org	ITF	International Task Force on Commodity Risk Management in Developing Countries
www.itmf.org	ITMF	International Textile Manufacturers Federation
www.oecd.org	OECD	Organisation for Economic Co-operation and Development
www.unctad.org	UNCTAD	United Nations Conference on Trade and Development
www.unido.org	UNIDO	United Nations Industrial Development Organization
www.worldbank.org	WB	World Bank
www.wto.org	WTO	World Trade Organization

Cotton associations

www.abrapa.com.br	ABRAPA	Brazilian Cotton Producers Association
www.acsa-cotton.org	ACSA	American Cotton Shippers Association
www.afcot.org	AFCOT	Association française cotonnière
www.africancotton.org	A.C.A	Association cotonnière africaine
www.cottonafrica.com	ACTIF	African Cotton & Textile Industries Federation
www.alcotexa.org	ALCOTEXA	Alexandria Cotton Exporters Association
www.ampa.com.br	AMPA	Associação Mato-grossense dos Produtores de Algodão
www.aneacotton.com.br	ANEA	Brazil's Cotton Exporters Association
www.aproca.net	APROCA	Association des Producteurs de Coton Africains
www.austcottonshippers.com.au		Australian Cotton Shippers Association
www.baumwollboerse.de		Bremen Cotton Exchange

www.centroalgodonero.com	CAN	Centro Algodonero Nacional (Barcelona)
www.ccca.org	CCGA	California Cotton Growers and Ginners Associations
www.cicca.info	CICCA	Committee for International Co-operation between Cotton Associations
www.china-cotton.org	CCA	China Cotton Association
www.conalgodon.com	CONALGODON	Confederación Colombiana del Algodón
www.cotcorp.gov.in		The Cotton Corporation of India Ltd
www.cotton.org	NCC	National Cotton Council of America
www.cotton.org.pl	GCA	Gdynia Cotton Association
www.cottonaustralia.com.au		Cotton Australia
www.cottonboard.org		Cotton Board (USA)
www.cottoninc.com		Cotton Incorporated
www.cottonpromotion.org	IFCP	International Forum for Cotton Promotion
www.cottonsa.org.za	Cotton SA	Cotton South Africa
www.cottonusa.org	CCI	Cotton Council International (USA)
www.eica.in	EICA	Cotton Association of India
www.ica-ltd.org	ICA	The International Cotton Association Ltd (Liverpool)
www.kcapk.org	KCA	The Karachi Cotton Association
www.smi-ati.it	SMI-ATI	Federazione Imprese Tessili e Moda Italiene
www.southern cotton association.com		Southern Cotton Association
www.supimacotton.org	SUPIMA	Supima Association of America
www.tancotton.co.tz	TCB	Tanzania Cotton Board

International cotton merchants

www.allenberg.com		Allenberg Cotton Co.
www.amcot.org		America's Cotton Marketing Cooperatives
www.calcot.com	CALCOT	Calcot, Ltd
www.cargillcotton.com		Cargill Cotton
www.carolinascotton.com		Cotton Growers Cooperative
www.cotton.net		King Cotton Magazine (Weil Brothers Cotton)
www.dagris.fr	DAGRIS	Dagris SA, Compagnie Cotonnière SA (COPACO)
www.dunavant.com		Dunavant Enterprises, Inc.
www.ecomtrading.com	ECOM	Ecom Agroindustrial Corporation, Ltd
www.louis-dreyfus.com	LDCI	Louis Dreyfus Cotton International
www.olamonline.com		Olam
www.pcca.com	PCCA	Plains Cotton Cooperative Association
www.plainscotton.org	PCG	Plains Cotton Growers, Inc.
www.plexus-cotton.com		Plexus Cotton Limited
www.reinhart.com		Paul Reinhart AG
www.staplcotn.com		Staplcotn

Trading and prices

www.bnf.com.br	BM&F	Bolsa de Mercadorias & Futuros (Brazil Mercantile & Futures Exchange)
www.cftc.gov	CFTC	U.S. Commodity Futures Trading Commission
www.commodityseasonals.com		Practical Commodity Trading Advice and Information
www.cotlook.com		Cotton Outlook
www.cottonchina.org	CNCE	Beijing Cotton Outlook Consulting Limited
www.czce.com.cn	ZCE	Zhengzhou Commodity Exchange
www.futures.tradingcharts.com	TFC	Commodity Charts & Quotes International TradingCharts.com, Inc.

www.itb.org.tr		Izmir Mercantile Exchange
www.ncdex.com	NCDEX	National Commodity & Derivatives Exchange Ltd (India)
www.nybotlive.com	NYBOT	New York Board of Trade
www.searates.com		Sea freight rates
www.theice.com	ICE	IntercontinentalExchange
www.theseam.com		The Seam (online trading)
www.xe.com		Exchange rates

Research and education

www.crdc.com.au	CRDC	Cotton Research & Development Corporation (Australia)
www.cirad.fr	CIRAD	Centre de coopération internationale en recherche agronomique pour le développement (France)
http://cotton.memphis.edu	ACSA	International Cotton Institute
www.cotton.org/foundation		The Cotton Foundation
www.depts.ttu.edu/itc	ITC	International Textile Center (Texas Tech University)
www.fapri.missouri.edu	FAPRI	Food and Agricultural Policy Research Institute University of Missouri-Columbia
www.faserinstitut.de		Faserinstitut Bremen
www.ifpri.org	IFPRI	International Food Policy Research Institute
www.cottoncrc.org.au	CRC	Cotton Catchment Communities CRC (Australia)
www.odi.org.uk	ODI	Overseas Development Institute
www.sitra.org.in	SITRA	The South India Textile Research Association
www.texasintlcottonschool.com		Texas International Cotton School
www.wcr4.org	WCRC-4	World Cotton Research Conference-4 (Lubbock, TX 2007)

Sustainability and environment

www.bettercotton.org		Better Cotton Initiative
www.eco-forum.dk		EcoForum
www.ejfoundation.org/cotton		Environmental Justice Foundation
www.ewg.org	EWG	Environmental Working Group
www.fairtrade.net	FLO	Fairetrade Labelling Organizations International
www.global-standard.org		International Working Group on Global Organic Textile Standard
www.grain.org	GRAIN	NGO
www.ifdc.org	IFDC	An International Center for Soil Fertility & Agricultural Development
www.ifoam.org	IFOAM	International Federation of Organic Agriculture Movements
www.maketradeair.com		Make Trade Fair
www.maxhavelaar.org		Max Havelaar Federation
www.organicexchange.org	OE	Organic Exchange
www.oxfam.org	OXFAM	Oxfam International
www.sustainablecotton.org	SCP	Sustainable Cotton Project (California)

Other useful information

www.agweb.com		
www.ams.usda.gov/cotton	USDA	United States Department of Agriculture, Agricultural Marketing Service Cotton Program
www.balkan.com.tr		Balkan Textile & Cotton Gin Machinery Ltd

www.carcon.com		Cargo Control Group
www.cncotton.com	CNCotton	China Cotton & Textile Focus
www.coneagle.com		Continental Eagle Corp.
www.cotton.net		King Cotton Magazine
www.cotton-forum.org		EU - Africa Cotton Forum
www.cotton-international.com		Cotton International
www.cotton-net.com		Cotton on the net
www.cottonexperts.com		
www.cottongrower.com		Cotton Grower
www.cottonsjourney.com		
www.cottonspecialties.com		
www.deltaandpine.com		Delta & Pine Land Company
www.ers.usda.gov	ERS	United States Department of Agriculture, Economic Research Service
www.europa.eu.int	EU	European Union
www.fabricofourlives.com		
www.fas.usda.gov	USDA	United States Department of Agriculture, Foreign Agricultural Service
www.isscri.org	ISSCRI	Integrating Social Science Research into Cotton Reform Implementation Lined with the International Outlook
www.landofcotton.com		Land of Cotton news magazine
www.lummus.com		Lummus Corp.
www.monsanto.com		Monsanto
www.otexa.ita.doc.gov	OTEXA	Office of Textiles and Apparel (Department of Commerce – USA)
www.premier-1.com		Premier Evolvics Pvt. Ltd
www.ratescenter.org	RATES	USAID Regional Agricultural Trade Expansion Support Program
www.sgs.com	SGS	Société Générale de Surveillance
www.textileworld.com		Textile World News
www.thecottonrowjournal.com		The Cotton Row Journal
www.usda.gov/nass		National Agricultural Statistics Services (USA)
www.uster.com		Uster
www.wakefieldinspection.com	W.I.S.	Wakefield Inspection Services

ITC publications can be purchased from ITC's website: www.intracen.org/eshop and from:

- ▶ United Nations Sales & Marketing Section
Palais des Nations
CH-1211 Geneva 10, Switzerland
Fax: +41 22 917 00 27
E-mail: unpubli@unog.ch (for orders from Africa, Europe and the Middle East)

and

- ▶ United Nations Sales & Marketing Section
Room DC2-853, 2 United Nations Plaza
New York, N.Y. 10017, USA (for orders from America, Asia and the Far East)
Fax: 1/212 963 3489
E-mail: publications@un.org

Orders can be placed with your bookseller or sent directly to one of the above addresses.

ITC: The Development Partner for Export Success

ITC mission

ITC enables small business export success in developing countries by providing, with partners, sustainable and inclusive trade development solutions to the private sector, trade support institutions and policymakers.

ITC strategic objectives

- ▶ **Policymakers:** Support policymakers in integrating the business sector into the global economy.
- ▶ **Enterprises:** Strengthen the international competitiveness of enterprises.
- ▶ **Trade support institution:** Develop the capacity of trade service providers to support businesses.



International Trade Centre

U N C T A D / W T O

A joint technical cooperation agency of UNCTAD and WTO

For more information:

Street address: ITC, 54–56, rue de Montbrillant, 1202 Geneva, Switzerland.

Postal address: ITC, Palais des Nations, 1211 Geneva 10, Switzerland.

Telephone: +41 22 730 0111

Fax: +41 22 733 4439

E-mail: itcreg@intracen.org

Internet: www.intracen.org



9 789291 373529